



LIFEPAK[®] 15 MONITOR/DEFIBRILLATOR

Operating Instructions



LIFEPAK[®] 15 MONITOR/DEFIBRILLATOR

Operating Instructions

Important Information

!USA Rx Only

!USA Device Tracking

The U.S. Food and Drug Administration requires defibrillator manufacturers and distributors to track the location of their defibrillators. If the device is located somewhere other than the shipping address or the device has been sold, donated, lost, stolen, exported, destroyed, permanently retired from use, or if the device was not obtained directly from Physio-Control, please do one of the following: register the device at <http://www.physio-control.com>, call the device registration phone line at 1.800.426.4448, or use one of the postage-paid address change cards located in the back of this manual to update this vital tracking information.

Text Conventions

Throughout these operating instructions, special text characters (for example, **CAPITAL LETTERS** such as **CHECK PATIENT** and **SPEED DIAL**) are used to indicate labels, screen messages, and voice prompts.

Applicable Products

These operating instructions are for use with the following product catalog numbers.

REF

99577-001368, 99577-001372, 99577-001373, 99577-001588, 99577-001930, 99577-001931, 99577-001932, 99577-001933, 99577-001934, 99577-001935, 99577-001936, 99577-001937, 99577-001938, 99577-001939, 99577-001940, 99577-001941, 99577-001942, 99577-001943, 99577-001944, 99577-001945, 99577-001946, 99577-001947, 99577-001948, 99577-001949, 99577-001950, 99577-001951, 99577-001952, 99577-001953, 99577-001954, 99577-001955, 99577-001956, 99577-001957, 99577-001958, 99577-001959, 99577-001960, 99577-001961, 99577-001962, 99577-001963, 99577-001964, 99577-001965, 99577-001966

Physio-Control or its affiliates own, use, or have applied for the following trademarks or service marks: LIFEPAK, LIFEPAK CR, LIFEPAK EXPRESS, REDI-PAK, LIFENET, QUIK-LOOK, QUIK-COMBO, CODE SUMMARY, Shock Advisory System, CODE-STAT, DT EXPRESS, SunVue, and cprMAX. All other trademarks are trademarks of their respective owners or holders. The Oridion medical capnography in this product is covered by one or more of the following US patents: 6,428,483; 6,997,880; 5,300,859; 6,437,316 and their foreign equivalents. Additional patent applications pending. Specifications are subject to change without notice.



©2019 Physio-Control, Inc.
Publication Date: 01/2019

PN 3314911-011

Chapter 1 Preface	11
Introduction.....	13
Intended Use.....	13
Modes of Operation.....	14
Chapter 2 Safety Information	15
Terms	17
General Dangers and Warnings.....	17
Chapter 3 Basic Orientation	21
Front View	23
Back View	33
Batteries.....	35
Home Screen.....	37
Alarms.....	41
Options	43
Events	45
Chapter 4 Monitoring	47
Monitoring the ECG	49
Acquiring a 12-Lead ECG.....	61
Monitoring SpO ₂ , SpCO, and SpMet.....	71
Monitoring Noninvasive Blood Pressure	83
Monitoring ETCO ₂	91
Monitoring Invasive Pressure	99
Monitoring Continuous Temperature.....	107
Vital Sign and ST Segment Trends.....	111
Chapter 5 Therapy	117
General Therapy Warnings and Cautions.....	119
Therapy Electrode and Standard Paddle Placement	121
Automated External Defibrillation (AED).....	123
Manual Defibrillation	137
Synchronized Cardioversion Procedure.....	143
Noninvasive Pacing	148
Pediatric ECG Monitoring and Manual Mode Therapy Procedures.....	154

Chapter 6 Paddle Accessory Options	155
QUIK-COMBO Therapy Electrodes	157
Standard Paddles	160
Sterilizable Internal Defibrillation Paddles	164
Chapter 7 Data Management	165
Patient Records and Reports	167
Memory Capacity	173
Managing Current Patient Records	173
Managing Archived Patient Records	175
Chapter 8 Data Transmission	179
About Transmitting Patient Records and Reports	181
Preparing the Monitor for Transmission	182
Using Bluetooth Wireless Communication	182
Using a Direct Connection	187
Transmitting Reports	189
Considerations When Transmitting Data	191
Troubleshooting Tips	192
Chapter 9 Power Adapter	195
Basic Orientation	197
Using the Power Adapter	199
General Maintenance	202
Warranty	203
Chapter 10 Maintaining the Equipment	205
General Maintenance and Testing	207
Battery Maintenance	215
Cleaning the Device	218
Storing the Device	218
Loading Paper	219
General Troubleshooting Tips	220
Service and Repair	224
Service Life	224
Product Recycling Information	225

Warranty.....	225
Accessories.....	226
Appendix A Specifications and Performance Characteristics	229
Specifications and Performance Characteristics	231
Appendix B Screen Messages	253
Summary of Screen Messages.....	255
Appendix C Defibrillation Clinical Summaries	261
Defibrillation of Ventricular Fibrillation and Ventricular Tachycardia.....	263
External Cardioversion of Atrial Fibrillation.....	265
Intra-Operative Ventricular Defibrillation.....	269
Clinical Summary: Monophasic vs. Biphasic Waveforms: Out-of-Hospital Trial.....	272
Appendix D Shock Advisory System	275
Overview	277
Performance Verification	278
Appendix E SpO2 Specifications and Validation	283
SpO2 Specifications and Validation	285
Masimo Clinical Validation Data	293
Nellcor Clinical Validation Data.....	294
Appendix F Electromagnetic Compatibility Guidance	295
Electromagnetic Compatibility Guidance	297
Appendix G Symbols	303
Symbols	305
Index	311

Preface

This chapter provides a brief introduction to the LIFEPAK® 15 monitor/defibrillator and describes the product's intended use.

Introduction	13
Intended Use	13
Modes of Operation.....	14

Introduction

The LIFEPAK 15 monitor/defibrillator is a complete acute cardiac care response system designed for basic life support (BLS) and advanced life support (ALS) patient management protocols.

These operating instructions include information and procedures related to *all* features of the LIFEPAK 15 monitor/defibrillator. Your LIFEPAK 15 monitor/defibrillator may not have all of these features.

These operating instructions describe the operation of the LIFEPAK 15 monitor/defibrillator when the factory default settings are used. The factory default settings for all setup options are identified in table, Setup Options Factory Default Settings (on page 250). Your device may be set up with different default settings, based on your protocols. For information about changing default settings, see the *LIFEPAK 15 Monitor/Defibrillator Setup Options* provided with your device.

IMPORTANT! Some LIFEPAK 15 monitor/defibrillator accessories are *not* interchangeable with accessories that are used with other LIFEPAK monitor/defibrillators. Specific accessory incompatibilities are noted in the related sections.

Intended Use

The LIFEPAK 15 monitor/defibrillator is intended for use by trained medical personnel. For information about training options, contact your local Physio-Control representative.

The LIFEPAK 15 monitor/defibrillator can be used in out-of-doors and indoor emergency care settings within the environmental conditions specified in Appendix A. The monitor/defibrillator is designed to be used during ground transportation.

Monitoring and therapy functions may only be used on one patient at a time. Manual mode monitoring and therapy functions are intended for use on adult and pediatric patients. Automated external defibrillation mode is intended for use on patients eight years of age and older.

For additional intended use information, and information about the indications and contraindications of the monitoring and therapy functions, see the individual sections identified below.

- | | | |
|---|--|------------------|
| • ECG Monitoring | See Monitoring the ECG (on page 49) | Standard feature |
| • 12-Lead Electrocardiography | See Acquiring a 12-Lead ECG (on page 61) | Optional |
| • SpO ₂ , SpCO, and SpMet Monitoring | See Monitoring SpO ₂ , SpCO, and SpMet (on page 71) | Optional |
| • Noninvasive Blood Pressure Monitoring | See Monitoring Noninvasive Blood Pressure (on page 83) | Optional |
| • End-Tidal CO ₂ Monitoring | See Monitoring ETCO ₂ (on page 91) | Optional |

Modes of Operation

- | | | |
|-------------------------------------|---|------------------|
| • Invasive Pressure Monitoring | See Monitoring Invasive Pressure (on page 99) | Optional |
| • Temperature Monitoring | See Monitoring Continuous Temperature (on page 107) | Optional |
| • Vital Sign and ST Segment Trends | See Vital Sign and ST Segment Trends (on page 111) | Optional |
| • Automated External Defibrillation | See Automated External Defibrillation (AED) (on page 123) | Standard feature |
| • Manual Defibrillation | See Manual Defibrillation (on page 137) | Standard feature |
| • Noninvasive Pacing | See Noninvasive Pacing (on page 148) | Standard feature |

Modes of Operation

The LIFEPAK 15 monitor/defibrillator has the following modes of operation:

- **AED mode**—for automated ECG analysis and a prompted treatment protocol for patients in cardiac arrest.
- **Manual mode**—for performing manual defibrillation, synchronized cardioversion, noninvasive pacing, and ECG and vital sign monitoring.
- **Archive mode**—for accessing stored patient information.
- **Setup mode**—for changing default settings of the operating functions. For more information, see the *LIFEPAK 15 Monitor/Defibrillator Setup Options* provided with your device.
- **Demo mode**—for simulated waveforms and trend graphs for demonstration purposes.
- **Service mode**—for authorized personnel to perform diagnostic tests and calibrations. For more information, see the *LIFEPAK 15 Monitor/Defibrillator Service Manual*.

Safety Information

This chapter provides important information to help you operate the LIFEPAK 15 monitor/defibrillator. Familiarize yourself with all of these terms and warnings.

Terms.....	17
General Dangers and Warnings	17

Terms

The following terms are used either in these operating instructions or on the LIFEPAK 15 monitor/defibrillator:

Danger: Immediate hazards that will result in serious personal injury or death.

Warning: Hazards or unsafe practices that may result in serious personal injury or death.

Caution: Hazards or unsafe practices that may result in minor personal injury, product damage, or property damage.

General Dangers and Warnings

The following are general danger and warning statements. Other specific warnings and cautions are provided as needed in other sections of these operating instructions.

DANGER!

Explosion Hazard

Do not use this defibrillator in the presence of flammable gases or anesthetics.

WARNING

Shock Hazard

The defibrillator delivers up to 360 joules of electrical energy. Unless properly used as described in these operating instructions, this electrical energy may cause serious injury or death. Do not attempt to operate this device unless thoroughly familiar with these operating instructions and the function of all controls, indicators, connectors, and accessories.

WARNING

Shock Hazard

Do not disassemble the defibrillator. It contains no operator serviceable components and dangerous high voltages may be present. Contact authorized service personnel for repair.

WARNING

Possible Device Failure

Do not modify the device.

WARNING

Shock or Fire Hazard

Do not immerse any portion of this defibrillator in water or other fluids. Avoid spilling any fluids on defibrillator or accessories. Spilled liquids may cause the defibrillator and accessories to perform inaccurately or fail. Do not clean with ketones or other flammable agents. Do not autoclave or sterilize this defibrillator or accessories unless otherwise specified.

WARNING

Possible Fire

Use care when operating this device close to oxygen sources (such as bag-valve-mask devices or ventilator tubing). Turn off gas source or move source away from patient during defibrillation.

WARNING

Possible Electrical Interference With Device Performance

Equipment operating in close proximity may emit strong electromagnetic or radio frequency interference (RFI), which could affect the performance of this device. If use of equipment in close proximity is necessary, observe the device to verify normal operation in the configuration in which the device will be used. RFI may result in distorted ECG, incorrect ECG lead status, failure to detect a shockable rhythm, cessation of pacing, or incorrect vital sign measurements. Avoid operating the device near cauterizers, diathermy equipment, metal detectors, or electronic articles surveillance gates. Do not rapidly key EMS radios on and off. Refer to Electromagnetic Compatibility Guidance (on page 295) for recommended distances of equipment. Contact Physio-Control Technical Support if assistance is required.

WARNING

Possible Electrical Interference with Device Performance

Portable radio frequency (RF) communications equipment (including peripherals such as antenna cables and external antennas) should be used no closer than the distance listed in the Separation Distances (on page 300) table to any part of the LIFEPAK 15 monitor/defibrillator, including cables specified by Physio-Control. Shorter distances may result in compromised performance.

WARNING**Possible Electrical Interference**

This defibrillator should not be used adjacent to or stacked with other equipment. If adjacent or stacked use is necessary, the defibrillator should be observed to verify normal operation in the configuration in which it will be used.

WARNING**Possible Electrical Interference**

Using cables, electrodes, or accessories not specified for use with this defibrillator may result in increased emissions or decreased immunity from electromagnetic or radio frequency interference (RFI) which could affect the performance of this defibrillator or of equipment in close proximity. Use only parts and accessories specified in these operating instructions.

WARNING**Possible Electrical Interference**

This defibrillator may cause electromagnetic interference (EMI) especially during charge and energy transfers. EMI may affect the performance of equipment operating in close proximity. Verify the effects of defibrillator discharge on other equipment prior to using the defibrillator in an emergency situation, if possible.

WARNING**Possible Equipment Damage**

Use only ECG cables that are specified for use with this device. Protection of the device against defibrillator discharge is dependent on the use of ECG cables that are specified by Physio-Control.

WARNING**Possible Improper Device Performance**

Using other manufacturers' cables, electrodes, power adapters, or batteries may cause the device to perform improperly and may invalidate the safety agency certifications. Use only the accessories that are specified in these operating instructions.

WARNING**Possible Improper Device Performance**

Changing factory default settings will change the behavior of the device. Changes to the default settings must only be made by authorized personnel.

WARNING

Possible Device Shutdown

Always have immediate access to a spare, fully charged, properly maintained battery. Replace the battery when the device displays a low battery warning.

WARNING

Safety Risk And Possible Equipment Damage

MR unsafe: Keep the defibrillator away from magnetic resonance imaging (MRI) equipment.

WARNING

Possible Patient Burns

A defect in the neutral electrode connection on HF surgical equipment could cause burns at the lead or sensor site and damage to the monitor/defibrillator. Do not apply patient leads, sensors, or catheters when using high frequency (HF) electro-surgical equipment.

Note: The features of the LIFEPAK 15 monitor/defibrillator which could come in either direct or casual contact with the patient or caregiver during normal use are not made with natural rubber latex.

Basic Orientation

This chapter provides a basic orientation to the LIFEPAK 15 monitor/defibrillator device and its controls, indicators, and connectors.

Front View.....	23
Back View.....	33
Batteries	35
Home Screen.....	37
Alarms.....	41
Options	43
Events.....	45

Front View

This figure shows the front of the LIFEPAK 15 monitor/defibrillator. The front of the device is described in the following sections.

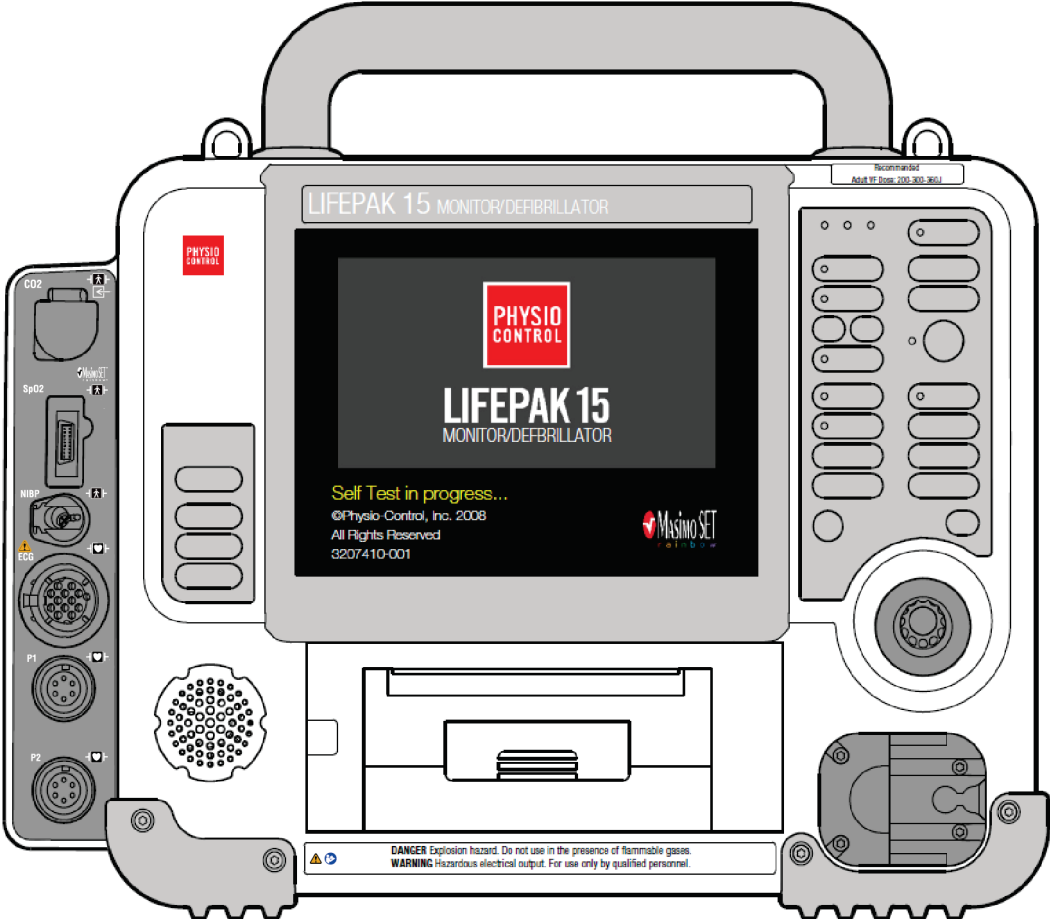

Figure 1 Front View

Area 1

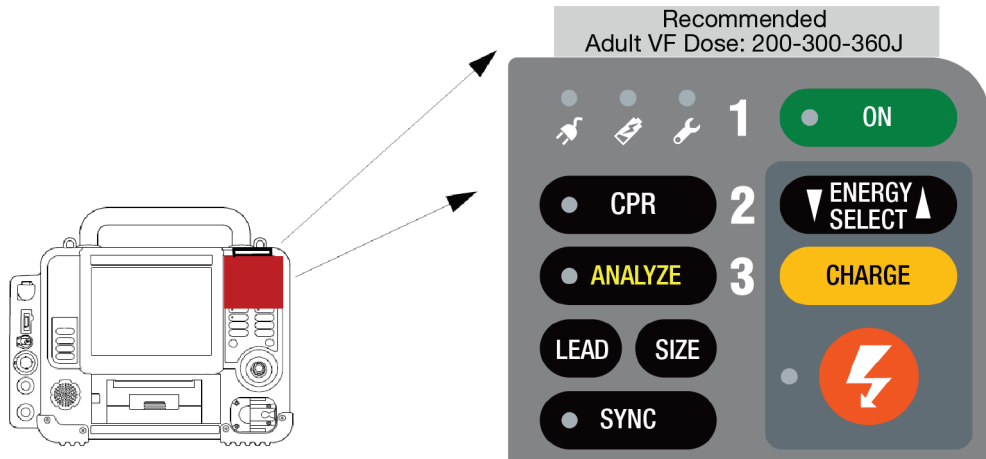





Figure 2 Area 1 Controls

Table 1 Area 1 Controls

CONTROL		DESCRIPTION	FOR MORE INFORMATION
	VF dose label	Physio-Control recommended energy dose for adult Ventricular Fibrillation (VF).	See <i>Biphasic Clinical Summaries</i> at www.physio-control.com/Biphasic
1	ON	Turns device ON or OFF. LED illuminated when ON. Press and hold to turn device off.	
2	ENERGY SELECT	Increases or decreases energy level in Manual mode.	See Manual Defibrillation (on page 137)
3	CHARGE	Charges the defibrillator in Manual mode.	See Manual Defibrillation (on page 137)
		Shock button. Initiates discharge of defibrillator energy to patient. LED flashes when charging is complete.	See Manual Defibrillation (on page 137)
		Auxiliary power indicator. LED illuminated when defibrillator is connected to auxiliary AC or DC power source, whether defibrillator is turned on or off.	See Using the Power Adapter (on page 199)
		Battery charging indicator. LED illuminated when installed batteries are fully charged. LED flashes when either battery is charging. LED is not illuminated when no batteries are installed or a battery is unable to be charged.	See AC Power Adapter Operation (on page 199)
		Illuminated Service LED indicates a condition exists that prevents or could prevent normal defibrillator operation.	See General Troubleshooting Tips (on page 220)
	CPR	Controls CPR metronome. LED illuminated when metronome function is active.	See Using the CPR Metronome (on page 141)
	ANALYZE	Activates Shock Advisory System™ (AED mode). LED illuminated when AED is analyzing the ECG, and flashes when user is prompted to push ANALYZE .	See Automated External Defibrillation (AED) (on page 123)
	LEAD	Changes ECG lead.	See Selecting ECG Lead (on page 50)
	SIZE	Changes ECG size.	See Changing ECG Size (on page 51)
	SYNC	Activates Synchronized mode. LED illuminated when Sync mode is active and flashes with detection of each QRS.	See Synchronized Cardioversion Procedure (on page 143)

Area 2

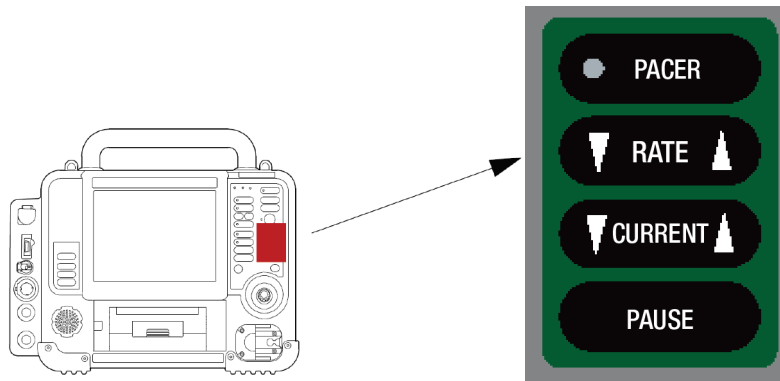

Figure 3 Area 2 Controls

Table 2 Area 2 Controls

CONTROL	DESCRIPTION	FOR MORE INFORMATION
PACER	Activates pacer function. LED illuminated when function is activated and flashes with each current pulse.	See Noninvasive Pacing (on page 148)
RATE	Increases or decreases pacing rate.	See Noninvasive Pacing (on page 148)
CURRENT	Increases or decreases pacing current.	See Noninvasive Pacing (on page 148)
PAUSE	Temporarily slows pacing rate.	See Noninvasive Pacing (on page 148)

Area 3

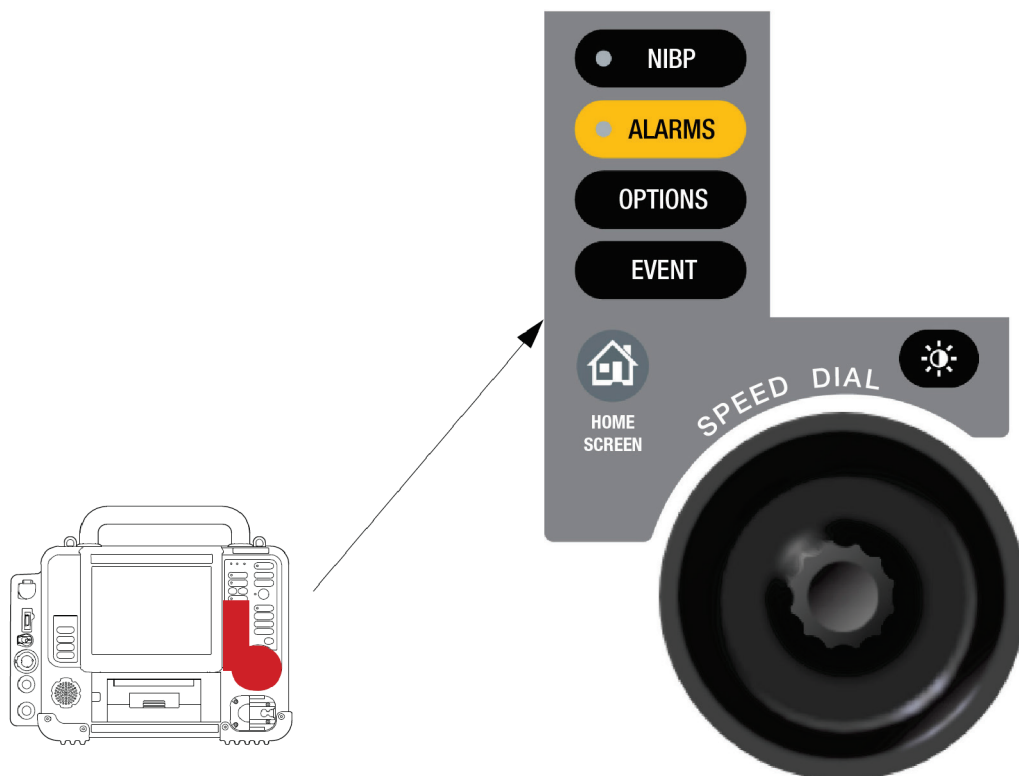



Figure 4 Area 3 Controls

Table 3 Area 3 Controls

CONTROL	DESCRIPTION	FOR MORE INFORMATION
NIBP	Initiates blood pressure measurement. LED illuminated when BP measurement is being obtained.	See Monitoring Noninvasive Blood Pressure (on page 83)
ALARMS	Activates and silences alarms. LED illuminated when alarms are enabled and flashes when an alarm condition occurs.	See Alarms (on page 41)
OPTIONS	Accesses optional functions.	See Options (on page 43)
EVENT	Accesses user-defined events.	See Events (on page 45)
HOME SCREEN	Returns to Home Screen display.	See Home Screen (on page 37)
SPEED DIAL	Scrolls through and selects screen or menu items.	See Navigating the Home Screen (on page 39)
	Display mode button switches between color display and high contrast SunVue™ display.	

Area 4

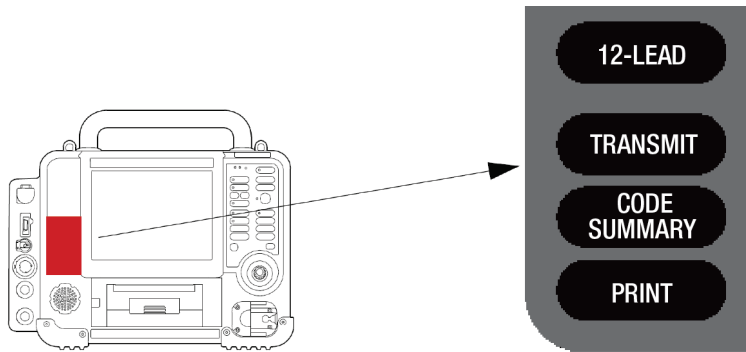

Figure 5 Area 4 Controls

Table 4 Area 4 Controls

CONTROL	DESCRIPTION	FOR MORE INFORMATION
12-LEAD	Initiates acquisition of 12-lead ECG.	See Acquiring a 12-Lead ECG (on page 61)
TRANSMIT	Initiates transmission of patient data.	See Transmitting Reports (on page 189)
CODE SUMMARY	Prints CODE SUMMARY™ critical event record.	See CODE SUMMARY Report (on page 168)
PRINT	Starts and stops printer.	See How to Print a Current Report (on page 173)

Area 5

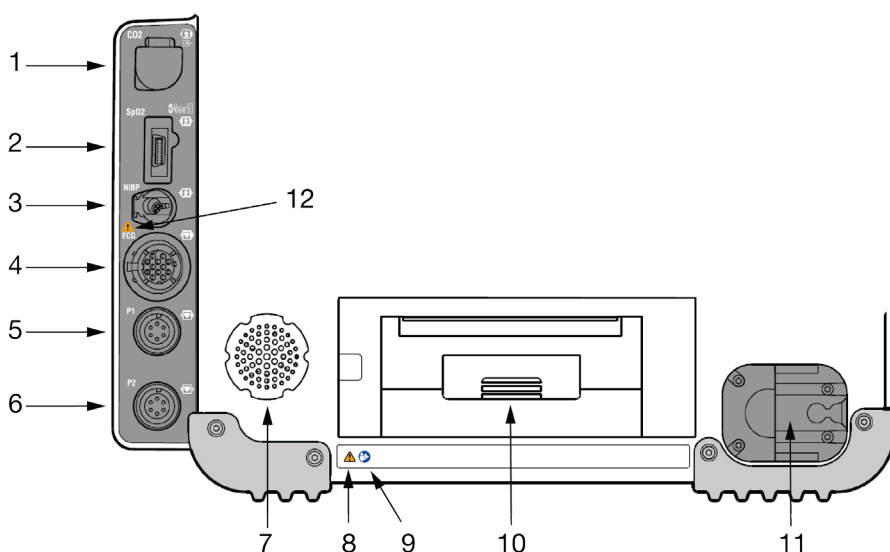

Figure 6 Area 5 Connectors, Speaker, and Printer

Table 5 Area 5 Connectors, Speaker, and Printer

ITEM	LABEL	DESCRIPTION	FOR MORE INFORMATION
1	CO2	FilterLine® set port	See Monitoring ETCO2 (on page 91)
2	SpO2/SpCO/ SpMet	Sensor cable port	See Monitoring SpO2, SpCO, and SpMet (on page 71)
3	NIBP	Pneumatic tubing port	See Monitoring Noninvasive Blood Pressure (on page 83)
4	ECG	Green electrically isolated ECG cable port	See Monitoring the ECG (on page 49)
5	P1	Invasive pressure cable port	See Monitoring Invasive Pressure (on page 99)
6	P2	Invasive pressure cable port	See Monitoring Invasive Pressure (on page 99)
7	Speaker	Projects device tones and voice prompts	
8	Symbol	General warning	See Warnings (on page 19)
9	Symbol	Follow instructions for use	
10	Printer	Door for 100 mm printer paper	See Loading Paper (on page 219)
11	Therapy cable receptacle	QUIK-COMBO® therapy cable and standard (hard) paddles cable receptacle	See Connecting and Disconnecting the Therapy Cable (on page 31)
12	Symbol	General warning	See Warnings (on page 19)

Note: If your LIFEPAK 15 monitor/defibrillator is configured for temperature monitoring, P1 and P2 are replaced by a single port labeled TEMP. For more information about temperature monitoring, see Monitoring Continuous Temperature (on page 107).

Connectors



	CONNECTOR ACTION
 <p>CO₂</p>	<p>Connect: Open CO₂ port door, insert FilterLine connector, and turn clockwise until connector is firmly seated.</p> <p>Disconnect: Rotate FilterLine connector counterclockwise and pull connector out.</p>
 <p>SpO₂</p>	<p>Connect: Align cable connector with SpO₂ port and push in until connector clicks into place.</p> <p>Disconnect: Press the gray buttons on each side of the cable connector simultaneously and pull connector out.</p>
 <p>NIBP</p>	<p>Connect: Insert NIBP tubing connector into the NIBP port.</p> <p>Disconnect: Press the latch on the left side of the port and pull tubing connector out.</p>
 <p>ECG</p>	<p>Connect: Align the green ECG connector with the ECG port; position the white line on the cable facing left. Insert the cable connector into the port until the connector is firmly seated.</p> <p>Disconnect: Pull the ECG connector straight out.</p>
 <p>P1</p> <p>P2</p>	<p>Connect: Align the IP (invasive pressure) cable connector with the P1 or P2 port; position the gap on the connector facing up. Insert the cable connector into the port until the connector is firmly seated.</p> <p>Disconnect: Grip the connector and pull straight out.</p>

Figure 7 Connectors for IP Monitoring Configuration

Note: If your LIFEPAK 15 monitor/defibrillator is configured for temperature monitoring, P1 and P2 are replaced by a single port labeled TEMP. For more information, see the following figure, Connectors for Temperature Monitoring Configuration.

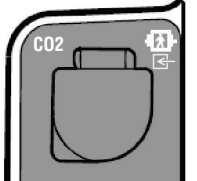

CONNECTOR ACTION	
 <p>CO₂</p>	<p>Connect: Open CO₂ port door, insert FilterLine connector, and turn clockwise until connector is firmly seated.</p> <p>Disconnect: Rotate FilterLine connector counterclockwise and pull connector out.</p>
 <p>SpO₂ SpCO/ SpMet</p>	<p>Connect: Align cable connector with SpO₂ port and push in until connector clicks into place.</p> <p>Disconnect: Press the gray buttons on each side of the cable connector simultaneously and pull connector out.</p>
 <p>NIBP</p>	<p>Connect: Insert NIBP tubing connector into the NIBP port.</p> <p>Disconnect: Press the latch on the left side of the port and pull tubing connector out.</p>
 <p>ECG</p>	<p>Connect: Align the green ECG connector with the ECG port; position the white line on the cable facing left. Insert the cable connector into the port until the connector is firmly seated.</p> <p>Disconnect: Pull the ECG connector straight out.</p>
 <p>TEMP</p>	<p>Connect: Align the temperature adapter cable connector with the TEMP port. Insert the cable connector into the port until the connector is firmly seated.</p> <p>Disconnect: Grip the connector and pull straight out.</p>

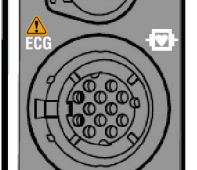
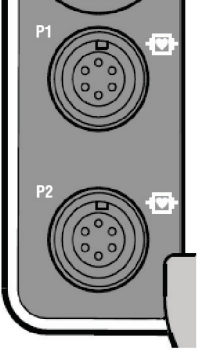
Figure 8 Connectors for Temperature Monitoring Configuration

Connecting and Disconnecting the Therapy Cable

WARNING

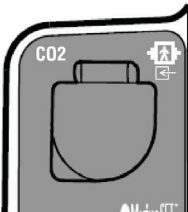
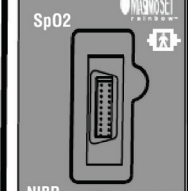
Possible Equipment Damage and Inability to Deliver Therapy

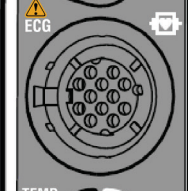
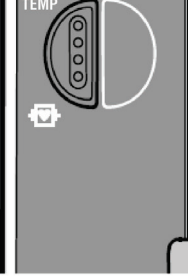
To help protect the therapy cable connector from damage or contamination, keep therapy cable connected to the defibrillator at all times. Inspect and test the therapy cable daily according to the Operator's Checklist in the back of this manual. Physio-Control recommends replacement of therapy cables every three years to reduce the possibility of failure during patient use.

IMPORTANT! The LIFEPAK 15 monitor/defibrillator QUIK-COMBO therapy cable and standard (hard) paddles have the same type of connector and connect to the defibrillator at the same location. These therapy cables are not compatible with other LIFEPAK defibrillator/monitors.

To connect a therapy cable to the defibrillator:

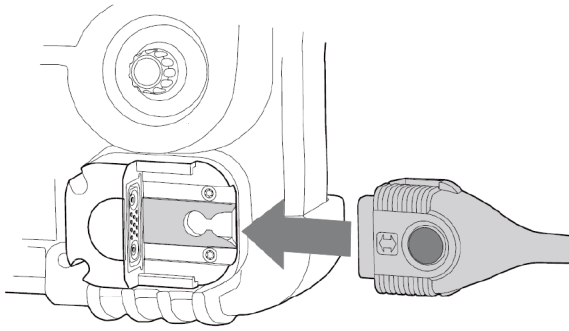

1. Align the therapy cable connector with the receptacle.
2. Slide the therapy cable until you feel the connector lock in place. You will also hear a “click.”

Figure 9 Connect Therapy Cable

To disconnect the therapy cable from the defibrillator:

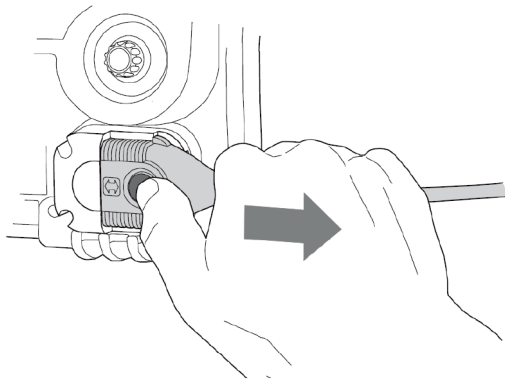

1. Press the release button on the therapy cable connector.
2. Slide the therapy cable connector out.

Figure 10 Disconnect Therapy Cable

Back View

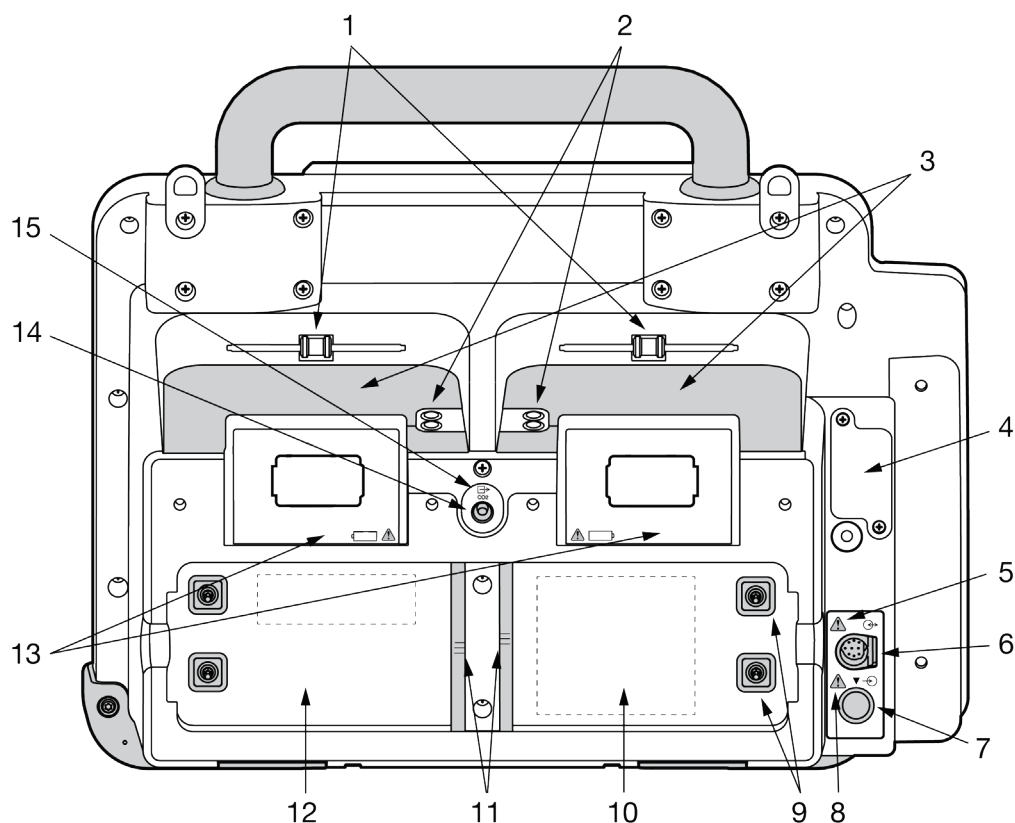

Figure 11 Back View

FIGURE LEGEND

1	Paddle retainers	9	Battery pins
2	Paddle test contacts	10	Battery well 1; includes serial number label
3	Standard paddle wells	11	Battery contacts
4	USB port cover	12	Battery well 2; includes <i>Bluetooth</i> label
5	See shock hazard warning (on page 34)	13	See battery warnings (on page 215) and stored battery warning (on page 216)
6	System connector	14	CO ₂ exhaust port
7	Auxiliary power connector	15	See EtCO ₂ monitoring warnings (on page 91)
8	See power adapter warnings (on page 198) and battery warnings (on page 215)		

Table 6 Back View

LABEL	DESCRIPTION	FOR MORE INFORMATION
Battery wells, pins, and contacts	<p>Each well holds one Lithium-ion battery. Two pins in each well transfer the battery power. Battery contacts transfer battery status information.</p> <p>See serial number label in battery well 1 for device part number, serial number, date of manufacture, and IP rating (dust and splash resistance).</p> <p>See <i>Bluetooth</i> label in battery well 2 for <i>Bluetooth</i> identification. See Using <i>Bluetooth</i> Wireless Communication for more information.</p>	See Battery Maintenance (on page 215)
CO ₂ exhaust port	Connects to a scavenger system when monitoring EtCO ₂ during use of anesthetics.	See Monitoring ETCO ₂ (on page 91)
Standard paddle wells, retainers, and test contacts	Paddle wells stow standard (hard) paddles. Retainers provide secure retention and quick removal of the paddles. Test contacts allow complete paddles defibrillation checks according to the Operator's Checklist.	See Standard Paddles (on page 160) and Operator's Checklist in the back of this manual
USB port cover	Protects USB port from the environment.	For future use
System connector	Connects device to a gateway or external computer for transfer of patient reports. Also provides real-time ECG output.	See Patient Records and Reports (on page 167)
Auxiliary power connector	Connects to an optional AC or DC power adapter. Allows use of auxiliary power source.	See Basic Orientation (on page 197)

WARNING

Shock Hazard

All equipment connected to the system connector must be battery powered or electrically isolated from AC power according to IEC 60601-1. If in doubt, disconnect the patient from the defibrillator before using the system connector. Only use Physio-Control recommended data transmission cables. For more information, contact Physio-Control Technical Support.

Note: To prevent inadvertent depletion of the defibrillator batteries, disconnect external devices from the system connector when not in use.

Batteries

The LIFEPAK 15 monitor/defibrillator operates either on battery power using two Lithium-ion batteries, or with auxiliary power using the AC Power Adapter or DC Power Adapter. Batteries may be charged in the Station or Mobile Li-ion Battery Charger, the REDI-CHARGE™ Battery Charger, or in the monitor/defibrillator if it is connected to auxiliary power.

Note: Although the monitor/defibrillator can operate using auxiliary power with no batteries installed, at least one battery must be installed at all times. If the monitor/defibrillator loses power for more than 30 seconds, the device reverts to the user-configured default settings and begins a new patient record.

IMPORTANT! The LIFEPAK 15 monitor/defibrillator Lithium-ion batteries are not interchangeable with batteries that are used in other LIFEPAK defibrillators.

Routinely inspect batteries for damage or leakage. Recycle or discard damaged or leaking batteries.

Each battery has a fuel gauge that indicates the approximate charge level in the battery. Press the gray button above the battery symbol to check the battery's charge level prior to installing it in the defibrillator. The four battery indicators shown here represent approximate charge—greater than 70%, greater than 50%, greater than 25%, and 25% or less, respectively.

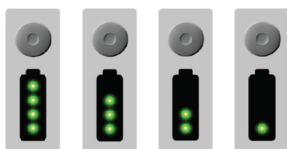

Figure 12 Battery Charge Indicators

Battery warning indicators are shown below. A single flashing LED indicates that the battery is very low and needs to be charged. Any two or more flashing LEDs indicate that the battery is faulty and should be returned to your authorized service personnel.

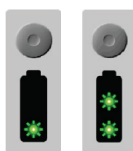

Figure 13 Battery Warning Indicators

Note: Older or heavily used batteries lose charge capacity. If a battery fuel gauge indicates fewer than four LEDs immediately after completing a charge cycle, the battery has reduced capacity. If the battery fuel gauge shows two or fewer LEDs after the battery completes a charge cycle, the battery should be replaced.

Batteries

To install a battery:

1. Confirm that the battery is fully charged, unless the battery will be charged in the monitor/defibrillator using the power adapter.
2. Inspect battery pins and contacts in the battery wells for signs of damage.
3. Align battery so battery clip is over the pins in the battery well.
4. Insert the end of the battery that is opposite the battery clip into the battery well.
5. Firmly press the clip end of the battery into the battery well until it clicks into place.
6. Repeat Step 1 through Step 5 to insert second battery.

To remove a battery, press the battery clip in and tilt the battery out of the battery well.

WARNING

Possible Loss of Power During Patient Care

Battery pins in the defibrillator may be damaged if batteries are dropped or forced into battery wells. Inspect pins routinely for signs of damage. Keep batteries installed at all times except when the device is removed from service for storage.

For information about battery maintenance, see Battery Maintenance (on page 215).

Home Screen

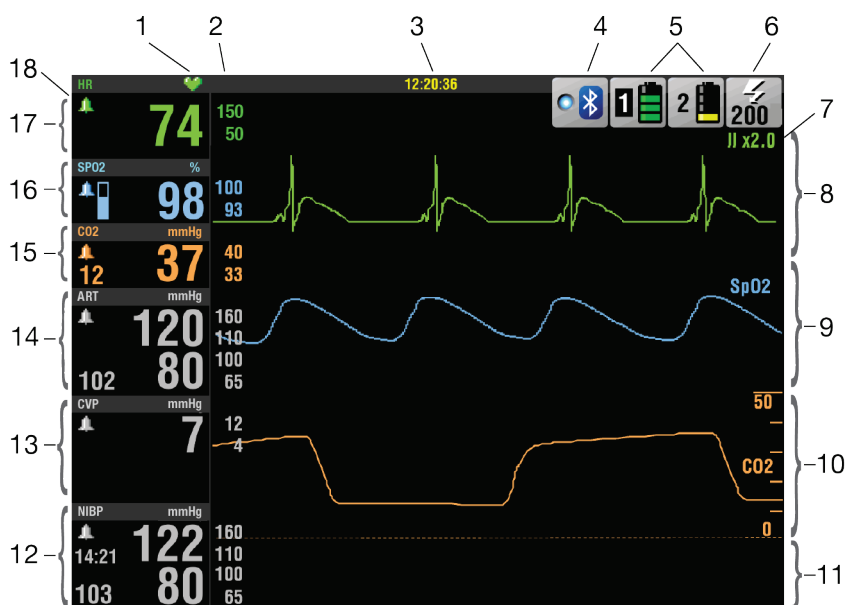

Figure 14 Home Screen

FIGURE LEGEND

1	Heart symbol	10	Channel 3
2	Alarm limits	11	Message area
3	Time	12	NIBP
4	Bluetooth icon	13	IP2
5	Battery indicator	14	IP1
6	Selected energy	15	EtCO ₂
7	ECG Lead/Size	16	SpO ₂ /SpCO/SpMet
8	Channel 1	17	Heart rate
9	Channel 2	18	Alarm indicator

The Home Screen is the main screen that displays ECG and other information. When a monitoring cable is attached to the device, the corresponding monitoring area on the screen is activated and the current patient values for that function are displayed. For example, when you connect an SpO₂ cable, the SpO₂ area is activated on the screen. SpO₂ values for the patient appear after the patient is connected. When the cable is disconnected, the SpO₂ patient values are replaced by dashes (--). Separate controls do not activate the monitoring functions, except for NIBP.

Each vital sign monitoring area is colored to match its waveform. This color scheme aids in associating the displayed waveform with its vital sign value. When a function does not have a waveform displayed, the vital sign area is gray.

WARNING**Failure to Detect a Change in ECG Rhythm**

Heart rate meters may count internal pacing pulses during cardiac arrest or some arrhythmias. Do not rely entirely on heart rate meter alarms. Keep pacemaker patients under close surveillance.

Table 7 Home Screen

AREA	DESCRIPTION	FOR MORE INFORMATION
Alarm limits	Limits display along the right side of the parameter.	See Alarms (on page 41)
Heart symbol	Flashes with detected QRS signals.	
Alarm indicator	Indicates whether alarms are on or silenced. Absence of indicator means alarms are off.	See Alarms (on page 41)
Heart rate	Device accurately detects and displays heart rates between 20 and 300 beats per minute (bpm). If patient's heart rate is below 20 bpm or above 300 bpm, or pacing is active, dashes (– –) appear. If ECG is not active, the SpO ₂ or NIBP monitor can display pulse rate, indicated by PR (SPO₂) or PR (NIBP) .	
SpO ₂ /SpCO/SpMet	Oxygen saturation level displays as a percentage from 50 to 100. Saturation below 50% displays as <50%. A fluctuating bar graph represents the pulse signal strength. When available and selected, the SpCO or SpMet value is displayed as a percent for 10 seconds, and then the SpO ₂ area reverts to the SpO ₂ reading.	See Monitoring SpO ₂ , SpCO, and SpMet (on page 71)
EtCO ₂	End-tidal CO ₂ level displays in mmHg, Vol%, or kPa. Respiratory rate (RR) displays in breaths per minute.	See Monitoring ETCO ₂ (on page 91)
IP1/IP2	Displays systolic, diastolic, and mean invasive pressures in mmHg. Two channels are available; default labels are P1 and P2. User-selectable labels include the following: <ul style="list-style-type: none"> • ART (arterial pressure) • PA (pulmonary artery pressure) • CVP (central venous pressure) • ICP (intracranial pressure) • LAP (left atrial pressure) 	See Monitoring Invasive Pressure (on page 99)
Temp	Displays skin, esophageal, rectal, or bladder temperature.	See Monitoring Continuous Temperature (on page 107)
NIBP	Displays systolic, diastolic, and mean arterial pressures (MAP) in mmHg, and time to next BP, when interval is set.	See Monitoring Noninvasive Blood Pressure (on page 83)

AREA	DESCRIPTION	FOR MORE INFORMATION
Time	Real or elapsed.	See <i>LIFEPAK 15 Monitor/Defibrillator Setup Options</i> provided with your device.
<i>Bluetooth</i> icon	Indicates <i>Bluetooth</i> capability. The LED is illuminated when a <i>Bluetooth</i> connection is established. Select this icon to access the <i>Bluetooth</i> setup menu.	See About Transmitting Patient Records and Reports (on page 181)
Battery indicator	Indicates presence of battery in battery well 1 and 2, relative level of charge, and battery in use.	See Battery Status Indicators (on page 40)
Selected energy	Selected defibrillation energy.	
ECG Lead/Size	Lead and size for ECG.	See Selecting ECG Lead (on page 50)
Channel 1	Displays the primary ECG waveform and is always visible.	See Selecting ECG Lead (on page 50)
Channel 2	Displays an additional waveform, a continuation of the Channel 1 ECG (cascading ECG), or a trend graph.	See Pleth Waveform (on page 78)
Channel 3	Displays an additional waveform or a trend graph.	See Displaying and Printing Trend Graphs (on page 115)
Message area	Displays up to two lines of status messages.	See Summary of Screen Messages

Navigating the Home Screen

Use the **SPEED DIAL** to navigate around the Home Screen. As you rotate the **SPEED DIAL**, the individual vital sign areas and waveform channels on the Home Screen are outlined. If you outline a vital sign area or channel and then press the **SPEED DIAL**, a menu appears.

For example, rotate the **SPEED DIAL** to outline Channel 3, and then press the **SPEED DIAL**. The following menu appears.

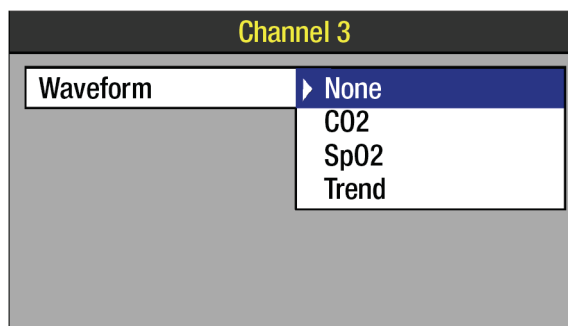

1. Rotate the **SPEED DIAL** to the desired setting.
2. Press the **SPEED DIAL** to select the setting.

Whenever a menu is displayed, the ECG is always visible in Channel 1. To return to the Home Screen from any menu, press the **HOME SCREEN** button.

Rotate and press the **SPEED DIAL** to select an option in a menu.

Battery Status Indicators





The Home Screen displays battery indicators that show the following information about the batteries installed in the defibrillator:

- Presence or absence of battery in battery well
- Battery in use
- Battery charge state

IMPORTANT! Always check the battery charge level and ensure batteries are adequately charged before use.

When two batteries are installed, the defibrillator uses the battery with the lowest level of charge first. The battery in use is indicated by a white battery number in a black box. When a battery reaches the replace battery state, the defibrillator automatically switches to the other battery. When all battery capacity is exhausted, the defibrillator turns off. If you insert a charged battery and repower the device in less than 30 seconds, the defibrillator retains its settings. The following table provides a description of the various battery status indicators.

Table 8 Battery Status Indicators

INDICATOR	MEANING	DESCRIPTION
	Active battery	The defibrillator is using the battery in well 1 for power. Battery status indicators display up to four green bars. Each green bar represents approximately 25% remaining charge. For example, three green bars indicate about 75% remaining charge.
	Low battery	Battery in well 1 is in use and is low. One yellow bar indicates 5% to 10% remaining charge.
	Very low battery	Battery in well 1 is in use and is very low. One red flashing bar indicates 0 to 5% remaining charge. The defibrillator automatically switches to the other battery only if adequate charge is available. If both batteries show red bars, the REPLACE BATTERY voice prompt occurs.
	Unrecognized battery	Battery in well 2 is not in use. Battery communication failed or a non-Physio-Control battery is installed. The battery may power the defibrillator but the level of charge is unknown and low battery messages and prompts will not occur.
	No battery installed or fault detected	No battery is installed in battery well 1, or a fault was detected in the battery in well 1 and the device will not use the battery.

Note: When the defibrillator is operating on auxiliary power using a power adapter, the battery indicators show the battery charge level, but the well numbers are not highlighted. The **LOW BATTERY** and **REPLACE BATTERY** messages and prompts do not occur when operating on auxiliary power.

Note: Older or heavily used batteries lose charge capacity. If a fully charged battery is installed in the defibrillator and the battery status indicator shows less than four bars, the battery has reduced capacity. If a battery status indicator shows only one or two bars after a fully charged battery is installed, the battery has less than half the normal use time and should be recycled.

Alarms

LIFEPAK 15 monitor/defibrillator alarms can be set up to be ON or OFF when the defibrillator is turned on. For more information, see the *LIFEPAK 15 Monitor/Defibrillator Setup Options* provided with your device.

When alarms are set up to be ON, default limits are set. The limits temporarily appear to the right of the active vital signs. For all vital sign default alarm limits, see Alarm Limits.

If alarms are set up to be OFF, press **ALARMS** to enable the alarms. Whether alarms are set up to be ON or are enabled by pressing **ALARMS**, they can only be turned off by pressing **ON** to turn off the device. If power is lost for less than 30 seconds, for example due to a system reset or changing the only active battery, alarm settings are restored automatically.

Setting Alarms

When you press **ALARMS**, the following menu appears:

Alarms	
Quick Set	
Limits	Wide
Silence	2 Min
VF/VT Alarm	Off

Select **QUICK SET** to activate the alarms for all active monitoring functions.

The Quick Set limits automatically set high and low limits based on the patient's current vital sign values. For example, if the patient's HR is 70, selecting **WIDE** results in a high limit of 110 and a low limit of 45; selecting **NARROW** results in a high limit of 100 and a low limit of 50. The default is **WIDE**.

Alarms	
Quick Set	
Limits	Wide
Silence	Narrow
VF/VT Alarm	

Select **LIMITS** to change alarm limits to **WIDE** or **NARROW**. See Alarm Limits.

Select **SILENCE** to turn off the audible alarm for up to 15 minutes. If an alarm limit is exceeded while the alarm is silenced, the violated vital sign flashes and an alarm message appears, but the alarm tone remains silent.

If alarms are silenced for more than two minutes, an alert tone of two quick beeps sounds every 2.5 minutes. If alarms are silenced for two minutes, the alert tone sounds after 60 seconds.

Note: The heart rate display and corresponding heart rate alarm should not be relied upon to provide an indication of ventricular fibrillation. Turn on the VF/VT alarm.

Alarms	
Quick Set	
Limits	Wide
Silence	Narrow
VF/VT Alarm	▶ Off

Select **VF/VT ALARM** to turn on continuous monitoring for ventricular fibrillation and ventricular tachycardia in Manual mode.



The VF/VT alarm indicator  appears above the primary ECG when the alarm is ON.

When the alarm is silenced or suspended, a red X appears across the indicator . Reselect **VF/VT** to turn off this alarm.

Note: When the **VF/VT ALARM** is ON, you are limited to **PADDLES** lead or Lead **II** in Channel 1. See Selecting ECG Lead (on page 50).

Note: The VF/VT alarm is suspended when the metronome is active, the noninvasive pacemaker is on, or when standard paddles are attached and **PADDLES** lead is selected. The alarm is also suspended when the monitor/defibrillator is charging or is charged.

Managing Alarms

The alarm bell symbol indicates when alarms are ON  or OFF . All alarms that are controlled by **QUICK SET** have equal priority. When alarms are ON and an alarm limit is exceeded, a tone sounds and the violated vital sign flashes.

To manage an alarm:

1. Press **ALARMS**. This silences the alarm for 2 minutes.

Note: After alarms are silenced by pressing the **ALARMS** button, an alert tone of two quick beeps sounds after 60 seconds.

2. Assess the cause of the alarm.
3. Assess the appropriateness of the limits settings (**WIDE** or **NARROW**).

If the patient is unstable, consider silencing the alarm for up to 15 minutes while attending to the patient. Do NOT reselect **QUICK SET**.

WARNING

Possible Failure to Detect an Out of Range Condition

Reselecting **QUICK SET** resets the alarm limits around the patient's current vital sign values, which may be outside the safe range for the patient.

4. After the patient is stable, reselect **QUICK SET**, if necessary.

When alarms are ON, you can silence them preemptively for up to 15 minutes.

To silence alarms preemptively:

1. Press **ALARMS**.
2. Select **SILENCE**.
3. Select **SILENCE** duration of 2, 5, 10, or 15 minutes.

The message **ALARMS SILENCED** appears in the message area at the bottom of the Home Screen. If alarms are silenced for more than two minutes, an alert tone of two quick beeps sounds every 2.5 minutes. If alarms are silenced for two minutes, the alert tone sounds after 60 seconds.

Note: When you select **SILENCE**, the VF/VT alarm is not silenced.

Options

Press **OPTIONS** to display the Options menu. Rotate the **SPEED DIAL** to scroll through the choices. Press the **SPEED DIAL** to make a selection.

Options	
Patient...	Archives...
Pacing...	Print...
Date/Time...	User Test
Alarm Volume...	

Table 9 Options Menu Selections

SELECTION	DESCRIPTION	FOR MORE INFORMATION
Patient	Enter patient name, patient ID, incident, age, and sex.	See Entering Patient Data (on page 44) in next section
Pacing	Select demand or nondemand pacing. Set internal pacer detection ON or OFF.	See Noninvasive Pacing (on page 148)
Date/Time	Set date and time. Cycle power for change to take effect.	See <i>LIFEPAK 15 Monitor/Defibrillator Setup Options</i> for time display options.
Alarm Volume	Adjust volume for alarms, tones, voice prompts and CPR metronome.	
Archives	Access archived patient records.	See Managing Archived Patient Records (on page 175)
Print	Select report, format, mode, and speed for printing a current patient report.	See How to Print a Current Report (on page 173)
User Test	Initiate device self-test.	See User Tests (on page 209)

Entering Patient Data

To enter patient data:

Options	
Patient...	Archives...
Pacing...	Print...
Date/Time...	User Test
Alarm Volume...	

- 1 Press **OPTIONS**.
- 2 Use the **SPEED DIAL** to select **PATIENT**.

Options / Patient	
Last Name...	▶
First Name...	
Patient ID...	
Incident...	
Age	
Sex	

- 3 Select **LAST NAME**, **FIRST NAME**, **PATIENT ID**, **INCIDENT**, **AGE**, or **SEX**. (**LAST NAME** is selected in the example.)

Options / Patient / Last Name		
Last Name: _____		
A	B C D E F G H I J K L M N O P Q R S T U V W X Y Z	
End		End
Space		Space
Backspace		Clear
0 1 2 3 4 5 6 7 8 9 -		

- 4 Rotate the **SPEED DIAL** to scroll through the characters and commands. Press the **SPEED DIAL** to make a selection. The selected character appears.
- 5 Repeat Step 4 until the name is complete.
- 6 Select **END**.
Three additional commands are available:
SPACE—inserts blank space.
BACKSPACE—deletes last character and moves selection back one space.
CLEAR—clears all characters.

Events

Use the Events menu to annotate patient events. A selected event appears in the Event log of the CODE SUMMARY critical event record. Events can be customized in Setup mode. For more information, see the *LIFEPAK 15 Monitor/Defibrillator Setup Options* provided with your device.

To select an event:

Events	
Generic	Intubation
Oxygen	CPR
IV Access	Epinephrine
Nitroglycerin	Atropine
Morphine	Lidocaine
Cancel Last	More...

1. Press **EVENT** to display the Events menu.
2. Rotate the **SPEED DIAL** to scroll through the choices. Press the **SPEED DIAL** to make a selection.
3. Select **MORE** to display additional event selections.

Generic 12:20:30

When an event is selected, the event and time stamp appear in the message area on the Home Screen.

Notes:

- If you highlight an event but do not select it and the menu times out, a Generic event and time stamp are annotated in the event log.
- If you highlight an event but do not select it and then press **HOME SCREEN**, a Generic event and time stamp are annotated in the event log.
- Select **CANCEL LAST** to indicate that an incorrect event was selected. A Cancel Last event and time stamp print in the event log.

Monitoring

This chapter describes the monitoring features of the LIFEPAK 15 monitor/defibrillator.

Monitoring the ECG.....	49
Acquiring a 12-Lead ECG	61
Monitoring SpO2, SpCO, and SpMet	71
Monitoring Noninvasive Blood Pressure.....	83
Monitoring ETCO2.....	91
Monitoring Invasive Pressure	99
Monitoring Continuous Temperature	107
Vital Sign and ST Segment Trends	111

Monitoring the ECG

Intended Use

The electrocardiogram (ECG) is a recording of the electrical activity of the heart. ECG monitoring allows for identification and interpretation of cardiac rhythms or dysrhythmias and calculation of heart rate. The ECG is obtained by placing either electrodes or paddles on the patient and allows the heart's electrical activity to be monitored and recorded.

ECG monitoring is a tool to be used in addition to patient assessment. Care should be taken to assess the patient at all times; do not rely solely on the ECG monitor.

ECG Monitoring Warning

WARNING**Possible Misinterpretation of ECG Data**

The frequency response of the monitor screen is intended only for basic ECG rhythm identification; it does not provide the resolution required for diagnostic and ST segment interpretation. For diagnostic or ST segment interpretation, or to enhance internal pacemaker pulse visibility, attach the multi-lead ECG cable. Then print the ECG rhythm in diagnostic frequency response (DIAG) or obtain a 12-lead ECG.

Selecting ECG Lead

The LIFEPAK 15 monitor/defibrillator includes two methods for selecting or changing the ECG lead.

To select or change the displayed ECG lead using the **LEAD** button:

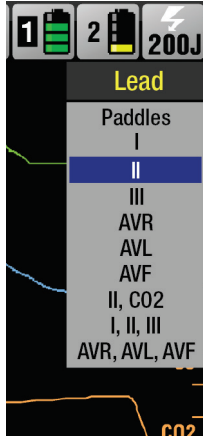

1. Press **LEAD**. If any ECG lead currently appears on the Home Screen, the lead changes to **PADDLES**. If **PADDLES** lead is currently displayed, the lead changes to Lead **II**.
2. While the **LEAD** menu is displayed, press **LEAD** again or rotate the **SPEED DIAL** to the desired lead.

Note: If lead sets are predefined for Channels 2 and 3, the lead sets show on the menu. The ECG cable that is connected to the device, such as 3-lead or 5-wire, determines the leads you can select. For information about defining lead sets, see the *LIFEPAK 15 Monitor/Defibrillator Setup Options* provided with your device.

To select or change the displayed ECG lead using the **SPEED DIAL**:

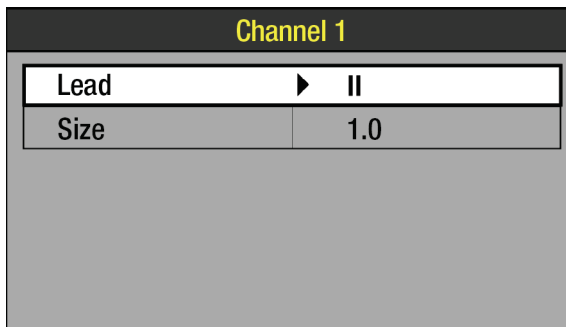

1. For the primary ECG, outline and select **CHANNEL 1** and then select **LEAD**.
2. Rotate the **SPEED DIAL** to the desired ECG lead.
3. Press the **SPEED DIAL** to select the ECG lead.
4. Repeat this procedure to select or change displayed ECG waveforms for Channels 2 and 3.

Note: The ECG shows dashed lines until the electrodes are connected to the patient.

Note: When the **VF/VT ALARM** is ON, you are limited to **PADDLES** lead or Lead **II** in Channel 1. See Setting Alarms (on page 41).

Changing ECG Size

The LIFEPAK 15 monitor/defibrillator includes two methods for selecting or changing ECG size.

To select or change the displayed ECG size using the **SIZE** button:

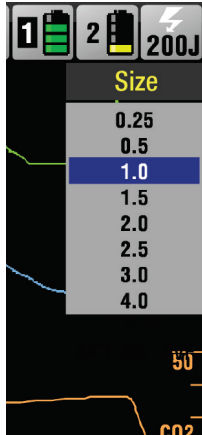

1. Press **SIZE**.
2. While the **SIZE** menu is displayed, press **SIZE** again or rotate the **SPEED DIAL** to the desired size.

To select or change the displayed ECG size using the **SPEED DIAL**:

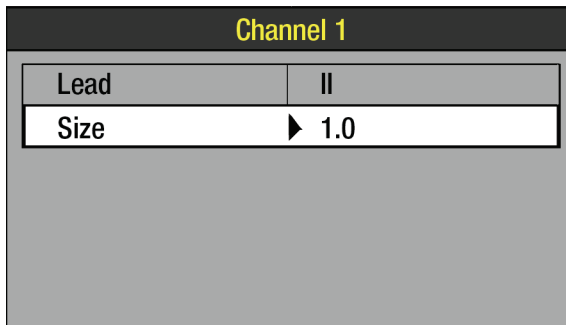

1. For the primary ECG, outline and select **CHANNEL 1** and then select **SIZE**.
2. Rotate the **SPEED DIAL** to the desired ECG size.
3. Press the **SPEED DIAL** to select the ECG size.

Adjusting the Systole Volume

To adjust the systole beep volume, use the **SPEED DIAL** to outline and select the **HR** area on the Home Screen.

The following menu appears:

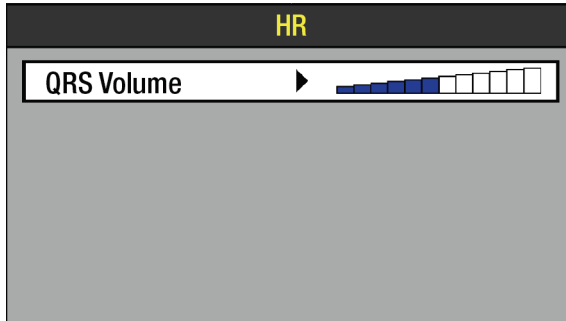

1. Press the **SPEED DIAL** to select **QRS VOLUME**.
2. Rotate the **SPEED DIAL** to the desired volume.
3. Press the **SPEED DIAL** to set the volume.

Note: The volume is reset to OFF each time the device is turned off.

Monitoring Using Paddle Accessories

To monitor ECG using paddles, you can use either QUIK-COMBO therapy electrodes or standard (hard) paddles. For more information about paddle accessories, see Paddle Accessory Options (on page 155).

Anterior-Lateral Placement

Anterior-lateral placement is the only placement that should be used for ECG monitoring using paddle accessories.

To place the therapy electrodes or paddles:

1. Place either the ♥ therapy electrode or **APEX** paddle lateral to the patient's left nipple in the midaxillary line, with the center of the electrode in the midaxillary line, if possible, as shown in the following figure.

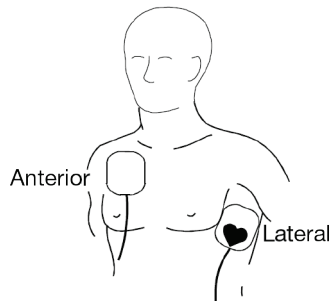

QUIK-COMBO Therapy Electrodes

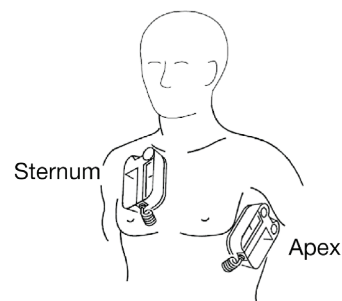

Standard Paddles

Figure 15 Anterior-Lateral Placement

2. Place the other therapy electrode or **STERNUM** paddle on the patient's upper right torso, lateral to the sternum and below the clavicle, as shown in the preceding figure.

Special Situations for Electrode or Paddle Placement

When placing therapy electrodes or standard paddles, be aware of the special requirements in the following possible situations:

Obese Patients or Patients with Large Breasts

Apply therapy electrodes or standard paddles to a flat area on the chest, if possible. If skin folds or breast tissue prevent good adhesion, it may be necessary to spread skin folds apart to create a flat surface.

Thin Patients

Follow the contour of the ribs and spaces when pressing the therapy electrodes or standard paddles onto the torso. This limits air spaces or gaps under the electrodes and promotes good skin contact.

Patients with Implanted Devices Such as Pacemakers or Defibrillators

If possible, place therapy electrodes or standard paddles away from implanted device.

Paddles ECG Monitoring Procedure

To monitor using standard paddles or therapy electrodes:

1. Press **ON**.
2. Prepare the patient's skin:
 - Remove all clothing from the patient's chest.
 - Remove excessive chest hair as much as possible. Avoid nicking or cutting the skin if using a shaver or razor. If possible, avoid placing electrodes over broken skin.
 - Clean and dry the skin, if necessary. Remove any medication patches and ointment on the patient's chest.
 - Briskly wipe the skin dry with a towel or gauze. This mildly abrades the skin and removes oils, dirt, and other debris for better electrode adhesion to the skin.
 - Do not use alcohol, tincture of benzoin, or antiperspirant to prep the skin.
3. Apply the standard paddles or therapy electrodes in the anterior-lateral position. For therapy electrodes, confirm that the package is sealed and the Use By date is not passed. For standard paddles, apply conductive gel over the entire electrode surface.
4. Connect the therapy electrodes to the therapy cable.
5. Select **PADDLES** lead.

Monitoring Using ECG Cable Accessories

The following ECG cables, shown in the figure, are available for ECG monitoring with the LIFEPAK 15 monitor/defibrillator:

- 12-lead (either of 2 types)
- 3-lead
- 4-wire
- 5-wire

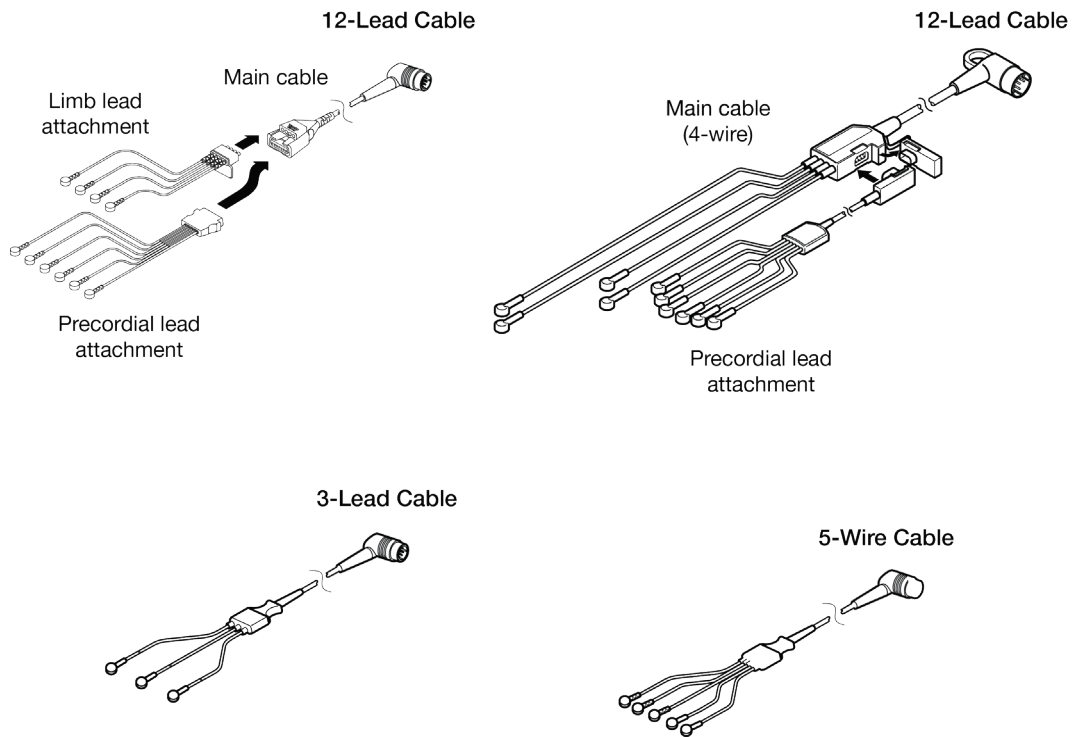
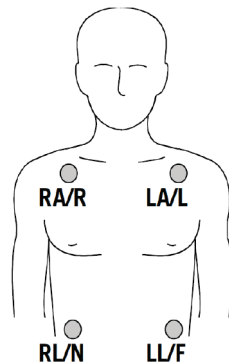

Figure 16 12-Lead, 3-Lead, 4-Wire, and 5-Wire ECG Cables

ECG Monitoring Procedure

To perform ECG monitoring:

1. Press **ON**.
2. Attach the ECG cable to the green connector on the monitor.
3. Identify the appropriate electrode sites on the patient as shown in the following figure.



AHA Labels

RA	Right Arm
LA	Left Arm
*RL	Right Leg
LL	Left Leg

IEC Labels

R	Right
L	Left
N	Negative
F	Foot

***Note:** Not used for 3-lead cable.

Figure 17 Limb Lead Electrode Placement

4. Prepare the patient's skin for electrode application:
 - Shave excessive hair at electrode site.
 - For oily skin, clean skin with alcohol pad.
 - Gently scrape skin to remove surface layer of dead cells and improve conduction of electrical signals.
 - Avoid locating electrodes over tendons and major muscle masses.
 - Clean and dry the skin.
5. Apply ECG electrodes:
 - Confirm that the package is sealed and the Use By date is not passed.
 - Attach an electrode to each of the lead wires.
 - Grasp electrode tab and peel electrode from carrier.
 - Inspect electrode gel and make sure gel is intact (discard electrode if gel is not intact).
 - Hold electrode taut with both hands. Apply the electrode flat to the skin. Smooth tape outwardly. Avoid pressing the center of the electrode.
 - Secure the trunk cable clasp to the patient's clothing.

Note: Ensure the electrodes do not contact any other conductive parts, including earth (ground).

Note: Electrode quality is critical for obtaining an undistorted ECG signal. Always check the date code on electrode packages for expiration date before using on a patient. Do not use electrodes that have expired. Disposable electrodes are intended for a single use.

6. Select the desired ECG lead on the monitor screen.
7. If necessary, adjust ECG size for accurate heart rate counting.
8. Press **PRINT** to obtain an ECG printout.

Precordial Lead ECG Monitoring

The precordial (chest) leads (see Table, ECG Leads Color Codes (on page 56)) can be used for monitoring when using the 12-lead cable or 5-wire cable.

To perform precordial lead ECG monitoring:

1. Insert the precordial lead attachment into the main cable as shown in Figure, 12-Lead, 3-Lead, 4-Wire, and 5-Wire ECG Cables (on page 54).
2. Place the precordial lead electrodes on the chest as described in the 12-lead ECG procedure and shown in Figure, Precordial Lead Electrode Placement (on page 62).

Note: When using a 5-wire cable, attach the limb leads as described in ECG Monitoring Procedure (on page 55), and place the C-lead electrode on the chest in the precordial position desired. Note that the LIFEPAK 15 monitor labels the ECG for this lead as V1 on the screen and printout, regardless of the location of the C-lead electrode.

Leads Off

If an electrode or lead wire disconnects during ECG monitoring, the monitor emits an audible alarm and displays a **LEADS OFF** message. The ECG trace becomes a dashed line. The alarm and messages continue until one of the following actions is performed:

- The lead wire is reconnected
- The lead selection is changed to a lead using connected lead wires
- Power is cycled.

Color Coding for ECG Leads

The lead wires and the electrode snaps for the patient ECG cable are color coded according to American Heart Association (AHA) or International Electrotechnical Commission (IEC) standards as listed in the following table.

Table 10 ECG Leads Color Codes

LEADS	AHA LABEL	AHA COLOR	IEC LABEL	IEC COLOR
Limb Leads	RA	White	R	Red
	LA	Black	L	Yellow
	RL	Green	N	Black
	LL	Red	F	Green
	C	Brown	C	Brown
Precordial Leads	V1	Red	C1	Red
	V2	Yellow	C2	Yellow
	V3	Green	C3	Green
	V4	Blue	C4	Brown
	V5	Orange	C5	Black
	V6	Violet	C6	Violet

Monitoring Patients Who Have Internal Pacemakers

The LIFEPAK 15 monitor/defibrillator internal pacemaker detection feature can be used to help identify internal pacemaker pulses on the printed ECG. When enabled, this feature uses lead V4 to detect internal pacemaker pulses. If V4 is not available because it is not attached or is too noisy, Lead II or Paddles Lead is used.

When the internal pacemaker detection feature is ON, the LIFEPAK 15 monitor/defibrillator annotates a hollow arrow  on the printed ECG if internal pacemaker pulses are detected. Patient history and other ECG waveform data, such as wide QRS complexes, should be used to verify the presence of an internal pacemaker. False annotations of this arrow may occur if ECG artifacts mimic internal pacemaker pulses. If false annotations occur frequently, deactivate the detection feature using the **OPTIONS / PACING / INTERNAL PACER** menu (see Options (on page 43)).

The LIFEPAK 15 monitor/defibrillator typically does not use internal pacemaker pulses to calculate the heart rate. However, when using therapy electrodes or standard paddles to monitor in **PADDLES** lead, the monitor may detect internal pacemaker pulses as QRS complexes, resulting in an inaccurate heart rate.

Large amplitude pacemaker pulses may overload the QRS complex detector circuitry so that no paced QRS complexes are counted. To help minimize ECG pickup of large unipolar pacemaker pulses, place ECG electrodes so the line between the positive and negative electrodes is perpendicular to the line between the pacemaker generator and the heart.

Smaller amplitude internal pacemaker pulses may not be distinguished clearly in **PADDLES** lead. For improved detection and visibility of internal pacemaker pulses, turn on the internal pacemaker detector function using the **OPTIONS / PACING / INTERNAL PACER** menu or connect the ECG cable, select an ECG lead, and print the ECG in diagnostic frequency response. For information about configuring internal pacemaker detection, see the Pacing Setup menu in the *LIFEPAK 15 Monitor/Defibrillator Setup Options* provided with your device.

Troubleshooting Tips

If problems occur while monitoring the ECG, check the table below for aid in troubleshooting. For basic troubleshooting problems, such as no power, see General Troubleshooting Tips (on page 220).

Table 11 Troubleshooting Tips for ECG Monitoring

OBSERVATION	POSSIBLE CAUSE	CORRECTIVE ACTION
Any of these messages displayed: CONNECT ELECTRODES CONNECT ECG LEADS ECG LEADS OFF XX LEADS OFF	Therapy electrodes not connected	<ul style="list-style-type: none"> Connect therapy electrode.
	One or more ECG electrodes disconnected	<ul style="list-style-type: none"> Connect ECG electrode.
	ECG cable is not connected to monitor	<ul style="list-style-type: none"> Connect ECG cable.
	Poor electrode-skin contact	<ul style="list-style-type: none"> Reposition cable or lead wires to prevent electrodes from pulling away from patient. Secure trunk cable clasp to patient's clothing. Prepare skin and apply new electrodes.
	PACER was pressed. The monitor automatically switched to Lead II, but ECG leads are not connected.	<ul style="list-style-type: none"> Connect ECG leads and initiate pacing.
Screen blank and ON LED illuminated	Broken ECG cable lead wire	<ul style="list-style-type: none"> Select another lead. Select PADDLES lead, and use standard paddles or therapy electrodes for ECG monitoring. Check ECG cable continuity.
	Screen not functioning properly	<ul style="list-style-type: none"> Print ECG on recorder as backup. Contact service personnel for repair.
Systole beeps not heard or do not occur with each QRS complex	Volume too low	<ul style="list-style-type: none"> Adjust volume.
	QRS amplitude too small to detect	<ul style="list-style-type: none"> Adjust ECG size.
Displayed heart rate (HR) different than pulse rate	ECG size set too high or too low	<ul style="list-style-type: none"> Adjust ECG size up or down.
	Monitor detecting the patient's internal pacemaker pulses	<ul style="list-style-type: none"> Change monitor lead to reduce internal pacemaker pulse size.
Displayed heart rate (HR) different from displayed ECG waveform	ECG size set too high or too low	<ul style="list-style-type: none"> Adjust ECG size up or down.
	Monitor detecting the patient's internal pacemaker pulses	<ul style="list-style-type: none"> Change monitor lead to reduce internal pacemaker pulse size.

OBSERVATION	POSSIBLE CAUSE	CORRECTIVE ACTION
Monitor displays dashes (---) instead of heart rate	Heart rate is < 20 bpm	<ul style="list-style-type: none"> Use ECG printout to calculate heart rate.
	Heart rate is > 300 bpm	<ul style="list-style-type: none"> Use ECG printout to calculate heart rate.
	Pacing function is active	<ul style="list-style-type: none"> No corrective action needed.
Poor ECG signal quality	Poor electrode-skin contact	<ul style="list-style-type: none"> Reposition cable or lead wires to prevent electrodes from pulling away from patient. Secure trunk cable clasp to patient's clothing. Prepare skin and apply new electrodes.
	Outdated, corroded, or dried-out electrodes	<ul style="list-style-type: none"> Check Use By date on electrode packages. Use only unexpired silver/silver chloride electrodes. Leave electrodes in sealed pouch until time of use.
	Loose connection. Damaged cable or connector/lead wire	<ul style="list-style-type: none"> Check or reconnect cable connections. Inspect ECG and therapy cables. Replace if damaged. Check cable with simulator and replace if malfunction observed.
	Noise because of radio frequency interference (RFI)	<ul style="list-style-type: none"> Check for equipment causing RFI (such as a radio transmitter) and relocate or turn off equipment power.
Baseline wander (low frequency/high amplitude artifact)	Inadequate skin preparation	<ul style="list-style-type: none"> Prepare skin and apply new electrodes.
	Poor electrode-skin contact	<ul style="list-style-type: none"> Check electrodes for proper adhesion.
	Diagnostic frequency response	<ul style="list-style-type: none"> Print ECG in monitor frequency response.
Fine baseline artifact (high frequency/low amplitude)	Inadequate skin preparation	<ul style="list-style-type: none"> Prepare skin and apply new electrodes.
	Isometric muscle tension in arms/legs	<ul style="list-style-type: none"> Confirm that limbs are resting on a supportive surface. Check electrodes for proper adhesion.

Monitoring the ECG

OBSERVATION	POSSIBLE CAUSE	CORRECTIVE ACTION
ECG amplitude too small	Poor electrode-skin contact	<ul style="list-style-type: none"> Prepare skin and apply new electrodes.
	ECG lead selected	<ul style="list-style-type: none"> Increase ECG gain or change ECG lead.
	Patient condition (for example, significant myocardial muscle loss or tamponade)	<ul style="list-style-type: none"> Increase ECG gain or change ECG lead.
Monitor displays dashed lines with no ECG LEADS OFF messages	PADDLES lead selected but patient connected to ECG cable	<ul style="list-style-type: none"> Select one of the limb or precordial leads.
Monitor shows isoelectric (flat) line and PADDLES lead selected	The Test Load is connected to therapy cable	<ul style="list-style-type: none"> Remove the Test Load and connect therapy electrodes to cable. Connect ECG cable and select another lead.
Internal pacemaker pulses difficult to see	Pacemaker pulses are very small	<ul style="list-style-type: none"> Turn on internal pacemaker detector (see Monitoring Patients Who Have Internal Pacemakers (on page 57)).
	Monitor frequency response limits visibility	<ul style="list-style-type: none"> Connect ECG cable and select a lead other than PADDLES. Print ECG in Diagnostic mode (see How to Print a Current Report (on page 173)).

For general troubleshooting tips, see General Troubleshooting Tips (on page 220).

Acquiring a 12-Lead ECG

Intended Use

The 12-lead ECG offers paramedics and emergency physicians significant advantages over the single lead ECG trace typically available in EMS. The 12-lead ECG not only provides a diagnostic quality ECG for use in the detection of ST elevation myocardial infarction (STEMI), but also allows the knowledgeable paramedic to determine the area of myocardial injury, anticipate associated potential complications, and implement treatment strategies accordingly. In addition, the 12-lead ECG provides a baseline for serial ECG evaluations.

The 12-lead ECG transmission to the emergency department (ED) is recommended by the AHA and ERC for patients with Acute Coronary Syndrome (ACS). When transmitted from the field, 12-lead ECG has been shown to shorten time to in-hospital treatment by an estimated 10 to 60 minutes. Patients may also benefit from triage and transport to the most appropriate facility. Documentation of transient or intermittent arrhythmias and other electrophysiologic events that occur in the prehospital setting can assist in diagnosis and treatment decisions in the ED.

Indications

The 12-lead electrocardiogram is used to identify, diagnose, and treat patients with cardiac disorders and is useful in the early detection and prompt treatment of patients with acute ST-elevation myocardial infarction (STEMI).

Contraindications

None known.

12-Lead ECG Warning

WARNING

Possible Inability to Obtain a Diagnostic 12-lead ECG

Using previously unpackaged electrodes or electrodes past the Use By date may impair ECG signal quality. Remove electrodes from a sealed package immediately before use and follow the procedure for applying the electrodes.

Identifying Electrode Sites

To obtain a 12-lead ECG, place the electrodes on the limbs and the chest (precordium) as described in the following paragraph.

Limb Lead Electrode Sites

When acquiring a 12-lead ECG, limb lead electrodes are typically placed on the wrists and ankles as shown in the following figure. The limb lead electrodes can be placed anywhere along the limbs. Do not place the limb lead electrodes on the torso when acquiring a 12-lead ECG.

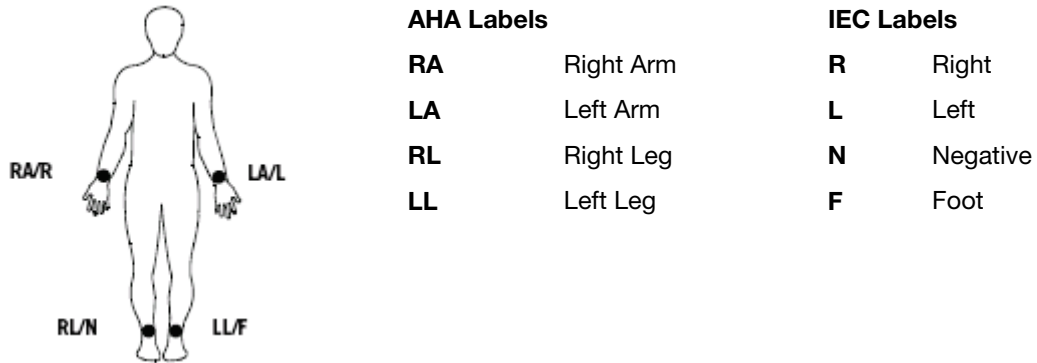

Figure 18 Limb Lead Electrode Placement for 12-Lead ECG

Precordial Lead Electrode Sites

The six precordial (chest) leads are placed on specific locations as shown and summarized in the following figure. Proper placement is important for accurate diagnosis and should be identified as follows: leads are V1 through V6 for AHA, or C1 through C6 for IEC. See ECG Leads Color Codes (on page 56) for color codes.

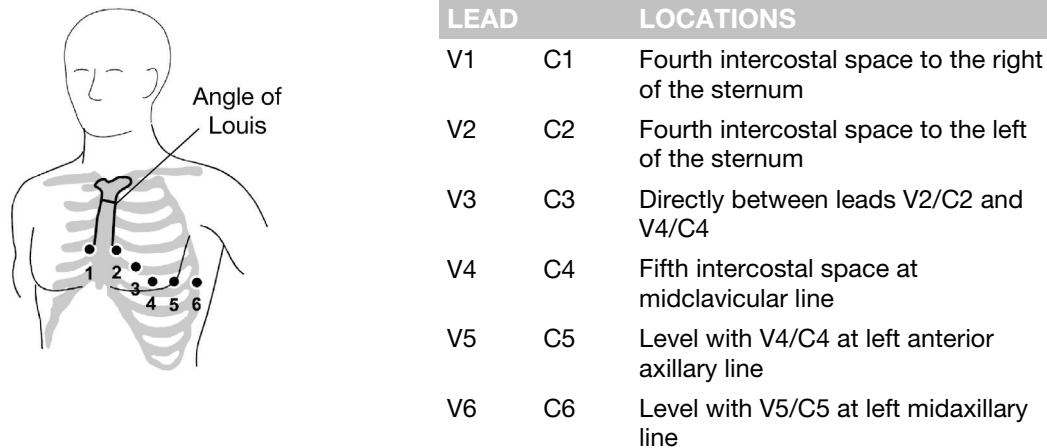

Figure 19 Precordial Lead Electrode Placement

Locating the V1/C1 position (fourth intercostal space) is critically important, because it is the reference point for locating the placement of the remaining V/C leads.

To locate the V1/C1 position:

1. Place your finger at the notch in the top of the sternum.
2. Move your finger slowly downward about 3.8 centimeters (1.5 inches) until you feel a slight horizontal ridge or elevation. This is the Angle of Louis where the manubrium joins the body of the sternum.
3. Locate the second intercostal space on the patient's right side, lateral to and just below the Angle of Louis.
4. Move your finger down two more intercostal spaces to the fourth intercostal space, which is the V1/C1 position.
5. Continue locating other positions from V1/C1 (see the preceding figure).

Other important considerations:

- When placing electrodes on female or obese patients, always place leads V3-V6 and C3-C6 *under* the breast rather than *on* the breast.
- Never use the nipples as reference points for locating the electrodes for men or women patients, because nipple locations vary widely.

12-Lead ECG Procedure

To acquire a 12-lead ECG:

1. Press **ON**.
2. Insert the lead attachments into the main cable as shown in the following figure.

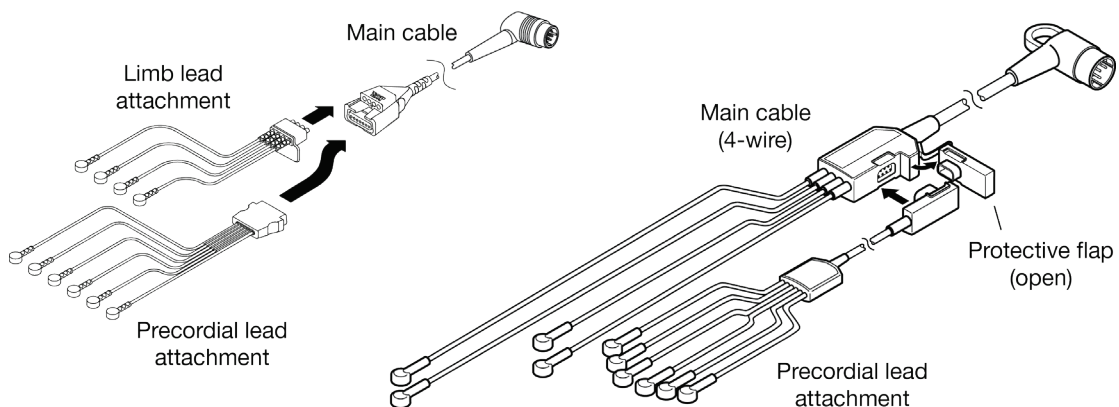

Figure 20 12-Lead ECG Cables

3. Insert the cable connector into the green ECG connector on the monitor.
 4. Prepare patient's skin for electrode application (see ECG Monitoring Procedure (on page 55)).
 5. Apply ECG electrodes (see Limb Lead Electrode Sites (on page 62)).
 6. Encourage the patient to remain as still as possible.
-

WARNING

Possible Inaccurate Diagnosis

If age and sex are not entered when a 12-lead ECG is obtained, the interpretive statements are based on a default of a 50-year-old male and may provide incorrect analysis for that patient.

7. Press **12-LEAD**. The **12-LEAD / AGE** menu appears, prompting you to enter the patient's age.

Use the **SPEED DIAL** to select the age. Always enter the patient's age if the patient is 15 years old or younger. If you do not enter an age, the default value of 50 years is used by the interpretive analysis program and annotated on the 12-lead ECG report.

8. The **12-LEAD / SEX** menu appears, prompting you to enter the patient's sex.

Use the **SPEED DIAL** to select the patient's sex. If you do not enter the sex, the default of male is used by the interpretive analysis program and is annotated on the 12-lead ECG report.

The monitor acquires, analyzes, and automatically prints the 12-lead ECG. An ECG leads-off condition for any lead is indicated on the report by a dashed line.

Notes:

- If 15 years or less is entered for patient age, the 12-lead ECG prints at diagnostic frequency response of 0.05–150 Hz, even when 0.05–40 Hz is set up as the print default.
- When **12-LEAD** is pressed, internal pacemaker detection is automatically enabled, even if the function is set up to be OFF.
- The 12-Lead ECG function is not available while in AED mode.

ECG Override

If the monitor detects signal noise while acquiring data (such as patient motion or a disconnected electrode), the screen displays the message: **NOISY DATA! PRESS 12-LEAD TO ACCEPT**. The message remains and 12-lead ECG acquisition is interrupted until noise is eliminated. Take appropriate action to eliminate the signal noise. This message remains as long as signal noise is detected. When signal noise is eliminated, the monitor resumes acquiring data. To override the message and acquire the 12-lead ECG in spite of the signal noise, press **12-LEAD** again. The 12-lead ECG will be acquired and printed with no interpretive statements. Any 12-lead ECG report acquired in this way is annotated with the following statement: **ECG OVERRIDE: DATA QUALITY PROHIBITS INTERPRETATION**.

If the signal noise persists for longer than 30 seconds, 12-lead ECG acquisition stops. The screen displays **EXCESSIVE NOISE–12-LEAD CANCELLED**. You must then press **12-LEAD** to restart 12-lead ECG acquisition.

Note: If **12-LEAD** is pressed immediately after ECG electrodes are applied, the message **NOISY DATA** may occur. This message is due to the temporary instability between the electrode gel and the patient's skin that is not viewable on the ECG monitor screen, but is detected as noisy data. In general, it is best to wait at least 30 seconds after applying the last electrode before pressing the **12-LEAD** button, to allow for electrode/skin stabilization. Also, good skin preparation shortens the stabilization time.

Computerized ECG Analysis

Computerized ECG analysis statements are automatically printed on 12-lead ECG reports. Printing of the interpretive statements is a setup option and may be turned off in Setup mode. For information on how to change this setup option, see the *LIFEPAK 15 Monitor/Defibrillator Setup Options* provided with your device.

The interpretative statements pertaining to myocardial injury, infarct, and ischemia are derived from measurements made on a signal-averaged beat (median beat) formed for each of the 12 leads. The computerized ECG analysis selects three representative beats from the ten seconds of data for each lead and averages the three beats to derive the median beat for that lead. The ECG analysis is always based on ECG data obtained at 0.05–150 Hz frequency response.

The analysis program is adjusted for patient age and sex. The 12-lead ECG interpretive algorithm used by the LIFEPAK 15 monitor/defibrillator is the University of Glasgow 12-Lead ECG Analysis Program. For more information, contact your Physio-Control representative for a copy of the *Physio-Control Glasgow 12-Lead ECG Analysis Program Physician's Guide*.

WARNING

Possible Incorrect Treatment with Reperfusion Therapy

Computerized ECG interpretive statements should not be used to withhold or prescribe patient treatment without review of the ECG data by qualified medical personnel. All 12-lead ECG interpretation statements provided by the LIFEPAK 15 monitor/defibrillator include the printed message ****UNCONFIRMED****. Always confirm interpretive statements by over-reading the ECG data.

Printed 12-Lead ECG Report Formats

Two 12-lead ECG report formats are available for printing: 3-channel or 4-channel. In addition, each of those formats can be printed in standard and cabrera styles.

3-Channel Format

The 3-channel format prints 2.5 seconds of data for each lead. The following figure is an example of a 12-lead ECG report printed in the 3-channel format, standard style. The following figure is an example of a 12-lead ECG report printed in the 3-channel format, cabrera style. The sequence in which the limb leads are presented differs between the standard and cabrera styles, as shown. The default format for printing 12-lead ECG reports is 3-channel standard. To change the printed format of 12-lead ECG reports, see the *LIFEPAK 15 Monitor/Defibrillator Setup Options* provided with your device. Alternatively, press **OPTIONS**, select **PRINT**, select **REPORT: 12-LEAD**, and then select **FORMAT**.

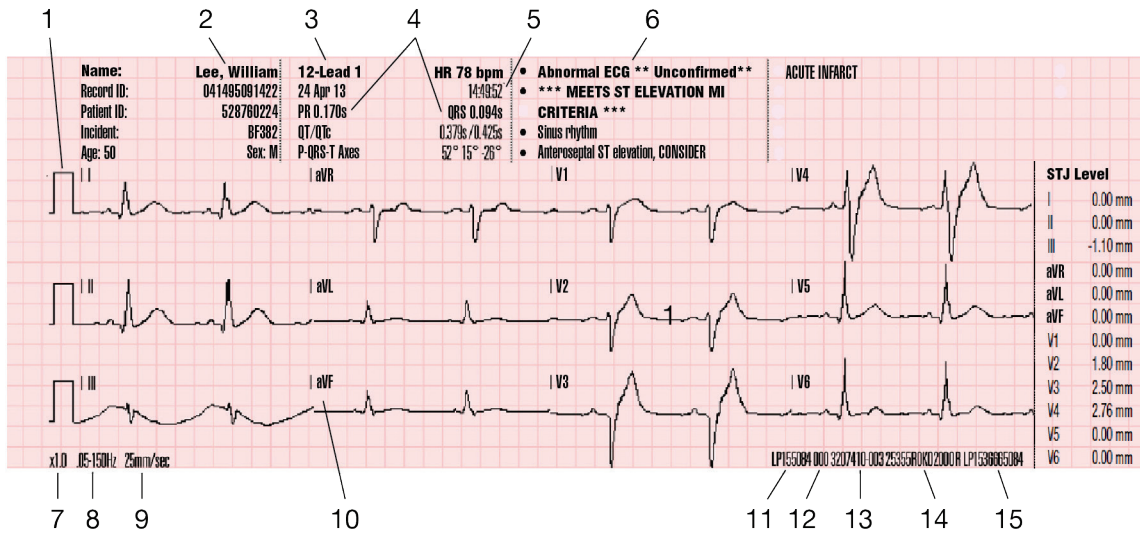

Figure 21 Example of Printed 3-Channel, Standard 12-Lead ECG Report

FIGURE LEGEND

- | | | | |
|---|----------------------------|----|--------------------|
| 1 | 1 mV reference | 9 | Printer speed |
| 2 | Patient ID | 10 | Lead annotation |
| 3 | Report type and number | 11 | Device number |
| 4 | Standard measurement | 12 | Site number |
| 5 | Time/date 12-lead acquired | 13 | Software version |
| 6 | Computerized ECG analysis | 14 | Configuration code |
| 7 | ECG size | 15 | Serial number |
| 8 | Frequency response | | |

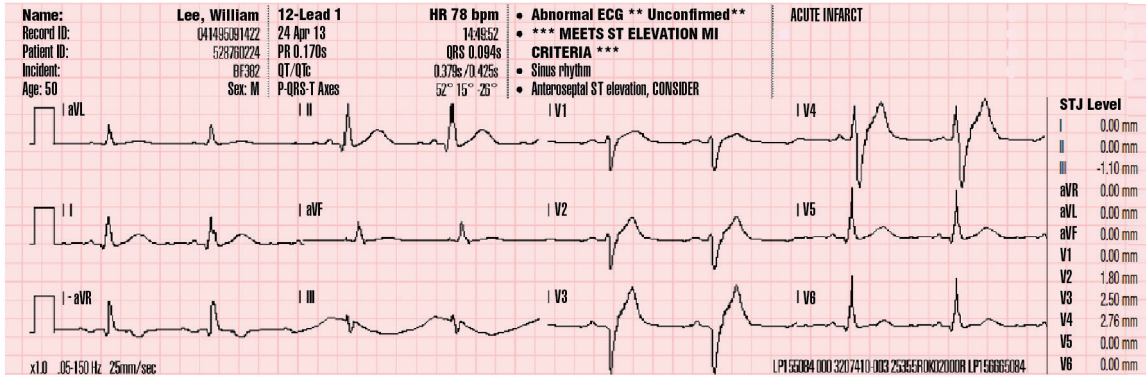

Figure 22 Example of Printed 3-Channel, Cabrera 12-Lead ECG Report

4-Channel Format

The following two figures are examples of 12-lead ECG reports printed in the 4-channel format. The 4-channel format consists of the median complex (or median beat) derived for each of the 12 leads and 10 seconds of data for Lead II.

Note: The fiducial marks displayed in the 4-channel format identify the measurement intervals used for the interpretive statements of the analysis program. These marks are part of the analysis program and cannot be turned off.

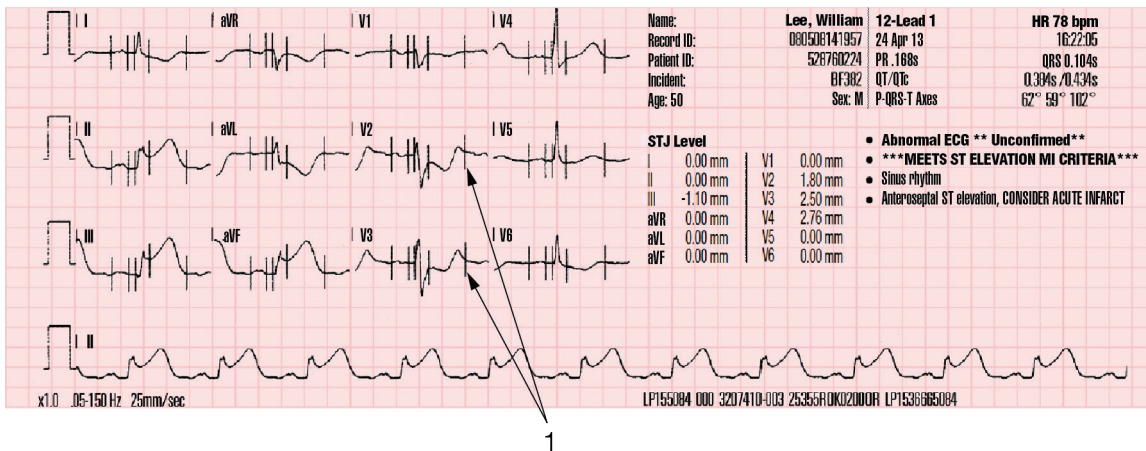

Figure 23 Example of Printed 4-Channel, Standard 12-Lead ECG Report

FIGURE LEGEND

- 1 Fiducial marks

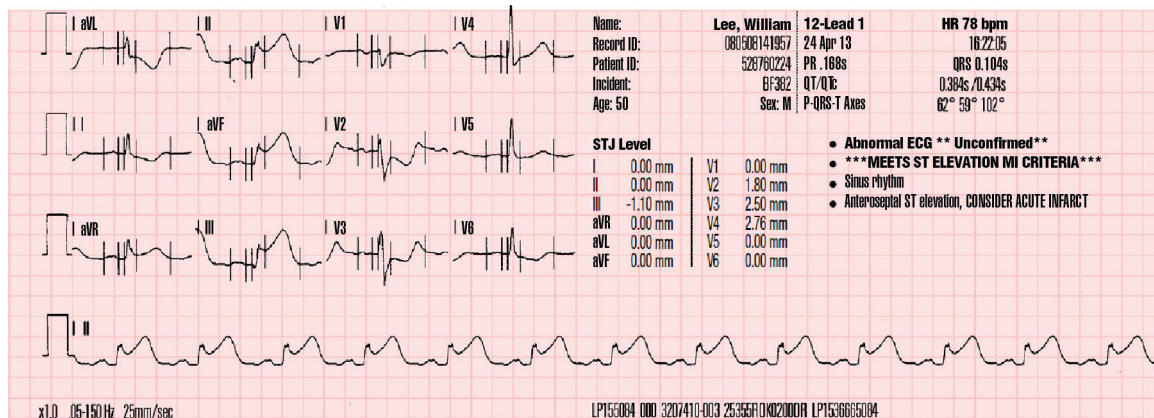

Figure 24 Example of Printed 4-Channel, Cabrera 12-Lead ECG Report

Printed 12-Lead ECG Frequency Response

The 12-lead ECG can be printed in two diagnostic frequency responses (or bandwidths): 0.05–40 Hz and 0.05–150 Hz. The frequency response of 0.05–150 Hz is the Association for the Advancement of Medical Instrumentation (AAMI) standard for diagnostic ECGs. The 0.05–40 Hz setting preserves the low frequency limit that is needed for the diagnosis of myocardial ischemia and infarction while reducing high frequency artifact (in particular from patient muscle tension) to help make the diagnostic printout less noisy and more readable.

Note: The LIFEPAK 15 monitor/defibrillator acquires ECG data and performs the interpretive analysis based on the full frequency of 0.05–150 Hz. The 0.05–40 Hz bandwidth affects only the printed appearance of the ECG data.

The 12-lead ECG printed in the 0.05–40 Hz setting can be used to diagnose acute myocardial ischemia and ST-segment elevation myocardial infarction (STEMI). This is because the low frequency limit of 0.05 Hz is not changed from the standard diagnostic setting of 0.05–150 Hz. The 0.05 Hz frequency provides accurate representation of low frequency signals, that is, the P, ST segment, and T waves. The presence or absence of ST segment changes indicative of myocardial ischemia or infarction will be accurately reproduced. In addition, the criteria for visual analysis and interpretation of cardiac rhythm and PR, QRS, and QT intervals are preserved, as is true with hospital cardiac monitors that have an upper frequency limit of 40 Hz.

However, in some adult patients, the amplitude (that is, voltage) of the QRS may be reduced when 12-lead ECGs are printed at the upper limit of 40 Hz rather than at 150 Hz. Therefore, certain diagnoses, which depend on R wave amplitude (for example, ventricular hypertrophy), should not be made using this setting. In the pediatric patient, this effect on R wave amplitude is particularly noticeable because QRS durations in children are typically quite narrow. Because R wave amplitude reduction is more likely with pediatric patients, the 12-lead ECG automatically prints at 0.05–150 Hz, overriding the 40 Hz limit, when a patient age of 15 years or younger is entered.

Troubleshooting Tips

Table 12 Troubleshooting Tips for the 12-Lead ECG

OBSERVATION	POSSIBLE CAUSE	CORRECTIVE ACTION
Any of these messages displayed: CONNECT ECG LEADS	One or more ECG electrodes disconnected	<ul style="list-style-type: none"> • Confirm ECG electrode connections.
	ECG cable is not connected to monitor	<ul style="list-style-type: none"> • Confirm ECG cable connections.
ECG LEADS OFF XX LEADS OFF	Poor electrode-skin contact	<ul style="list-style-type: none"> • Reposition cable and/or lead wires to prevent electrodes from pulling away from patient. • Secure trunk cable clasp to patient's clothing. • Prepare skin and apply new electrodes.
	Broken lead wire	<ul style="list-style-type: none"> • Select another lead. • Select PADDLES lead, and use standard paddles or therapy electrodes for ECG monitoring. • Check ECG cable continuity.
Noisy signal and/or message displayed: NOISY DATA! PRESS 12-LEAD TO ACCEPT	Noise in a lead other than the displayed lead	<ul style="list-style-type: none"> • Press 12-LEAD again to override the message. Examine the printout to determine leads affected by noise. Replace or reposition the affected electrodes and lead wires.
	Poor electrode-skin contact	<ul style="list-style-type: none"> • Reposition cable and/or lead wires to prevent electrodes from pulling away from patient. • Secure trunk cable clasp to patient's clothing. • Prepare skin and apply new electrodes.
	Loose connection	<ul style="list-style-type: none"> • Check or reconnect cable connections.
	Patient motion	<ul style="list-style-type: none"> • Encourage patient to lie quietly. • Support patient's limbs.
	Vehicle motion	<ul style="list-style-type: none"> • Stop vehicle while acquiring 12-lead ECG data.
	Outdated, corroded, or dried-out electrodes	<ul style="list-style-type: none"> • Check Use By date on electrode packages. • Use only unexpired silver/silver chloride electrodes. Leave electrodes in sealed pouch until time of use.
	Radio Frequency Interference (RFI)	<ul style="list-style-type: none"> • Check for equipment causing RFI (such as a radio transmitter) and relocate or turn off equipment power.
	Damaged cable or connector/lead wire	<ul style="list-style-type: none"> • Inspect main cable and attachments. Replace if damaged.

Acquiring a 12-Lead ECG

OBSERVATION	POSSIBLE CAUSE	CORRECTIVE ACTION
Monitor does not complete 12-lead ECG operation sequence or 12-LEAD STOPPED message appears.	Operator pressed another function button (such as PRINT) before 12-lead ECG sequence completed	<ul style="list-style-type: none"> Press 12-LEAD to acquire another 12-lead ECG. Allow enough time for sequence to complete.
	12-lead button pressed without 5-lead or 12-lead cable connected.	<ul style="list-style-type: none"> Connect 5-lead or 12-lead ECG cable.
Noisy signal and message displayed: EXCESSIVE NOISE-12-LEAD CANCELLED	Signal noise for more than 30 seconds	<ul style="list-style-type: none"> Press 12-LEAD to acquire another 12-lead ECG.
Baseline wander (low frequency/high amplitude artifact)	Inadequate skin preparation	<ul style="list-style-type: none"> Prepare skin as described in ECG Monitoring Procedure (on page 55) and apply new electrodes.
	Poor electrode-skin contact	<ul style="list-style-type: none"> Check electrodes for proper adhesion.
Fine baseline artifact (high frequency/low amplitude)	Inadequate skin preparation	<ul style="list-style-type: none"> Prepare skin as described in ECG Monitoring Procedure (on page 55) and apply new electrodes.
	Isometric muscle tension in arms/legs	<ul style="list-style-type: none"> Confirm that limbs are resting on a supportive surface. Check electrodes for proper adhesion.

For general troubleshooting tips, see General Troubleshooting Tips (on page 220).

Monitoring SpO₂, SpCO, and SpMet

SpO₂, SpCO™, and SpMet™ are optional features for the LIFEPAK 15 monitor/defibrillator. When all three options (SpO₂, SpCO, and SpMet) are installed, the pulse oximeter measures functional oxygen saturation (SpO₂), carboxyhemoglobin concentration (SpCO), and methemoglobin concentration (SpMet) in the blood.

IMPORTANT! SpO₂-only sensors and combination SpO₂, SpCO, and SpMet sensors are available for use. Masimo® SpO₂-only sensors that have a red connector are compatible with the LIFEPAK 15 monitor. Masimo Rainbow® sensors are necessary to monitor SpCO and SpMet in addition to SpO₂. These sensors are not compatible with other LIFEPAK defibrillator/monitors.

Nellcor SpO₂ sensors may be used with the LIFEPAK 15 monitor/defibrillator, if the Masimo Red™ MNC adapter cable is used.

For a list of SpO₂ sensors and connector cables that are intended for use with the LIFEPAK 15 monitor/defibrillator, see the Physio-Control website. Carefully read the Directions for Use that are provided with the sensors and connector cables for a complete description, instructions, warnings, cautions, and specifications. To order sensors and connector cables, contact your Physio-Control representative. In the USA, call Customer Support at 1.800.442.1142, option 2.

Intended Use

A pulse oximeter is a noninvasive device that continuously measures functional oxygen saturations (SpO₂), carboxyhemoglobin concentration (SpCO), and methemoglobin concentration (SpMet) in the blood. Continuously monitoring SpO₂ can provide an early warning when oxygen saturation is decreasing and can help the clinician act rapidly before the patient develops the later signs of hypoxemia. Previously, the blood parameters SpCO and SpMet could only be obtained from invasive blood gas samples. This new technology assists in identifying the often hidden conditions of carboxyhemoglobinemia (carbon monoxide poisoning) and methemoglobinemia (a condition that impedes delivery of oxygen to the tissues). Low levels of both SpCO and SpMet are normally found in the blood; however, early detection of significantly high levels can lead to proper diagnosis and treatment, and can help improve patient outcome.

Pulse oximetry is a tool to be used in addition to patient assessment. Care should be taken to assess the patient at all times; do not rely solely on the SpO₂, SpCO, and SpMet measurements. If a trend toward patient deoxygenation is evident or carbon monoxide poisoning or methemoglobinemia is suspected, blood samples should also be analyzed using laboratory instruments to completely understand the patient's condition.

Do not use the pulse oximeter to monitor patients for apnea, or as a replacement or substitute for ECG-based arrhythmia analysis.

Indications

Pulse oximetry is indicated for use in any patient who is at risk of developing hypoxemia, carboxyhemoglobinemia, or methemoglobinemia. SpO₂ monitoring may be used during no motion and motion conditions, and in patients who are well or poorly perfused. SpCO and SpMet accuracies have not been validated under motion or low perfusion conditions.

Contraindications

None known.

SpO₂, SpCO, and SpMet Warnings and Cautions

WARNING

Shock or Burn Hazard

Before use, carefully read these operating instructions, the sensor and cable directions for use, and precautionary information.

WARNING

Shock or Burn Hazard

Using other manufacturers' sensors or cables may cause improper oximeter performance and invalidate safety agency certifications. Use only sensors and cables that are specified in these operating instructions.

WARNING

Inaccurate Pulse Oximeter Readings

Do not use a damaged sensor or cable. Do not alter the sensor or cable in any way. Alterations or modification may affect performance and/or accuracy. Never use more than one cable between the pulse oximeter and the sensor to extend the length.

WARNING

Inaccurate Pulse Oximeter Readings

Sensors exposed to ambient light when incorrectly applied to a patient may exhibit inaccurate saturation readings. Securely place the sensor on the patient and check the sensor's application frequently to help ensure accurate readings.

WARNING

Inaccurate Pulse Oximeter Readings

Severe anemia, hypothermia, severe vasoconstriction, carboxyhemoglobin, methemoglobin, intravascular dyes that change usual blood pigmentation, elevated bilirubin, excessive patient movement, venous pulsations, electrosurgical interference, exposure to irradiation and placement of the sensor on an extremity that has a blood pressure cuff, intravascular line, or externally applied coloring (such as nail polish) may interfere with oximeter performance. The operator should be thoroughly familiar with the operation of the oximeter prior to use.

WARNING

Inaccurate Pulse Oximeter Readings

The pulsations from intra-aortic balloon support can be additive to the pulse rate on the oximeter pulse rate display. Verify patient's pulse rate against the ECG heart rate.

WARNING

Possible Skin Injury

Prolonged, continuous use of a sensor may cause irritation, blistering, or pressure necrosis of the skin. Check the sensor site regularly based on patient condition and type of sensor. Change the sensor site if skin changes occur. Do not use tape to hold the sensor in place as this may cause inaccurate readings or damage to the sensor or skin.

WARNING

Possible Strangulation

Carefully route patient cabling to reduce the possibility of patient entanglement or strangulation.

CAUTION

Possible Equipment Damage

To avoid damage to the cable, always hold by the connector rather than the cable, when connecting or disconnecting either end.

CAUTION

Possible Equipment Damage

Do not soak or immerse the sensors or cables in any liquid solution. Do not attempt to sterilize.

No Implied License

Possession or purchase of the pulse oximeter does not convey any expressed or implied license to use the pulse oximeter with unauthorized sensors or cables which would, alone or in combination with this device, fall within the scope of one or more of the patents relating to this device.

How a Pulse Oximeter Works

A pulse oximeter sensor directs light through a patient's fleshy body site (usually a finger or toe). The sensor sends wavelengths of light from the emitter to the receiving detector as shown in the following figure.

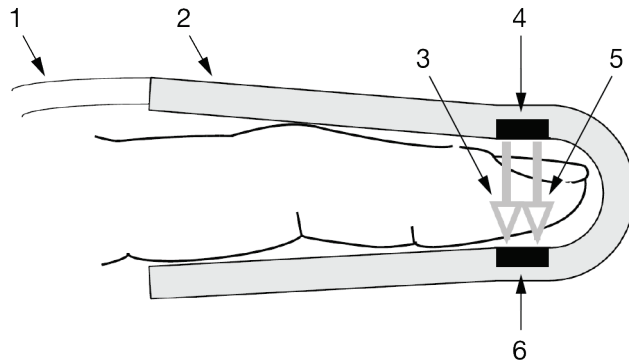

Figure 25 How a Pulse Oximeter Works

FIGURE LEGEND

1	Cable	4	Light-emitting diodes
2	Sensor (holds LEDs and detector)	5	Infrared
3	Red	6	Light-receiving detector

The pulse oximeter translates the amount of light received by the detector to the various forms of hemoglobin saturation levels and displays them as SpO₂, SpCO, and SpMet percentages. Normal values for SpO₂ typically range from 95% to 100%. Normal values for SpCO are typically less than 9% (the higher range of normal is often seen in smokers). Normal values for SpMet are typically less than 2% and may be caused by exposure to some pharmaceuticals including local anesthetic agents and chemical agents such as nitrites.

SpO₂, SpCO, and SpMet Monitoring Considerations

The quality of the SpO₂, SpCO, and SpMet readings depends on correct sensor size and placement, adequate blood flow through the sensor site, and limiting patient motion and sensor exposure to ambient light. For example, with very low perfusion at the sensor site, readings may be lower than core arterial oxygen saturation. Test methods for accuracy are available by contacting your local Physio-Control representative.

Use the following criteria to select the appropriate pulse oximeter sensor:

- Patient size (adult, pediatric, infant) and weight
- Patient perfusion to extremities
- Patient activity level
- Available application sites on the patient's body
- Sterility requirements
- Anticipated duration of monitoring

To help ensure optimal performance:

- Use a dry and appropriately sized sensor.
- Choose a site that is well perfused. The ring finger is preferred.
- Choose a site that least restricts patient movement, such as finger of the non-dominant hand.
- Be sure the fleshy part of the digit completely covers the detector.
- Keep the sensor site at the same level as the patient's heart.
- Apply the sensor according to the Directions for Use provided with the sensor.
- Observe all warnings and cautions noted in the sensor's Directions for Use.

Sensor Application

The preferred site for sensor application is the ring finger of the non-dominant hand. To position the sensor:

1. Orient the sensor so the cable is on the back of the patient's hand.
2. Place the finger in the sensor until the tip of the finger touches the "raised digit stop."
3. The hinged tabs of the sensor should open to evenly distribute the grip pressure of the sensor along the length of the finger. Check the arrangement of the sensor to verify correct positioning. Complete coverage of the detector window is needed to ensure accurate data.

The sensors are sensitive to light. If excessive ambient light is present, remove or reduce lighting, cover the sensor site with an opaque material to block the light, and check appropriateness of sensor site. Failure to do so could result in inaccurate measurements.

If excessive movement presents a problem during SpCO/SpMet monitoring, consider the following possible solutions:

- Be sure the sensor is secure and properly aligned.
- Use a disposable adhesive sensor.
- If possible, move the sensor to a less active site.

Note: Wrapping the sensor too tightly or using supplemental tape to hold the sensor in place may cause inaccurate oximeter readings.

Note: Circulation distal to the sensor site should be checked routinely.

IMPORTANT! Masimo Rainbow sensors are necessary to monitor SpCO and SpMet and are not compatible with other LIFEPAK defibrillator/monitors.

Oximeter Monitoring Procedure

Power to the pulse oximeter is controlled by the LIFEPAK 15 monitor/defibrillator. When the defibrillator is turned on, the oximeter turns on and performs a calibration and self-test that requires approximately 20 seconds. During the calibration and self-test, the screen does not display SpO₂, SpCO, or SpMet information.

To conserve battery power, the pulse oximeter goes into "sleep mode" when not in use. Sleep mode is activated within 10 seconds of disconnecting the sensor. During sleep mode, the screen does not display SpO₂, SpCO, or SpMet information. When a sensor or patient signal is detected, the oximeter performs a self-test and then returns to normal mode.

The pulse oximeter measures and displays SpO₂ levels between 50 and 100%. SpO₂ levels less than 50% are displayed as <50. The pulse oximeter measures and displays SpCO in the range of 0–40%. The pulse oximeter measures and displays SpMet in the range of 0–15%. Measurement accuracies are specified in the SpO₂/SpCO/SpMet section in Appendix A.

To monitor SpO₂:

1. Press **ON**.
2. Connect the pulse oximeter cable to the monitor and sensor.
3. Attach the sensor to the patient.
4. Observe the pulse bar for fluctuation. Amplitude of the pulse bar indicates relative signal quality.
5. Confirm that the SpO₂ reading appears and is stable.
6. Use the **SPEED DIAL** to adjust volume, sensitivity, and averaging time, as necessary.

To monitor SpCO or SpMet:

1. Perform Step 2 through Step 5 above.
2. Verify that an SpCO/SpMet sensor is in use. Only Rainbow sensors are capable of reading SpCO/SpMet.
3. Encourage the patient to remain still.
4. To quickly obtain SpCO or SpMet value, press **PRINT**. If dashes (---) appear on printout instead of values for SpCO or SpMet, allow a few more seconds for measurement to be obtained.

or

To display SpCO or SpMet:

- Use the **SPEED DIAL** to select the SpO₂ area.
- Select **PARAMETER** from menu.
- Select **SPCO** or **SPMET**. Selected value displays for 10 seconds.

Note: SpCO and SpMet monitoring are not intended for use under patient motion or low perfusion conditions.

SpCO/SpMet Advisory

If the SpCO or SpMet reading is above normal limits, indicating a dangerous amount of carboxyhemoglobin or methemoglobin, an Advisory occurs.

During an Advisory:

- The elevated SpCO or SpMet value is displayed instead of SpO₂.
- The elevated value flashes and the alarm tone sounds.
- One of the following Advisory messages appears in the message area:

Advisory: SpCO > 10%

Advisory: SpMet > 3%

To cancel the Advisory, press **ALARMS**. The SpO₂ area reverts to the SpO₂ reading. The Advisory message remains on the screen until the elevated value returns to within normal limits or the device is turned off.

WARNING

Inaccurate SpO₂ Readings

Carboxyhemoglobin and methemoglobin may erroneously increase SpO₂ readings. The amount that SpO₂ increases is approximately equal to the amount of carboxyhemoglobin or methemoglobin that is present.

WARNING

Inaccurate SpCO and SpMet Readings

Very low arterial oxygen saturation levels may cause inaccurate SpCO and SpMet readings.

Pleth Waveform

You can display the plethysmographic (pleth) waveform in Channel 2 or 3.

To display the pleth waveform:

1. Rotate the **SPEED DIAL** to outline waveform **Channel 2** or **3**.
2. Press the **SPEED DIAL**. The Channel menu appears.
3. Select **WAVEFORM** and then select **SPO₂**. The SpO₂ waveform appears in the selected channel. The waveform is automatically sized for optimum waveform viewing.

Volume

To adjust the pulse tone volume:

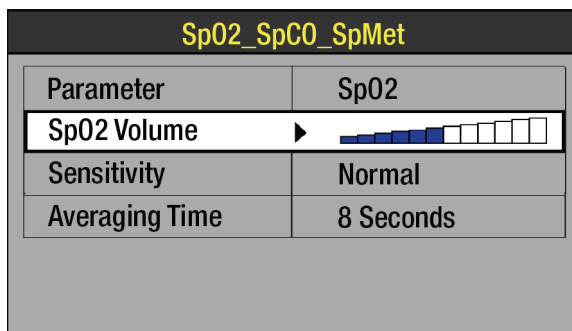

1. Rotate the **SPEED DIAL** to outline the SpO₂ area on the Home Screen.
2. Press the **SPEED DIAL**.
3. Highlight and select **SPO₂ VOLUME**.
4. Rotate the **SPEED DIAL** to the desired volume.
5. Press the **SPEED DIAL** to set the volume.

Sensitivity

The sensitivity setting allows you to adjust the oximeter to either **NORMAL** or **HIGH** for differing perfusion states.

To adjust sensitivity:

1. Outline and select the SpO₂ area on the Home Screen.
2. Select **SENSITIVITY** and then select **NORMAL** or **HIGH**.

Note: **NORMAL** sensitivity is recommended for most patients. The **HIGH** sensitivity setting allows SpO₂ monitoring under low perfusion states, such as the severe hypotension of shock. However, when SpO₂ sensitivity is set to **HIGH**, the signal is more susceptible to artifact. Monitor the patient closely when using the **HIGH** sensitivity setting.

Averaging Time

Averaging time allows you to adjust the time period that is used to average the SpO₂ value.

To adjust averaging time:

1. Outline and select the SpO₂ area on the Home Screen.
2. Select **AVERAGING TIME** and then select one of the following:
 - 4 Seconds
 - 8 Seconds
 - 12 Seconds
 - 16 Seconds

Note: Averaging time of 8 seconds is recommended for most patients. For patients with rapidly changing SpO₂ values, 4 seconds is recommended. Use a 12- or 16-second time period when artifact is affecting the performance of the pulse oximeter.

Pulse Rate Monitoring

If ECG monitoring is not active, the SpO₂ sensor can be used to monitor the patient's pulse rate. The pulse rate value is indicated by **PR (SPO2)**.

Pulse rate monitoring is a tool to be used in addition to patient assessment. Care should be taken to assess the patient at all times. Check pulse manually if patient shows signs of abnormal pulse rate.

Note: This function may not work if ECG leads are attached to a patient.

Cleaning

Pulse oximetry sensors may be adhesive (single-patient use) or reusable.

To clean the reusable sensor and connector cable:

1. Disconnect the sensor and cable from the monitor. Inspect the cable for damage.
2. Use a clean, soft cloth dampened with 70% isopropyl alcohol to wipe clean.
3. Allow to dry thoroughly before placing the sensor on a patient or reconnecting the cable to the monitor.

Note: Do not attempt to sterilize. Do not soak or immerse in any liquid solution. For information about cleaning the device, see *Cleaning the Device* (on page 218).

Troubleshooting Tips

Table 13 Troubleshooting Tips for SpO₂, SpCO, and SpMet

OBSERVATION	POSSIBLE CAUSE	CORRECTIVE ACTION
The monitor measures a pulse, but there is no oxygen saturation or pulse rate	Excessive patient motion	<ul style="list-style-type: none"> • Keep patient still. • Check that sensor is secure. • Relocate sensor. • Apply adhesive sensor.
	Patient perfusion may be too low	<ul style="list-style-type: none"> • Check patient. • Increase sensitivity.
SpO ₂ or pulse rate changes rapidly, pulse amplitude is erratic	Excessive patient motion	<ul style="list-style-type: none"> • Keep patient still. • Check that sensor is secure. • Relocate sensor. • Apply adhesive sensor. • Increase sensitivity.
	An electrosurgical unit (ESU) may be interfering with performance	<ul style="list-style-type: none"> • Move the monitor as far as possible from the ESU. • Plug the ESU and monitor into different circuits. • Move the ESU ground pad as close to the surgical site as possible.
	Sensor may be damp	<ul style="list-style-type: none"> • Replace sensor.
SPO₂: NO SENSOR DETECTED message appears	Sensor not connected to patient or cable disconnected from monitor/defibrillator	<ul style="list-style-type: none"> • Check that sensor and cable are connected properly. • Check that appropriate sensor is in use.
	Damaged cable or sensor	<ul style="list-style-type: none"> • Replace damaged cable or sensor.

OBSERVATION	POSSIBLE CAUSE	CORRECTIVE ACTION
No SpO ₂ , SpCO, or SpMet value (---) is displayed	Sensor may be too tight	<ul style="list-style-type: none"> • Reposition sensor. • Relocate sensor.
	Patient is in cardiac arrest or shock	<ul style="list-style-type: none"> • Check patient.
	Oximeter may be performing self-calibration or self-test	<ul style="list-style-type: none"> • Wait for completion. • If values do not display within 30 seconds, disconnect and reconnect sensor. If values do not display within another 30 seconds, replace sensor.
	Defibrillator shock just delivered	<ul style="list-style-type: none"> • None. If values do not display within 30 seconds, disconnect and reconnect sensor. If values do not display within another 30 seconds, replace sensor.
	High intensity lights (such as pulsating strobe lights) may be interfering with performance	<ul style="list-style-type: none"> • Cover sensor with opaque material, if necessary.
Different SpCO or SpMet measurements on same patient	Damaged cable or sensor	<ul style="list-style-type: none"> • Replace damaged cable or sensor.
	Every measurement, even on the same patient, can be different	<ul style="list-style-type: none"> • Confirm by taking three measurements: ring finger, middle finger, and then index finger; average the results.
XXX appears in place of SpO ₂ reading	SpO ₂ module failed. Internal cable failed.	<ul style="list-style-type: none"> • Turn device off and then on again. • If problem persists, contact qualified service personnel.
SPO2: CHECK SENSOR message appears	Sensor is disconnected from patient or cable	<ul style="list-style-type: none"> • Attach the sensor. • Check that sensor is secure.
	Excessive ambient light	<ul style="list-style-type: none"> • Remove or block light source, if possible. • Cover sensor with opaque material, if necessary.
	Faulty or defective sensor	<ul style="list-style-type: none"> • Replace sensor.
	Patient has a weak pulse or low blood pressure, or the sensor is not properly placed	<ul style="list-style-type: none"> • Change sensor location. • Check if patient perfusion is adequate for sensor location. • Check that sensor is secure and not too tight. • Check that sensor is not on extremity with blood pressure cuff or intravascular line. • Test sensor on someone else.

Monitoring SpO₂, SpCO, and SpMet

OBSERVATION	POSSIBLE CAUSE	CORRECTIVE ACTION
SPO₂: UNKNOWN SENSOR message appears	A sensor that is not Physio-Control approved is connected to the device	<ul style="list-style-type: none"> • Check that the sensor is approved by Physio-Control. • If using Nellcor sensor, check that it is connected to monitor using Masimo Red MNC adapter cable.
SPO₂: SEARCHING FOR PULSE message appears	A sensor is connected to the patient and is searching for a pulse	<ul style="list-style-type: none"> • Wait for completion.
SPO₂: LOW PERFUSION message appears	Patient has a weak pulse	<ul style="list-style-type: none"> • Change sensor location.
SPO₂: POOR QUALITY SIGNAL message appears	When the signal quality is low, the accuracy of the measurement may be compromised	<ul style="list-style-type: none"> • Check that sensor and cable are connected properly. • Move sensor to a better perfused site.
SPCO: POOR QUALITY SIGNAL message appears	When the signal quality is low, the accuracy of the measurement may be compromised	<ul style="list-style-type: none"> • Check that sensor and cable are connected properly. • Move sensor to a better perfused site.
SPMET: POOR QUALITY SIGNAL message appears	When the signal quality is low, the accuracy of the measurement may be compromised	<ul style="list-style-type: none"> • Check that sensor and cable are connected properly. • Move sensor to a better perfused site.
SPCO/SPMET: POOR QUALITY SIGNAL message appears	When the signal quality is low, the accuracy of the measurement may be compromised	<ul style="list-style-type: none"> • Check that sensor and cable are connected properly. • Move sensor to a better perfused site.
SPO₂: SENSOR DOES NOT SUPPORT SPCO OR SPMET message appears	SpO ₂ -only sensor used with SpCO/SpMet capable device	<ul style="list-style-type: none"> • None necessary, or use Rainbow sensor to measure SpCO or SpMet.

Note: Most Rainbow sensor messages (SpO₂, SpCO, and SpMet) are reported as **SPO₂: (MESSAGE)**. The **POOR QUALITY SIGNAL** message indicates the specific parameter affected.

For general troubleshooting tips, see General Troubleshooting Tips (on page 220).

Monitoring Noninvasive Blood Pressure

Intended Use

The LIFEPAK 15 noninvasive blood pressure (NIBP) monitor measures blood pressure (BP) using the oscillometric measurement technique to determine systolic, diastolic, and mean arterial pressures, and pulse rate. The measurement can be initiated manually or set to recur automatically at predetermined intervals.

Blood pressure measurements determined using this device are equivalent to those obtained by a trained observer using the cuff/stethoscope auscultation method, within the limits prescribed by the American National Standard *Electronic or automated sphygmomanometers* (AAMI SP-10).

NIBP is a tool to be used in addition to patient assessment. Care should be taken to assess the patient at all times; do not rely solely on the NIBP monitor.

Indications

Noninvasive blood pressure monitoring is intended for detection of hypertension or hypotension and monitoring BP trends in patient conditions such as, but not limited to, shock, acute dysrhythmia, or major fluid imbalance. NIBP monitoring is not indicated for neonatal patients less than one month old.

Contraindications

None known.

NIBP Monitoring Warnings and Caution

WARNING

Possible Loss of Intravenous Access and Inaccurate Infusion Rate

Do not apply the blood pressure cuff on an extremity that is used for an intravenous infusion or arteriovenous (A-V) shunt. Patency of the intravenous infusion may be affected by blood pressure measurement due to the occlusion of blood flow.

WARNING

Possible Circulation Impairment

Blood flow to the extremity may be impaired by prolonged, continuous use of a blood pressure cuff, a kink in the tubing, or frequent measurements. Check circulation regularly and loosen or reposition the cuff if changes in circulation occur.

WARNING

Possible Inaccurate Blood Pressure Readings

Do not alter the NIBP monitor's pneumatic tubing. Altering NIBP tubing may cause improper performance and may void the warranty. Avoid compression or restriction of pressure tubes.

WARNING

Possible Patient Harm

Do not apply the blood pressure cuff over a wound. Doing so may cause further injury.

WARNING

Possible Patient Harm

Do not apply the blood pressure cuff on the arm on the side of a mastectomy.

WARNING

Possible Inaccurate Blood Pressure Readings

Using NIBP accessories not recommended by Physio-Control may cause the device to perform improperly and invalidate the safety agency certifications. Use only the accessories that are specified in these operating instructions.

WARNING

Possible Inaccurate Oxygen Saturation Readings

Do not perform NIBP measurement on an extremity used for oxygen saturation monitoring. Oxygen saturation measurement is affected by blood pressure measurement due to the occlusion of blood flow.

CAUTION

Equipment Damage

Do not inflate a cuff unless it is placed on an extremity.

How NIBP Monitoring Works

The NIBP monitor uses the oscillometric measurement technique. The oscillometric technique does not use Korotkoff sounds to determine blood pressure; rather, it monitors the changes in pressure pulses that are caused by the flow of blood through the artery. The NIBP monitor inflates the cuff around the patient's arm to a value that occludes the artery, and then deflates the cuff in steps. When blood starts to flow through the artery, the increasing blood flow causes the amplitude of the pressure pulses in the cuff to increase. As the NIBP monitor steps the pressure down, the pulses reach a peak amplitude and then start to decrease. The rising and falling amplitude values form a curve that is analyzed to yield systolic pressure, diastolic pressure, and mean arterial pressure (MAP).

The NIBP monitor measures the pulse rate by tracking the number of pulses over time. The NIBP monitor uses artifact rejection techniques to provide accurate results under most operating conditions. When a patient is experiencing arrhythmias during a measurement, the accuracy of the pulse determination may be affected or the time needed to complete a measurement may be extended. In shock conditions, the low amplitude of blood pressure waveforms makes it difficult for the monitor to accurately determine the systolic and diastolic pressures.

NIBP Monitoring Considerations

As with any noninvasive oscillometric blood pressure monitor, clinical conditions can affect the accuracy of the measurements obtained, including the following:

- The patient's physiological condition. For example, shock may result in a blood pressure waveform that has a low amplitude, making it difficult for the monitor to accurately determine the systolic and diastolic pressures. Altered hemodynamics caused by pregnancy, including preeclampsia, may result in inaccurate readings.
- The position of the patient.
- Motion may prolong the measurement process since motion artifacts have to be rejected in the data stream. Motion that affects measurement can include patient movement, patient seizure, bumping the cuff, and flexing the extremity under the cuff.
- The presence of other medical devices. The NIBP monitor does not operate effectively if the patient is connected to a heart/lung machine.
- Extremes of temperature, humidity, or altitude.
- When a patient is experiencing arrhythmias, pulse rate accuracy may be affected or the time needed to complete an NIBP measurement may be extended. The device automatically deflates if a blood pressure measurement cannot be obtained in 120 seconds.
- Blood pressure and pulse can fluctuate greatly between measurements; the monitor cannot alert the operator of changes in vital signs that occur between measurement cycles.
- There may be some difference between readings taken manually and readings from the NIBP monitor due to the differing sensitivity of the two methods. The NIBP monitor meets the ANSI/SP10 AAMI standard that requires a mean difference of ± 5 mmHg, with a standard deviation no greater than 8 mmHg, compared to auscultatory readings.

- When using the NIBP monitor during defibrillation, the NIBP monitor is not available when the defibrillator is being charged. Upon shock, the monitor resets and dashes (– –) appear in place of pressure readings. After defibrillation, you can resume blood pressure measurement according to NIBP Monitoring Procedure (on page 86).
- If the blood pressure cuff fails to deflate for any reason or causes undue discomfort to the patient, remove the cuff from the arm or disconnect the tubing from the defibrillator.
- If the patient has been active, optimal resting measurements will be obtained if you wait five minutes before taking a blood pressure measurement.

Cuff Selection

The use of properly designed and sized cuffs is essential for the accurate measurement of blood pressure. The cuff must fit snugly around the extremity to occlude the artery. For a list of BP cuffs that are intended for use with the LIFEPAK 15 monitor/defibrillator, see the LIFEPAK 15 Monitor/Defibrillator Accessories Catalog at www.physio-control.com.

NIBP Monitoring Procedure

The NIBP monitor inflates an occluding cuff and determines systolic and diastolic pressures, mean arterial pressure (MAP), and pulse rate. Pressure measurements are reported in mmHg and pulse rate in beats per minute (bpm).

Note: Pulse rate monitoring may not work if ECG leads are attached to the patient.

Both single-measurement and specified-interval (timer-controlled) methods of blood pressure reading are available.

The NIBP monitor draws power from the defibrillator. When the defibrillator is turned on, the NIBP monitor conducts a self-test that takes approximately three seconds.

IMPORTANT! The LIFEPAK 15 monitor NIBP port and tubing are not compatible or interchangeable with the NIBP tubing that is used with other LIFEPAK monitor/defibrillators.

Changing the Initial Inflation Pressure

The initial cuff pressure should be set approximately 30 mmHg higher than the patient's anticipated systolic pressure. The factory default initial inflation pressure for the first measurement is 160 mmHg. For pediatric patients, the initial cuff pressure may need to be lowered. Initial inflation settings are 80, 100, 120, 140, 160, or 180 mmHg. For infants, the recommended initial cuff pressure is 120 mmHg.

Caution should be taken not to lower the initial pressure below the adult patient's systolic measurement. Doing so may cause the cuff to reinflate and cause patient discomfort. For subsequent measurements, the monitor inflates approximately 30 mmHg higher than the previously determined systolic pressure.

To select an initial pressure:

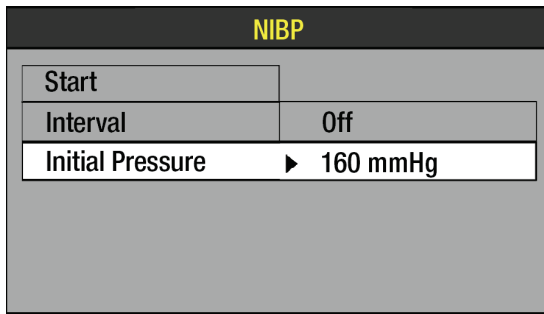

1. Rotate the **SPEED DIAL** to outline the NIBP area.
2. Press the **SPEED DIAL**. The NIBP menu appears.
3. Select **INITIAL PRESSURE**.
4. Rotate the **SPEED DIAL** to the desired pressure.
5. Press the **SPEED DIAL** to set the initial pressure.

Note: Measurement data is recorded in the LIFEPAK 15 monitor/defibrillator Vital Sign Log. For more information about the Vital Sign Log and its use, see Data Management (on page 165).

Manual Single-Measurement Procedure

The NIBP measurement typically takes 40 seconds to complete. If the measurement is not completed within 120 seconds, the cuff automatically deflates.

To obtain a manual single measurement:

1. Press **ON**.
2. Select the appropriately-sized cuff.
3. Properly align the cuff artery markings, if present, and apply snugly to the extremity.
4. Connect the tubing to the cuff and to the NIBP port on the monitor.
5. Change the initial inflation pressure, if necessary.
6. If possible, ensure the patient is comfortably seated with feet flat on the floor, legs uncrossed, and back supported. Ask the patient to relax as much as possible and refrain from talking during the measurement procedure. The operator should be able to view the device screen during the measurement.
7. Position the extremity in a relaxed and supported position at approximately the same level as the right atrium of the patient's heart. Inform the patient that the cuff will inflate and cause a "big squeeze" around the arm and that the patient's fingers may tingle.
8. Press **NIBP** to start the measurement, and check that the patient's arm is not moving. When the measurement is complete, systolic, diastolic, and mean arterial pressures are displayed.

To cancel a measurement, press **NIBP** again.

Note: NIBP pulse rate is displayed only when ECG or SpO₂ is not active.

Timer-Controlled Measurement Procedure

When the timer is set, the monitor performs recurring measurements at a fixed interval. When using timer-controlled measurement, the interval is counted from the start of the measurement to the start of the next measurement. Choices are **OFF** (factory default), **2, 3, 5, 10, 15, 30,** and **60** minutes.

To take a manual measurement between timer-controlled measurements, press **NIBP**. The next interval is counted from the beginning of the manual measurement.



Figure 26 NIBP Measurements and Timer

FIGURE LEGEND

- 1 Countdown timer—displays time until next measurement
- 2 Mean arterial pressure (MAP)
- 3 Systolic pressure
- 4 Diastolic pressure

To set timer-controlled measurements:

1. Press **ON**.
2. Select the appropriately-sized cuff.
3. Properly align the cuff artery markings, if present, and apply snugly to the extremity.
4. Connect the tubing to the cuff and to the NIBP port on the monitor.
5. Rotate the **SPEED DIAL** to outline the NIBP area.
6. Press the **SPEED DIAL**. The NIBP menu appears.
7. Select **INTERVAL** and then select the desired time interval.
8. Position the extremity in a relaxed and supported position at approximately the same level as the right atrium of the patient's heart. Inform the patient that the cuff will inflate and cause a "big squeeze" around the arm and that the patient's fingers may tingle.
9. Press **NIBP** to start the measurement, and check that the patient's arm is not moving. When the measurement is complete, systolic, diastolic, and mean arterial pressures are displayed. The countdown timer shows the time to the next automatic NIBP measurement.

To cancel a measurement in progress, press **NIBP** again.

Note: If at any time the cuff pressure exceeds 290 mmHg or there is a system failure of the NIBP module, timer-controlled NIBP is terminated. To reactivate, follow the Timer-Controlled Measurement Procedure.

Cleaning

To clean the cuff and pneumatic tubing:

1. Disconnect the tubing from the cuff and monitor. Use a clean, soft cloth dampened with a germicidal solution to wipe clean.
2. Inspect the tubing for cracks or kinks. If any damage is noted, replace the tubing.
3. Inspect the cuff for damage or excessive wear. If any damage is noted, replace the cuff.
4. Allow both to dry before placing the cuff on a patient or reconnecting the tubing to the monitor.

For information about cleaning the device, see *Cleaning the Device* (on page 218).

Troubleshooting Tips

Table 14 Troubleshooting Tips for NIBP Monitoring

OBSERVATION	POSSIBLE CAUSE	CORRECTIVE ACTION
NIBP AIR LEAK message appears	Cuff applied too loosely Leak in cuff/monitor pneumatic system	<ul style="list-style-type: none"> • Check cuff for snug fit on patient. • Check that the cuff/monitor connection is secure. • Check cuff for leaks. Do not use a cuff that exhibits a leak.
NIBP FLOW ERROR message appears	The pneumatic system is not maintaining stable cuff pressure	<ul style="list-style-type: none"> • Deflate or remove cuff. • Check tubing for leaks. • Replace cuff.
NIBP FAILED message appears	The monitor cannot establish zero-pressure reference	<ul style="list-style-type: none"> • Check tubing for kink or blockage. • If this message persists, remove monitor from use and obtain service. Use another method to measure the patient's blood pressure.
NIBP INITIALIZING message appears	NIBP requested while NIBP module is still initializing	<ul style="list-style-type: none"> • Wait until message disappears and request NIBP.
NIBP MOTION message appears	The patient extremity moved too much for the monitor to accurately complete the measurement	<ul style="list-style-type: none"> • Have patient lie quietly with extremity relaxed and supported. • Check that patient's arm does not move during NIBP measurement.
NIBP OVERPRESSURE message appears	Cuff pressure exceeded 290 mmHg	<ul style="list-style-type: none"> • Disconnect tubing or remove cuff. • Avoid very rapid squeezing of the cuff. • If this message persists, remove the cuff from use and obtain service.

Monitoring Noninvasive Blood Pressure

OBSERVATION	POSSIBLE CAUSE	CORRECTIVE ACTION
NIBP TIME OUT message appears	The monitor did not complete a measurement in 120 seconds	<ul style="list-style-type: none"> • Check cuff for snug fit on patient. • Check that cuff artery markings are aligned with the artery. • Repeat measurement. • Try a higher initial pressure. • If this message persists, use another method to measure the patient's blood pressure.
NIBP WEAK PULSE message appears	The monitor did not detect any pulses	<ul style="list-style-type: none"> • Check pulses distal to the cuff. • Check cuff for snug fit on patient. • Check that cuff artery markings are aligned with the artery.
XXX appears in place of NIBP readings	NIBP module failed. NIBP module failed to calibrate successfully.	<ul style="list-style-type: none"> • Turn device off and then on again. • If problem persists, contact qualified service personnel.
NIBP CHECK CUFF message appears	Cuff is not connected to patient or device	<ul style="list-style-type: none"> • Check cuff for snug fit on patient. • Check that cuff artery markings are aligned with the artery. • Check cuff tubing connection to device.
Unable to connect NIBP tubing to device	The LIFEPAK 12 NIBP tubing connector is not compatible with the LIFEPAK 15 NIBP port	<ul style="list-style-type: none"> • Obtain correct NIBP tubing that is compatible with LIFEPAK 15 monitor/defibrillator.
Cuff not deflating	Internal valves fail to open	<ul style="list-style-type: none"> • Disconnect NIBP tubing. • Remove cuff from patient.
Cuff not inflating	Cuff is not connected to the device	<ul style="list-style-type: none"> • Check tubing connection to device and cuff.
	Leak in tubing, cuff, or connector	<ul style="list-style-type: none"> • Replace NIBP tubing or cuff.

For general troubleshooting tips, see General Troubleshooting Tips (on page 220).

Monitoring ETCO₂

Intended Use

The end-tidal CO₂ (EtCO₂) monitor is a capnometric device that uses non-dispersive infrared spectroscopy to continuously measure the amount of CO₂ during each breath and report the amount present at the end of exhalation (EtCO₂). The sample is obtained by the side stream method and can be used with intubated or nonintubated patients. Respiration rate is also measured and displayed in breaths per minute.

The EtCO₂ monitor is a tool to be used in addition to patient assessment. Care should be taken to assess the patient at all times; do not rely solely on the EtCO₂ monitor.

Indications

EtCO₂ monitoring is used to detect trends in the level of expired CO₂. It is used for monitoring breathing efficacy and treatment effectiveness in acute cardiopulmonary care, for example, to determine if adequate compressions are being performed during CPR or to rapidly detect whether an endotracheal tube has been placed successfully.

Contraindications

None known.

EtCO₂ Monitoring Warnings

WARNING

Fire Hazard

Before use, carefully read these operating instructions, the FilterLine® tubing directions for use, and precautionary information.

WARNING

Fire Hazard

The FilterLine tubing may ignite in the presence of O₂ when directly exposed to laser, electrosurgical devices, or high heat. Use with caution to prevent flammability of the FilterLine tubing.

WARNING

Fire Hazard

Anesthetics become mixed with the patient's air that is sampled by the capnometer. When using the EtCO₂ monitor in the presence of flammable anesthetic mixture with oxygen or nitrous oxide, connect the EtCO₂ gas port to a scavenger system.

WARNING

Possible Inaccurate Patient Assessment

Do not use the EtCO₂ monitor for diagnostic purposes. The EtCO₂ monitor is intended only as an adjunct in patient assessment and is not to be used as a diagnostic apnea monitor. Do not solely rely on respiratory monitoring for detecting cessation of breathing. Follow hospital guidelines and best clinical practices, including monitoring additional parameters that indicate the patient's oxygenation status.

WARNING

Possible Inaccurate CO₂ Readings

Using other manufacturers' CO₂ accessories may cause the device to perform improperly and invalidate the safety agency certifications. Use only the accessories that are specified in these operating instructions.

WARNING

Possible Strangulation

Carefully route the patient tubing (FilterLine) to reduce the possibility of patient entanglement or strangulation.

WARNING

Infection Hazard

Do not reuse, sterilize, or clean Microstream® CO₂ accessories as they are designed for single-patient one-time use.

WARNING

Infection Hazard

Do not return air from the CO₂ exhaust port to the breathing system.

How Capnography Works

An EtCO₂ sensor continuously monitors carbon dioxide (CO₂) that is inspired and exhaled by the patient. The sensor employs Microstream non-dispersive infrared (IR) spectroscopy to measure the concentration of CO₂ molecules that absorb infrared light.

The CO₂ FilterLine system delivers a sample of the exhaled gases directly from the patient into the LIFEPAK 15 monitor for CO₂ measurement. The low sampling flow rate (50 ml/min) reduces liquid and secretion accumulation and prevents obstruction, which maintains the shape of the CO₂ waveform.

The CO₂ sensor captures a micro sample (15 microliters). This extremely small volume allows for fast rise time and accurate CO₂ readings, even at high respiration rates.

The Microbeam IR source illuminates the sample cell and the reference cell. This proprietary IR light source generates only the specific wavelengths characteristic of the CO₂ absorption spectrum. Therefore, no compensations are required when concentrations of O₂, anesthetic agent, or water vapor are present in the exhaled breath.

You can set up the LIFEPAK 15 monitor/defibrillator to use the capnography Body Temperature Pressure Saturated (BTPS) conversion method. This option corrects for the difference in temperature and moisture between the sampling site and alveoli. The correction formula is $0.97 \times$ the measured EtCO₂ value. See the *LIFEPAK 15 Monitor/Defibrillator Setup Options* provided with your device.

EtCO₂ Monitoring Waveform Analysis

Valuable information concerning the patient's expired CO₂ can be acquired by examination and interpretation of the waveform.

Phases of the Waveform

The following figure is a graphic representation of a normal capnograph waveform. Four phases of the waveform require analysis. The flat I–II baseline segment (Respiratory Baseline) represents continued inhalation of CO₂-free gas. This value normally is zero. The II–III segment (Expiratory Upstroke), a sharp rise, represents exhalation of a mixture of dead space gases and alveolar gases from acini with the shortest transit times. Phase III–IV (Expiratory Plateau) represents the alveolar plateau, characterized by exhalation of mostly alveolar gas. Point IV is the end-tidal (EtCO₂) value that is recorded and displayed by the monitor. Phase IV–V (Inspiratory Downstroke), a sharp fall, reflects the inhalation of gases that are CO₂-free. Alterations of the normal capnograph or EtCO₂ values are the result of changes in metabolism, circulation, ventilation, or equipment function.

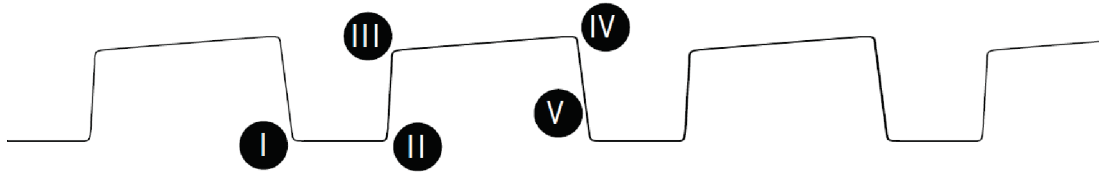

Figure 27 Phases of the Respiratory Waveform

Respiratory Baseline Elevation of the waveform baseline (I–II segment) usually represents rebreathing CO₂. This elevation usually is accompanied by gradual increases in the EtCO₂ value. Rebreathing CO₂ is common in circumstances of artificially produced increased dead space and hypoventilation. Precipitous rises in both baseline and EtCO₂ values usually indicate contamination of the sensor.

Expiratory Upstroke In the normal waveform, the rising phase (II–III segment) is usually steep. When this segment becomes less steep, CO₂ delivery is delayed from the lungs to the sampling site. The causes of this delay can be physiologic or mechanical and include bronchospasm, obstruction of the upper airway, or obstruction (or kinking) of an endotracheal tube (ETT).

Expiratory Plateau The plateau of the waveform, which represents the remainder of expiration (III–IV segment), should be nearly horizontal. The end of the plateau represents the EtCO₂ value. Upward slanting of the expiratory plateau occurs when there is uneven emptying of the alveoli. Similar to the diminished slope of the Expiratory Upstroke, this pattern can occur in asthma, chronic obstructive pulmonary disease (COPD), partial upper-airway obstruction, or partial mechanical obstruction such as a partially kinked ETT.

Inspiratory Downstroke The fall to baseline (IV-V segment) is a nearly vertical drop. This slope can be prolonged and can blend with the expiratory plateau in cases of leakage in the exhale portion of the breathing circuit. The peak EtCO₂ value (IV) is often not reached. Relying on the numeric end-tidal value without observing the breathing waveform may obscure the presence of a leak.

EtCO₂ Monitoring Procedure

When activated, the EtCO₂ monitor draws power from the defibrillator. The LIFEPAK 15 monitor/defibrillator activates the EtCO₂ monitor when it senses the attachment of the FilterLine set. Initialization, self-test, and warm up of the EtCO₂ monitor is typically less than 30 seconds, but may take up to two-and-one-half minutes.

CAUTION**Possible Equipment Damage**

Failure to replace a broken or missing CO₂ port door may allow water or particulate contamination of the internal CO₂ sensor. This may cause the CO₂ module to malfunction.

To monitor EtCO₂:

1. Press **ON**.
2. Select the appropriate EtCO₂ accessory for the patient.
3. Open the CO₂ port door and insert the FilterLine connector; turn connector clockwise until tight.
4. Verify that the CO₂ area is displayed. The EtCO₂ monitor performs the autozero routine as part of the initialization self-test.
5. Display CO₂ waveform in Channel 2 or 3.
6. Connect the CO₂ FilterLine set to the patient.
7. Confirm that the EtCO₂ value and waveform are displayed. The monitor automatically selects the scale for the best visualization of the waveform. You can change the scale, if desired, as described in the next section.

Note: It is possible for the FilterLine set to become loose at the device connection and still have an EtCO₂ value and CO₂ waveform, but they may be erroneously low. Make sure the FilterLine connection is firmly seated and tight.

Note: The capnography module performs self-maintenance within the first hour of monitoring and once an hour during continuous monitoring. The self-maintenance includes "auto-zeroing." Self-maintenance is also initiated when the surrounding temperature changes 8°C (14.4°F) or more, or the surrounding pressure changes greater than 20 mmHg. The CO₂ module detects this change and attempts to purge the tubing. To clear the **CO₂ FILTERLINE PURGING** or **CO₂ FILTERLINE BLOCKAGE** messages, remove the FilterLine tubing and reconnect it to the monitor.

CO₂ Display

The following scales are available to display the CO₂ waveform. The LIFEPAK 15 monitor/defibrillator automatically selects the scale based on the measured EtCO₂ value. To change the CO₂ scale, outline and select the CO₂ area using the **SPEED DIAL** and then select the desired scale from the scale menu.

- Autoscale (default)
- 0–20 mmHg (0–4 Vol% or kPa)
- 0–50 mmHg (0–7 Vol% or kPa)
- 0–100 mmHg (0–14 Vol% or kPa)

The CO₂ waveform is compressed (displayed at 12.5 mm/sec sweep speed) to provide more data in the 4-second screen. There is a slight delay between when the breath occurs and when it appears on the screen. Printouts are at 25 mm/sec. Continuous print may be changed to 12.5 mm/sec, if desired.

The monitor shows the maximum CO₂ value over the last 20 seconds. If the EtCO₂ values are increasing, the change can be seen with every breath. However, if the values are continually decreasing, it will take up to 20 seconds for a lower numerical value to be displayed. Because of this, the EtCO₂ value may not always match the level of the CO₂ waveform.

CO₂ Alarms

The EtCO₂ monitor provides:

- EtCO₂ high and low alarms controlled by activating **ALARMS** (see Alarms (on page 41))
- FiCO₂ (fractional inspired CO₂) alarm (automatic and not adjustable)
- No breath alarm (automatic and not adjustable)

The no breath alarm occurs when the CO₂ values are below 8 mmHg (1.0% or kPa) for 30 seconds. The message **ALARM NO BREATH** appears in the message area along with the time since the last detected CO₂ value of at least 8 mmHg (1.0% or kPa).

WARNING

Possible Inaccurate Patient Assessment

Do not use the EtCO₂ monitor for diagnostic purposes. The EtCO₂ monitor is intended only as an adjunct in patient assessment and is not to be used as a diagnostic apnea monitor. Do not solely rely on respiratory monitoring for detecting cessation of breathing. Follow hospital guidelines and best clinical practices, including monitoring additional parameters that indicate the patient's oxygenation status.

Note: Some software versions display Alarm Apnea instead of Alarm No Breath. The Alarm Apnea and Alarm No Breath messages are equivalent.

CO₂ Detection

A CO₂ waveform appears when any CO₂ is detected, but CO₂ must be greater than 3.5 mmHg for a numerical value to be displayed. However, the CO₂ module will not recognize a breath until the CO₂ is at least 8 mmHg (1.0% or kPa). Valid breaths must be detected in order for the no breath alarm to function and to count the respiratory rate (RR). The RR represents an average over the last eight breaths.

When CO₂ is not detected in the cardiac arrest situation—for example, the CO₂ waveform is either dashes "---" or a flat solid line at or near zero—several factors must be quickly evaluated. Assess for the following causes:

Equipment issues

- Disconnection of the FilterLine set from the endotracheal tube (ETT)
- System is purging due to fluid in the patient/sensor connection from ET administration of medications
- System is auto-zeroing
- Shock was delivered and system is resetting
- Loose FilterLine set to device connection

Loss of airway function

- Improper placement of ETT
- ETT dislodgment
- ETT obstruction

Physiological factors

- Apneic condition
- Loss of perfusion
- Exsanguination
- Massive pulmonary embolism
- Inadequate CPR

Cleaning

Accessories for CO₂ monitoring are disposable and are intended for single-patient use. Do not clean and reuse a FilterLine set. Dispose of the contaminated waste according to local protocols.

For information about cleaning the device, see *Cleaning the Device* (on page 218).

Troubleshooting Tips

Table 15 Troubleshooting Tips for EtCO₂ Monitoring

OBSERVATION	POSSIBLE CAUSE	CORRECTIVE ACTION
ALARM NO BREATH message appears and waveform is solid line at or near zero Note: Some software versions display Alarm Apnea instead of Alarm No Breath. The Alarm Apnea and Alarm No Breath messages are equivalent.	No breath has been detected for 30 seconds since last valid breath	<ul style="list-style-type: none"> Check the patient.
	FilterLine connection to device is loose	<ul style="list-style-type: none"> Twist FilterLine connector clockwise until tight and firmly seated.
	FilterLine set is disconnected from patient or ETT	<ul style="list-style-type: none"> Check ventilation equipment (if used) for leaks or disconnected tubing.
CO₂ FILTERLINE OFF message appears and waveform is "---"	FilterLine set disconnected or not securely connected to device	<ul style="list-style-type: none"> Connect FilterLine set to device port. Twist FilterLine connector clockwise until tight and firmly seated.
CO₂ FILTERLINE PURGING message appears and waveform is "---"	FilterLine set is kinked or clogged with fluid, or rapid altitude change occurred	<ul style="list-style-type: none"> Disconnect and then reconnect the FilterLine set. Twist FilterLine connector clockwise until tight and firmly seated.
CO₂ FILTERLINE BLOCKAGE message appears and waveform is "---"	The message appears after 30 seconds of unsuccessful purging	<ul style="list-style-type: none"> Disconnect and then reconnect the FilterLine set. Change the FilterLine set.
	FilterLine set is kinked or clogged	<ul style="list-style-type: none"> Twist FilterLine connector clockwise until tight and firmly seated..
CO₂ INITIALIZING message appears and waveform is "---"	FilterLine set connected to device while module is initializing	<ul style="list-style-type: none"> None.
	Defibrillation shock delivered	<ul style="list-style-type: none"> None. System resets automatically within 20 seconds.
AUTO ZEROING message appears and waveform is "---"	Module is performing self-maintenance	<ul style="list-style-type: none"> None.
	Defibrillation shock delivered	<ul style="list-style-type: none"> None. System resets automatically within 20 seconds.
EtCO ₂ values are erratic	FilterLine connection to device is loose	<ul style="list-style-type: none"> Twist FilterLine connector clockwise until tight and firmly seated.
	A leak in the FilterLine set	<ul style="list-style-type: none"> Check for connection leaks and line leaks to patient, and correct, if necessary.
	A mechanically ventilated patient breathes spontaneously or patient is talking	<ul style="list-style-type: none"> No action required.

Monitoring ETCO₂

OBSERVATION	POSSIBLE CAUSE	CORRECTIVE ACTION
EtCO ₂ values are consistently higher than expected	Physiological cause such as COPD	<ul style="list-style-type: none"> None.
	Inadequate ventilation	<ul style="list-style-type: none"> Check ventilator, increase ventilatory rate/bagging.
	Patient splinting during breathing	<ul style="list-style-type: none"> Supporting measures such as pain relief.
	Improper calibration	<ul style="list-style-type: none"> Contact qualified service personnel.
EtCO ₂ values are consistently lower than expected	FilterLine connection to device is loose	<ul style="list-style-type: none"> Twist FilterLine connector clockwise until tight and firmly seated..
	Physiological cause	<ul style="list-style-type: none"> See Physiological factors in CO₂ Detection.
	Hyperventilation	<ul style="list-style-type: none"> Check ventilator, decrease ventilatory rate/bagging.
	Improper calibration	<ul style="list-style-type: none"> Contact qualified service personnel.
CO ₂ waveform stays elevated for several seconds	Expiration is prolonged due to bagging technique	<ul style="list-style-type: none"> Release bag reservoir completely with expiration. Observe that elevated baseline returns to normal level.
Sudden extreme increase in EtCO ₂	Fluid has entered CO ₂ module	<ul style="list-style-type: none"> Contact qualified service personnel.
XXX appears instead of EtCO ₂ value	CO ₂ module malfunction	<ul style="list-style-type: none"> Turn device off and then on again. If problem persists, contact qualified service personnel.
There is no EtCO ₂ value and the CO ₂ waveform is flat	Measured CO ₂ is less than 3.5 mmHg	<ul style="list-style-type: none"> See CO₂ Detection.

Note: To decrease the likelihood of the FilterLine connection coming loose during use, hand-straighten the tubing after removal from the package before connecting to patient or device.

For general troubleshooting tips, see General Troubleshooting Tips (on page 220).

Monitoring Invasive Pressure

Intended Use

The LIFEPAK 15 invasive pressure (IP) monitor is intended for measuring arterial, venous, intracranial, and other physiological pressures using an invasive catheter system with a compatible transducer.

The IP monitor is a tool to be used in addition to patient assessment. Care should be taken to assess the patient at all times; do not rely solely on the IP monitor.

Indications

Invasive pressure monitoring is indicated for use in patients who require continuous monitoring of physiological pressures in order to rapidly assess changes in the patient's condition or response to therapy. It may also be used to aid in medical diagnosis.

Contraindications

None known.

IP Monitoring Warnings

WARNING

Possible Inaccurate Pressure Readings, Air Embolism, Blood Loss, or Loss of Sterility

Before use, carefully read these operating instructions, and the transducer and infusion set instructions for use and precautionary information.

WARNING

Inaccurate Pressure Readings

Pressure readings should correlate with the patient's clinical presentation. If readings do not correlate, verify that the zeroing stopcock is positioned at the patient's zero reference, rezero the transducer, and/or check the transducer with a known or calibrated pressure. Manually check cuff blood pressure.

WARNING

Inaccurate Pressure Readings

Changing the patient's position changes the zero reference level. Relevel the transducer's zeroing stopcock any time the patient's position is changed.

WARNING

Possible Patient Injury or Equipment Damage

Use only IP transducers that are specified for use with this device. Protection of the device against defibrillator discharge is dependent on the use of IP transducers that are specified by Physio-Control.

WARNING

Possible Lethal Arrhythmia

Ventricular fibrillation may be induced if the isoelectric barrier of the transducer is disrupted. The isoelectric barrier within the transducer may be disrupted if the transducer body is damaged. Do not use a transducer that is visibly damaged or leaking fluid.

WARNING

Increased Intracranial Pressure

Do not use a continuous flush device with transducers used for intracranial monitoring.

IP Monitoring

Two channels are available for invasive pressure monitoring, with default labels P1 and P2 and the user-selectable labels shown in the following table.

Table 16 IP Labels and Descriptions

LABEL	DESCRIPTION
ART	Arterial Pressure
PA	Pulmonary Artery Pressure
CVP	Central Venous Pressure
ICP	Intracranial Pressure
LAP	Left Atrial Pressure

When the default labels P1 and P2 are used, the IP monitoring area displays systolic, diastolic, and mean pressures. When ICP, LAP, or CVP labels are used, the IP monitoring area displays mean pressure in large type. Systolic and diastolic pressures are not displayed.

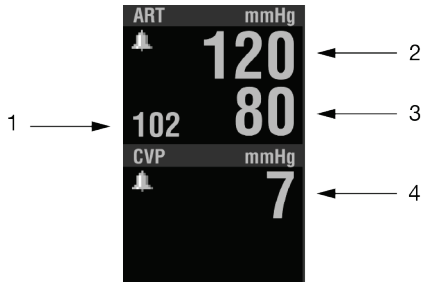

Figure 28 IP Labels

FIGURE LEGEND

- 1 ART mean pressure
- 2 ART systolic pressure
- 3 ART diastolic pressure
- 4 CVP mean pressure

Because pressures can change in a short time, data should be checked regularly during vital sign monitoring.

How IP Monitoring Works

IP monitoring involves the conversion of fluid pressure into an electrical signal. The conversion is accomplished with a pressure transducer. The transducer is connected to a patient’s indwelling pressure catheter using a special assembly of tubing, stopcocks, adapters, flush valves, and fluids, commonly known as a flush system. The transducer translates the pressure wave into an electrical signal. A well-functioning flush system is essential for obtaining undistorted waveforms and accurate information.

IP monitoring is available on either Channel 2 or 3. The IP monitor is compatible with industry standard (IEC 60601-2-34) pressure transducers with 5µV/V/mmHg sensitivity. The transducer must provide defibrillation protection of at least 360 joules. The following IP transducers may be used with the LIFEPAK 15 monitor/defibrillator.

MANUFACTURER	DESCRIPTION
Utah Medical	Deltran® Disposable Pressure Transducer
Edwards Lifesciences	TruWave® Disposable Pressure Transducer
ICU Medical	Transpac® IV Disposable Pressure Transducer

An invasive pressure adapter cable is used to connect the transducer to the monitor. The IP connector is a 6-pin type 3102A-14S-6S connector. The connector pinout has the following configuration, counterclockwise from 12 o’clock, viewed from the front of the LIFEPAK 15 monitor/defibrillator.

A pin = - signal	B pin = + excitation	C pin = + signal
D pin = - excitation	E pin = shield	F pin = unlabeled

IP Monitoring Procedure

Prepare a flush system according to local protocols. Position the transducer at the patient's phlebostatic axis (zero-reference level).

To avoid offset errors, a zero reference must be established before any meaningful pressure readings are obtained. This is done by opening the transducer stopcock to air so that atmospheric pressure becomes the reference.

The P1 or P2 connector and Channel 2 or 3 can be used for IP monitoring. P1 and Channel 2 are used in these instructions.

To monitor IP:

1. Prepare the transducer system according to the operating instructions provided with the transducer and your local protocol.
2. Press **ON**.
3. Connect the IP cable to the transducer and to the P1 port on the monitor.
4. Use the default label **P1** or select **ART, PA, CVP, ICP, or LAP**. To change the label, select the P1 area. From the menu, select **P1**. Select a label from the list.
5. Use the **SPEED DIAL** to outline and select **CHANNEL 2** on the Home Screen. From the Channel 2 menu, select **WAVEFORM** and then select the label that is desired for the waveform.
6. Open the transducer's stopcock to air to zero the transducer and remove stopcock cap. Select the **P1** area. Select **ZERO** from the menu. The message **P1 ZEROED** appears when zeroing is complete and the pressure values are displayed as zeros.
7. Close the stopcock to air. The patient's pressure waveform should be displayed. A scale is automatically selected to display the pressure. Confirm that pressure amplitude correlates with the digital readout.

Note: If you place a cap on an open port before you close the port to air, an error message may appear. You will be required to zero the transducer again.

If pressure alarms are desired, set the alarms after you obtain a satisfactory waveform. Error or alarm messages appear in the message area at the bottom of the screen. For more information, see Alarms (on page 41).

IP Scale Options

The IP monitor can display pressures from -30 to 300 mmHg. After zeroing the transducer pressure, the monitor automatically selects one of the following scales based on the patient's measured pressure:

- -30 to 30 mmHg
- 0 to 60 mmHg
- 0 to 120 mmHg
- 0 to 150 mmHg
- 0 to 180 mmHg
- 0 to 300 mmHg

You can also manually select one of these scales or autoscale to readjust the waveform within the channel.

To change the scale:

1. Use the **SPEED DIAL** to outline and select the P1 area. The P1 menu appears.
2. From the menu, select **SCALE** and then choose a scale from the list.

Cleaning and Inspection

IP transducers are disposable and are intended for single-patient use. Do not clean and reuse transducers. Dispose of the contaminated waste according to local protocols.

IP cables are reusable and may be cleaned. To clean the reusable IP cable:

1. Disconnect the cable from the monitor.
2. Inspect the cable for damage or wear.
3. Use a clean, soft cloth dampened with a germicidal solution to wipe clean.
4. Allow to dry before reconnecting the cable to the monitor.

For information about cleaning the device, see *Cleaning the Device* (on page 218).

Troubleshooting Tips

The error messages in the following table use the text **PX** to represent any of the labels for invasive pressure, including P1, P2, and the user-selectable labels ART, PA, CVP, ICP, and LAP.

Table 17 Troubleshooting Tips for IP Monitoring

OBSERVATION	POSSIBLE CAUSE	CORRECTIVE ACTION
Invasive pressure value is blank	No transducer is connected	<ul style="list-style-type: none"> Connect the transducer to the cable, and the cable to the monitor.
No scale appears next to the waveform	The zero reference has not been established	<ul style="list-style-type: none"> Zero the transducer.
PX NOT ZEROED message appears	The zero reference has not been established	<ul style="list-style-type: none"> Zero the transducer.
PX ZERO FAILED message appears	An unsuccessful attempt has been made to set a zero reference value	<ul style="list-style-type: none"> Make sure that the transducer is open to air and repeat the attempt to zero.
Dampened waveform	Loose connection	<ul style="list-style-type: none"> Check the entire system for leaks. Tighten all connections. Replace any defective stopcocks.
	Tubing too long or too compliant	<ul style="list-style-type: none"> Use short, stiff tubing with large diameter.
	Thrombus formation, air bubbles, or blood left in catheter after blood draw	<ul style="list-style-type: none"> Use syringe to draw back air or particles in catheter, and then flush system.
	Kinked catheter, catheter tip against vessel wall, arterial spasm	<ul style="list-style-type: none"> Reposition catheter. Anchor catheter to skin at insertion site.
Resonating waveform	Tubing too long	<ul style="list-style-type: none"> Use short, stiff tubing with a large diameter.
No waveform. No pressure reading.	Transducer closed to patient	<ul style="list-style-type: none"> Check patient. Check stopcock positions and monitor setup.
	Defibrillator shock just delivered	<ul style="list-style-type: none"> None.
Invasive BP lower than cuff BP	Transducer level higher than the heart	<ul style="list-style-type: none"> Reposition transducer to correct height.
	Loose connection	<ul style="list-style-type: none"> Tighten all connections.
	Thrombus formation, air bubbles, or blood in catheter, kinking, or arteriospasm	<ul style="list-style-type: none"> Use syringe to draw back air or particles in catheter, and then flush system.
	Improper zero reference	<ul style="list-style-type: none"> Open stopcock to air and rezero transducer.
	Defective transducer	<ul style="list-style-type: none"> Replace transducer.

OBSERVATION	POSSIBLE CAUSE	CORRECTIVE ACTION
Invasive BP higher than cuff BP	Transducer level lower than the heart	<ul style="list-style-type: none"> • Reposition transducer to correct height.
	Improper zero reference	<ul style="list-style-type: none"> • Rezero.
	Catheter whip artifact	<ul style="list-style-type: none"> • Change catheter tip position. • Use mean pressure values (mean pressure is less affected by extremes and will therefore reflect a more accurate reading).
Inability to flush system	Pressure bag leaking	<ul style="list-style-type: none"> • Keep positive pressure in flush bag at all times. • Remove dressing to check for external kinking.
	Partially kinked or obstructed catheter	<ul style="list-style-type: none"> • Replace catheter, if clotted.
Inability to zero system	Stopcock not open to air or defective	<ul style="list-style-type: none"> • Check stopcock position. Replace any defective stopcocks.
	Defective transducer	<ul style="list-style-type: none"> • Replace transducer.
System has been zeroed but continues to indicate zero reference required	Steps to zero system performed in wrong order	<ul style="list-style-type: none"> • Close stopcock to air before placing cap on port.
Catheter whip (fling) artifact Pulmonary Artery	Excessive catheter movement. Motion of the catheter tip within the vessel accelerates fluid movement in the catheter, causing artifact to be superimposed on the pressure wave, increasing readings by 10–20 mmHg.	<ul style="list-style-type: none"> • Change catheter tip position. • Use mean pressure values (mean pressure is less affected by extremes and therefore reflects a more accurate reading).
Permanent Pulmonary Wedge Pressure (PWP) tracing (wedge tracing persists after balloon deflation)	Catheter tip partially clotted	<ul style="list-style-type: none"> • Use syringe to aspirate, and then flush.
	Catheter migrated distally in pulmonary artery	<ul style="list-style-type: none"> • Observe PA waveform before balloon inflation. Flattening of the waveform could indicate wedging with balloon deflated. Turn patient side to side in Trendelenburg position, or stimulate cough in attempt to dislodge catheter. • Retract catheter with balloon deflated until proper position is obtained. • Minimize chances of catheter advancement by firmly anchoring catheter at insertion site.

Monitoring Invasive Pressure

OBSERVATION	POSSIBLE CAUSE	CORRECTIVE ACTION
Failure to obtain PWP	Malposition of catheter tip	<ul style="list-style-type: none">• Reposition catheter.
	Leak in balloon. Ruptured balloon.	<ul style="list-style-type: none">• Replace catheter.
Progressive elevation of PWP	Overinflation	<ul style="list-style-type: none">• Inflate balloon in small increments while watching scope for confirmation of wedging. Use only enough air to wedge. Do not use more than the volume recommended by the manufacturer.
	Catheter migrated distally in pulmonary artery	<ul style="list-style-type: none">• Reposition catheter.

For general troubleshooting tips, see General Troubleshooting Tips (on page 220).

Monitoring Continuous Temperature

Intended Use

The LIFEPAK 15 temperature monitor is intended for continuous monitoring of body temperature.

Indications

Temperature monitoring is indicated for use in patients who require continuous monitoring of body temperature.

Contraindications

None known.

Temperature Monitoring Warnings

WARNING

Possible Inaccurate Temperature Readings

Using temperature probes or cables that are not approved by Physio-Control may cause improper temperature monitoring performance and invalidate safety agency certifications. Use only probes and cables that are specified in these operating instructions.

WARNING

Possible Inaccurate Temperature Readings

The Measurement Specialties 4400 Series temperature probes must be used with the adapter cable that is listed on the Physio-Control website. Using other manufacturers' connector cables may cause the device to perform improperly.

WARNING

Infection Hazard

The temperature probe is disposable and intended for single-patient use. Do not clean and reuse temperature probes. Dispose of contaminated waste according to local protocols.

WARNING

Possible Strangulation

Carefully route the temperature probe cable to reduce the possibility of patient entanglement or strangulation.

How Temperature Monitoring Works

The temperature probe contains a thermistor which converts temperature to electrical resistance. The LIFEPAK 15 monitor/defibrillator measures the resistance and converts it into degrees Celsius or Fahrenheit. The probe accuracy is $\pm 0.1^{\circ}\text{C}$.

Note: Celsius or Fahrenheit reporting may be selected in Setup mode. For more information, see the *LIFEPAK 15 Monitor/Defibrillator Setup Options* provided with your device.

The temperature area of the home screen is blank until a temperature value between 24.8°C and 45.2°C (76.6° and 113.4°F) is detected. When a temperature value in this range is detected, the value is automatically displayed.

After a valid body temperature between 31° and 41°C (87.8° and 105.8°F) is detected, the device monitors the temperature value for possible sensor dislodgement or disconnection. If the device detects a temperature outside of the valid body temperature range, the **TEMP: CHECK SENSOR** message appears. The following table shows the screen messages and temperature values that are displayed for each temperature range.

Table 18 Temperature Values and Messages

TEMPERATURE	MESSAGE	TEMP VALUE DISPLAY
Less than 24.8°C (76.6°F)	TEMP: CHECK SENSOR	Dashes (---)
24.8° to 30.9°C (76.6° to 87.6°F)	TEMP: CHECK SENSOR	Current temp value
31° to 41°C (87.8° to 105.8°F)	No message (valid range)	Current temp value
41.1° to 45.2°C (106° to 113.4°F)	TEMP: CHECK SENSOR	Current temp value
Greater than 45.2°C (113.4°F)	TEMP: CHECK SENSOR	Dashes (---)
Temperature probe disconnected	TEMP: CHECK SENSOR	Dashes (---)

The temperature monitor performs an accuracy check each time it is turned on, and periodically while monitoring temperature. If the temperature accuracy check fails, the message **TEMP: ACCURACY OUTSIDE LIMITS** is displayed, and the temperature value is "XXX".

Temperature Monitoring Equipment

The following accessories are required for temperature monitoring:

- Temperature adapter cable
- Measurement Specialties 4400 Series disposable temperature probe. You can use the following probe types with the LIFEPAK 15 monitor/defibrillator:
 - Esophageal/rectal
 - Foley catheter
 - Skin (Note: Measurement Specialties skin temperature probe 4499HD is approved for use with the LIFEPAK 15 monitor/defibrillator. Do not use Measurement Specialties part number 4499.)

For a list of the accessories that are intended for use with the LIFEPAK 15 monitor/defibrillator, contact your Physio-Control representative or see the LIFEPAK 15 Monitor/Defibrillator Accessory Catalog at www.physio-control.com. Carefully read the Instructions for Use that are provided with the probes and connector cable for sensor placement instructions, use instructions, warnings, cautions, and specifications.

IMPORTANT! The Instructions for Use that are provided with the Measurement Specialties temperature probes refer to a connector cable that is not compatible with the LIFEPAK 15 monitor/defibrillator. Only use the adapter cable that is approved for use with the LIFEPAK 15 monitor/defibrillator.

Temperature Monitoring Procedure

1. Connect the temperature adapter cable to the TEMP port on the monitor/defibrillator.
2. Connect the temperature probe to the temperature adapter cable.
3. Attach the temperature probe to the patient as described in the temperature probe Instructions for Use.

Notes:

- The temperature area on the display is not activated until the monitor/defibrillator detects a temperature between 24.8° and 45.2°C (76.6° and 113.4°F). To manually activate the temperature monitoring area, use the **SPEED DIAL** to outline and select the temperature area on the Home Screen. From the menu, select **ON**.
 - The temperature probe may require 3 minutes to equilibrate after placement on the patient monitoring site.
4. Confirm that the temperature reading appears and is stable.
 5. Use the default label **TEMP** or select one of the user-selectable labels shown in the following table. To change the label, select the **TEMP** area. From the menu, select **TEMP**. Select a label from the list.

Table 19 TEMP Labels and Descriptions

LABEL	DESCRIPTION
T-esoph	Esophageal Temperature
T-naso	Nasopharyngeal Temperature
T-bladder	Bladder Temperature
T-rectal	Rectal Temperature
T-skin	Skin Temperature

Cleaning and Disposal

Temperature probes are disposable and intended for single-patient use. Do not clean and reuse temperature probes. Dispose of the contaminated waste according to local protocols.

Temperature adapter cables are reusable and may be cleaned. To clean the reusable temperature cable:

1. Disconnect the cable from the monitor.
2. Use a clean, soft cloth dampened with a germicidal solution to wipe clean. See *Cleaning the Device* (on page 218) for a list of acceptable cleaning solutions.
3. Allow to dry before reconnecting the cable to the monitor.

For information about cleaning the device, see *Cleaning the Device* (on page 218).

Troubleshooting Tips

Table 20 Troubleshooting Tips for Temperature Monitoring

OBSERVATION	POSSIBLE CAUSE	CORRECTIVE ACTION
CHECK SENSOR message appears and value is "---"	Temperature value is out of range	<ul style="list-style-type: none"> • Check that probe is positioned properly.
	Temperature probe is dislodged or positioned incorrectly	<ul style="list-style-type: none"> • Check that probe is positioned properly.
	Probe not connected to cable, or cable not connected to device	<ul style="list-style-type: none"> • Check that probe and cable are connected properly.
	Damaged cable or probe	<ul style="list-style-type: none"> • Replace damaged cable or probe.
CHECK SENSOR message appears while value is displayed	Temperature probe is dislodged and value is below 31°C (87.8°F)	<ul style="list-style-type: none"> • Check that probe is positioned properly.
	Temperature probe is dislodged and value is above 41.0°C (105.8°F)	<ul style="list-style-type: none"> • Check that probe is positioned properly.
TEMP: ACCURACY OUTSIDE LIMITS message appears and value is XXX	Temperature accuracy check failed	<ul style="list-style-type: none"> • Turn device off and then on again. • If problem persists, contact qualified service personnel.
XXX appears in place of temperature reading	Temperature module is not calibrated	<ul style="list-style-type: none"> • Turn device off and then on again. • If problem persists, contact qualified service personnel.
	Temperature module failed	<ul style="list-style-type: none"> • Turn device off and then on again. • If problem persists, contact qualified service personnel.

OBSERVATION	POSSIBLE CAUSE	CORRECTIVE ACTION
Temperature area of home screen is blank	Initial temperature not automatically displayed until device detects temperature between 24.8° and 45.2°C (76.6° and 113.4°F)	<ul style="list-style-type: none"> Allow up to 3 minutes for probe to equilibrate. Check that probe is positioned properly.
	Temperature probe not detected by device	<ul style="list-style-type: none"> Check connections between probe, adapter cable, and device. Check that the sensor is approved for use with the LIFEPAK 15 monitor/defibrillator. Contact qualified service personnel.

Vital Sign and ST Segment Trends

Intended Use

The trends feature of the LIFEPAK 15 monitor/defibrillator provides the ability to graphically display and document the patient's vital signs (VS) and ST segment measurements for up to eight hours. VS trending is intended for use with any patient who requires continuous monitoring of vital signs over an extended period of time to identify changes in patient condition and to document patient response to therapy. ST trending is intended for use with patients suspected of having acute ischemic events, such as unstable angina, and for patients during treatment of an acute ischemic event. ST segment measurement is initiated using a 12-lead ECG and is derived using the University of Glasgow 12-Lead ECG Analysis Program.

VS and ST Trends Warning

WARNING

Inaccurate Interpretation of Patient Status

Vital sign and ST graphs are tools to be used in addition to patient assessment. Artifact and noise may produce spurious data. Ensure artifact-free monitoring as much as possible and assess the patient frequently to confirm the appropriateness of monitor data.

How VS Trends Work

Each active vital sign can be displayed graphically for time ranges of 30 minutes, and 1, 2, 4, and 8 hours. The vital signs are HR, SpO₂, SpCO, SpMet, CO₂, Temp, and RR; and systolic, diastolic, and mean pressures. Data is sampled every 30 seconds. If valid data is not available, a blank space is substituted on the graph. NIBP values are plotted only when an NIBP measurement is obtained. VS measurements are not averaged or filtered. No messages or alarms occur based on changes in VS measurements.

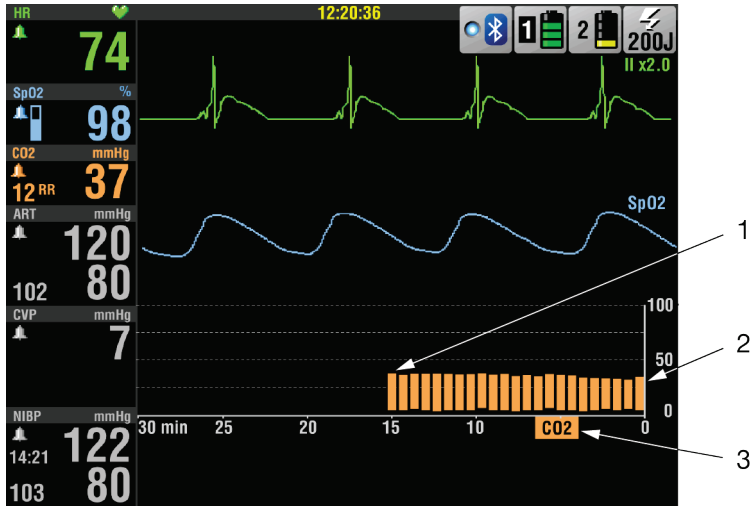

Figure 29 EtCO₂ Trend Graph

FIGURE LEGEND

- 1 First EtCO₂ measurement
- 2 Most recent EtCO₂ measurement
- 3 VS label



Figure 30 Pressure Trend Graph

FIGURE LEGEND

- 1 Systole pressure
- 2 Diastolic pressure
- 3 VS label

How ST Trends Work

ST measurements can be displayed graphically for time ranges of 30 minutes, and 1, 2, 4, and 8 hours. ST trending is initiated by obtaining the patient’s first 12-lead ECG. The ST J-point (STJ) is the part of the ST segment that is measured (see the following figure). The STJ measurement is plotted on the ST trend graph (see Figure, ST Trend Graph (on page 114)).

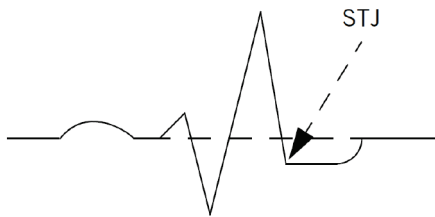

Figure 31 STJ Measurement

When all leads of the 12-lead ECG cable are attached to the patient, STJ measurements are obtained automatically every 30 seconds. If a lead is off, or the ECG data is too noisy, ST measurements are not obtained and the graph shows a blank for that time period. If an STJ measurement in any lead deviates from the initial measurement by 1 mm (0.1 mV) or more and the deviation persists for 2.5 minutes, the monitor automatically prints another 12-lead ECG. Manual requests for 12-lead ECGs do not affect ST trending or automatic printing.

Interpreting the ST Trend Graph

Using the first 12-lead ECG, the monitor identifies the presence of any STJ displacement, either negative or positive, and the lead that has the most STJ displacement. When **AUTO** is selected, the lead that has the most STJ displacement is shown on the graph. The STJ is measured every 30 seconds thereafter.

The following figure shows an example of an ST trend graph. The elapsed time goes from right to left across the screen. The most current STJ measurement is on the far right. Each time an STJ measurement is obtained, it is compared to the first STJ or baseline measurement. The bars represent the change in the STJ compared to the first measurement.

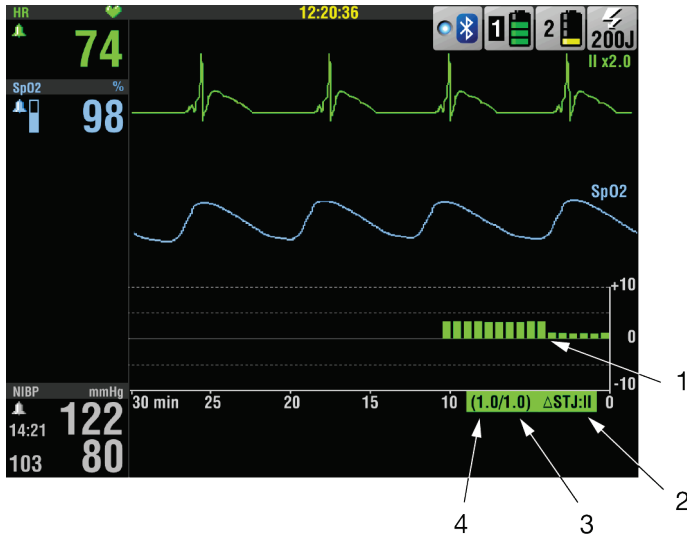

Figure 32 ST Trend Graph

FIGURE LEGEND

- 1 Increase and then decrease in STJ
- 2 Lead
- 3 Change in STJ
- 4 Current STJ

This ST trend graph depicts the changes in STJ from a patient's first 12-lead ECG over 10 minutes of monitoring time. The patient's initial ECG showed no ST elevation in any lead. Then the patient developed 3 mm elevation in Lead II. This change in ST elevation is represented by the vertical bars and lasted approximately 5 minutes. (Each vertical bar represents a 30-second interval). After treatment was initiated, the ST decreased to the current STJ measurement of 1.0, but is still positive compared to the initial ECG.

The annotation (1.0/1.0) means that the current STJ measurement is elevated 1.0 mm and represents a change of 1.0 mm from the initial ECG. To confirm the value of the initial 12-lead ECG STJ measurement, subtract the STJ change from the current STJ measurement, for example, $1.0 - 1.0 = 0$. You can display the ST graph of other leads.

Displaying and Printing Trend Graphs

The trend graph for any active vital sign or ST measurement can be displayed in Channel 2 or 3. The example in Figure, ST Trend Graph (on page 114), shows the trend graph in Channel 3. Only two trend graphs can be displayed at a time, but the device collects trend data on all active vital sign values.

To display trend graphs:

1. Rotate the **SPEED DIAL** to outline Channel 2 or 3, and then press the **SPEED DIAL** to select the channel. The Channel menu appears.
2. Select **WAVEFORM**, and then select **TREND**.
3. Select **SOURCE**, and then select the desired VS or ST.
4. The default setting for **SCALE** and **RANGE** is **AUTO**. When **AUTO** is used, the monitor automatically updates the scale so that all values are displayed and all data from Power On to the present time is visible. If you change scale or range, some data may not be visible because it is off scale or out of range.
5. Press **HOME SCREEN**. The graph for the selected VS or ST appears in the channel.

Note: To initiate ST trends, you must obtain a 12-lead ECG. The initial ECG provides the baseline ST measurement and initiates the ST trends feature.

To print trend graphs:

1. Press **OPTIONS**. The Options menu appears.
2. Rotate and then press the **SPEED DIAL** to select **PRINT**.
3. Select **REPORT**, and then select **TREND SUMMARY**.
4. Select **PRINT**. The Trend Summary Report prints graphs of all actively monitored VS and ST trends.

VS and ST Monitoring Considerations

For best results, consider the following:

- The ability of the patient to cooperate and be relaxed. Patients who are restless can produce noisy physiological signals. Noisy signals can result in inaccurately high or low data measurements.
- The quality of the physiological signal. If the ECG has significant artifact, the HR may have spurious measurements. Noisy 12-lead ECGs may need to be overridden, and ST measurements will not be obtained.
- The expected length of time the patient is to be monitored. VS graphs of the patient monitored for only a short time (for example, 15 minutes) may not provide enough data to identify gradual changes in patient condition.
- The patient ECG rhythm. Diagnosis of ST associated ischemia is inhibited by certain ECG findings such as left bundle branch block and ventricular pacing.

Therapy

This chapter describes patient therapy.

General Therapy Warnings and Cautions	119
Therapy Electrode and Standard Paddle Placement.....	121
Automated External Defibrillation (AED).....	123
Manual Defibrillation.....	137
Synchronized Cardioversion Procedure	143
Noninvasive Pacing	148
Pediatric ECG Monitoring and Manual Mode Therapy Procedures	154

General Therapy Warnings and Cautions

WARNING**Shock Hazard**

The defibrillator delivers up to 360 joules of electrical energy. When discharging the defibrillator, do not touch the paddle electrode surfaces or disposable therapy electrodes.

WARNING**Shock Hazard**

If a person is touching the patient, bed, or any conductive material in contact with the patient during defibrillation, the delivered energy may be partially discharged through that person. Clear everyone away from contact with the patient, bed, and other conductive material before discharging the defibrillator.

WARNING**Shock Hazard**

Do not discharge the defibrillator into the open air. To remove an unwanted charge, change the energy selection, select disarm, or turn off the defibrillator.

WARNING**Possible Fire, Burns, and Ineffective Energy Delivery**

Do not discharge standard paddles on top of therapy electrodes or ECG electrodes. Do not allow standard paddles (or therapy electrodes) to touch each other, ECG electrodes, lead wires, dressings, transdermal patches, etc. Such contact can cause electrical arcing and patient skin burns during defibrillation and may divert defibrillating energy away from the heart muscle.

WARNING**Possible Skin Burns and Ineffective Energy Delivery**

Therapy electrodes that are dried out or damaged may cause electrical arcing and patient skin burns during defibrillation. Do not use therapy electrodes that have been removed from foil package for more than 24 hours. Do not use electrodes beyond Use By date. Check that electrode adhesive is intact and undamaged. Replace adult therapy electrodes after 50 shocks or pediatric therapy electrodes after 25 shocks.

WARNING

Possible Skin Burns

During defibrillation or pacing, air pockets between the skin and therapy electrodes may cause patient skin burns. Apply therapy electrodes so that entire electrode adheres to skin. Do not reposition the electrodes once applied. If the position must be changed, remove and replace with new electrodes.

WARNING

Possible Skin Burns

Electrodes and cables that are not specified for use with the LIFEPAK 15 defibrillator may malfunction and cause skin burns. Use only the electrodes and cables that are specified for use with the LIFEPAK 15 defibrillator.

WARNING

Possible Defibrillator Shutdown

The large current draw required for defibrillator charging may cause the defibrillator to reach a shutdown voltage level with no low battery indication. If the defibrillator shuts down without warning or if a replace battery warning occurs, immediately replace the battery with another fully charged battery.

WARNING

Possible Interference with Implanted Electrical Device

Defibrillation may cause implanted devices to malfunction. Place standard paddles or therapy electrodes away from implanted devices if possible. Check implanted device function after defibrillation.

CAUTION

Possible Equipment Damage

Prior to using this defibrillator, disconnect from the patient all equipment that is not defibrillator-protected.

Therapy Electrode and Standard Paddle Placement

The following paragraphs describe therapy electrode and standard paddle skin preparation and placement, including special placement situations.

Patient Skin Preparation

Prepare the patient's skin:

- Remove all clothing from the patient's chest.
- Remove excessive chest hair as much as possible. Avoid nicking or cutting the skin if using a shaver or razor. If possible, avoid placing electrodes over broken skin.
- Clean and dry the skin, if necessary. Remove any ointment on the patient's chest.
- Briskly wipe the skin dry with a towel or gauze. This mildly abrades the skin and removes oils, dirt, and other debris for better electrode adhesion to the skin.
- Do not use alcohol, tincture of benzoin, or antiperspirant to prep the skin.

Anterior-Lateral Placement

Anterior-lateral placement is used for ECG monitoring, defibrillation, synchronized cardioversion, and noninvasive pacing.

To perform anterior-lateral placement:

1. Place either the ♥ therapy electrode or **APEX** paddle lateral to the patient's left nipple in the midaxillary line, with the center of the electrode in the midaxillary line, if possible. See the following figure.

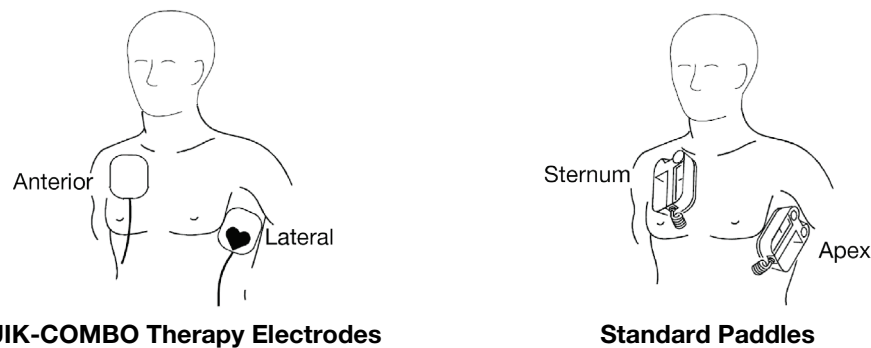

Figure 33 Anterior-Lateral Placement

2. Place the other therapy electrode or **STERNUM** paddle on the patient's upper right torso, lateral to the sternum and below the clavicle as shown in the preceding figure.

Anterior-Posterior Placement

Anterior-posterior is an alternative position for noninvasive pacing, manual defibrillation, and synchronized cardioversion, but not for ECG monitoring or AED mode. The ECG signal obtained through electrodes in this position is not a standard lead.

To perform anterior-posterior placement:

1. Place either the ♥ or + therapy electrode over the left precordium as shown in the following figure. The upper edge of the electrode should be below the nipple. Avoid placement over the nipple, the diaphragm, or the bony prominence of the sternum, if possible.
2. Place the other electrode behind the heart in the infrascapular area as shown in the following figure. For patient comfort, place the cable connection away from the spine. Do not place the electrode over the bony prominences of the spine or scapula.

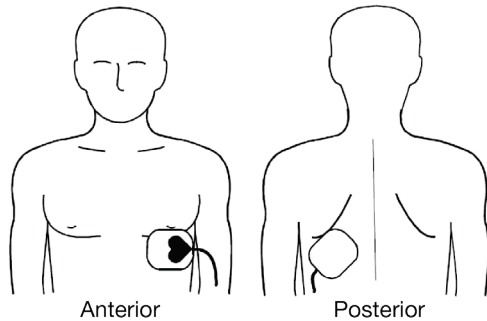

Figure 34 Anterior-Posterior Placement

Special Situations for Electrode or Paddle Placement

When placing therapy electrodes or standard paddles, be aware of the special requirements in the following possible situations.

Synchronized Cardioversion

Alternative placements for cardioversion of atrial fibrillation include a) place the ♥ therapy electrode over the left precordium and the other electrode on the patient's right posterior infrascapular area; or b) place the ♥ therapy electrode to the right of the sternum and the other electrode on the patient's posterior left infrascapular area.

Obese Patients or Patients with Large Breasts

Apply therapy electrodes or standard paddles to a flat area on the chest, if possible. If skin folds or breast tissue prevent good adhesion, it may be necessary to spread skin folds apart to create a flat surface.

Thin Patients

Follow the contour of the ribs and spaces when pressing therapy electrodes onto the torso. This action limits air spaces or gaps under the electrodes and promotes good skin contact.

Patients with Implanted Devices

Implanted devices such as cardiac defibrillators, pacemakers, or other devices may absorb energy from a LIFEPAK 15 defibrillator shock or be damaged by the shock. If possible, place therapy electrodes or standard paddles in the standard placements but away from the implanted device. Treat the patient like any other patient who requires care. If defibrillation is unsuccessful, it may be necessary to try alternate electrode placement (anterior-posterior).

Automated External Defibrillation (AED)

Intended Use

When used in AED mode, the LIFEPAK 15 monitor/defibrillator is a semiautomatic defibrillator that provides a prompted treatment protocol and ECG analysis using a patented Shock Advisory System™ (SAS). This software algorithm analyzes the patient's electrocardiographic (ECG) rhythm and indicates whether or not a shockable rhythm is detected. AED mode requires operator interaction in order to defibrillate the patient.

AED mode is intended for use by personnel who are authorized by a physician or medical director and have, at a minimum, the following skills and training:

- CPR training
- AED training equivalent to that recommended by the American Heart Association (AHA) or the European Resuscitation Council (ERC)
- Training in the use of the LIFEPAK 15 monitor/defibrillator in AED mode

Indications

AED mode is to be used only on patients in cardiopulmonary arrest. The patient must be unconscious, pulseless, and not breathing normally before using the defibrillator to analyze the patient's ECG rhythm. In AED mode, the LIFEPAK 15 monitor/defibrillator is not intended for use on pediatric patients less than eight years old.

Contraindications

None known.

AED Warnings

WARNING

Possible Misinterpretation of Data

Do not analyze in a moving vehicle. Motion artifact may affect the ECG signal resulting in an inappropriate **SHOCK** or **NO SHOCK ADVISED** message. Motion detection may delay analysis. Stop vehicle and stand clear of patient during analysis.

WARNING

Possible ECG Misinterpretation

Do not place therapy electrodes in the anterior-posterior position when operating this defibrillator in AED mode. A **SHOCK** or **NO SHOCK** decision may be inappropriately advised. The shock advisory algorithm requires the electrodes to be placed in the anterior-lateral (Lead II) position.

WARNING

Pediatric Patient Safety Risk

In AED mode, this defibrillator is not intended for use on children under eight years old.

AED Mode

The LIFEPAK 15 monitor/defibrillator is set up to operate in Manual mode when it is turned on (factory default setting). The device can be set up to power on in AED mode by changing the Setup Options. The factory default settings for AED mode are identified in Setup Options Factory Default Settings (on page 250). The energy settings and other AED setup options are consistent with the 2010 and 2015 American Heart Association (AHA) and European Resuscitation Council (ERC) guidelines. The setup options can be changed according to local medical protocols. For more information, see the *LIFEPAK 15 Monitor/Defibrillator Setup Options* provided with your device.

The ECG is continuously displayed in AED mode; however, access to other functions such as **OPTIONS** is not allowed in AED mode. The CPR metronome automatically sounds during CPR times, but it can only be silenced and un-silenced in AED mode. For more information, see CPR Time and Metronome (on page 130).

You can exit AED mode's prompted protocol and enter Advisory Monitoring or Manual Mode. For more information about Advisory Monitoring, see Advisory Monitoring (on page 133). Access to Manual mode may be direct, require confirmation or a passcode, or not allowed, depending on how your defibrillator is set up. It is important to be thoroughly familiar with your monitor/defibrillator settings and operation before use.

AED Procedure

The following descriptions of AED prompts (voice and text) are based on the factory default settings for AED mode. The settings are consistent with the 2010 and 2015 American Heart Association (AHA) and European Resuscitation Council (ERC) guidelines. Changing the setup options may result in different AED behavior.

The CPR metronome automatically sounds during CPR times and can only be silenced and un-silenced.

To perform automated external defibrillation:

1. Verify that the patient is in cardiopulmonary arrest (unconscious, pulseless, not breathing normally).
2. Press **ON**.
3. Prepare the patient for electrode placement (see Patient Skin Preparation (on page 121)).

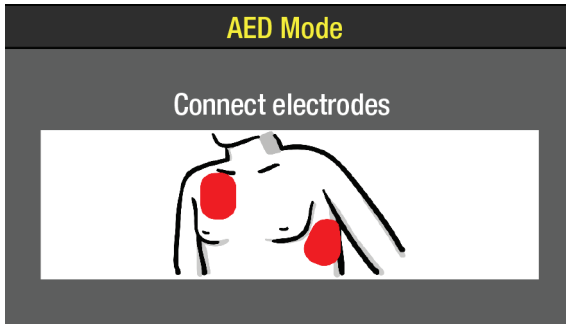

The **CONNECT ELECTRODES** prompts occur until the patient is connected to the AED. If possible, place the patient on a hard surface away from standing water.

4. Connect the therapy electrodes to the therapy cable and confirm cable connection to the defibrillator.
5. Apply the therapy electrodes to the patient's chest in the anterior-lateral position (see Anterior-Lateral Placement (on page 121)).

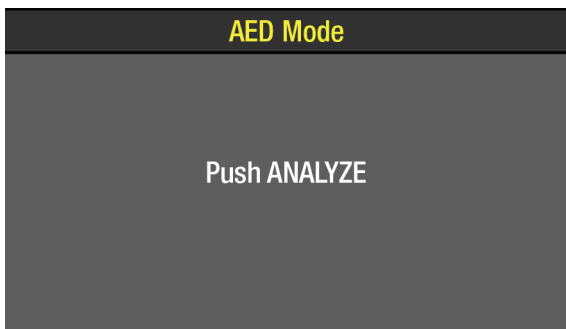

The **PUSH ANALYZE** prompts occur when the patient is properly connected to the AED.

6. Press **ANALYZE** to initiate the analysis. Stop CPR.

WARNING

Possible Misinterpretation of Data

Do not move the AED during analysis. Moving the AED during analysis may affect the ECG signal resulting in an inappropriate **SHOCK** or **NO SHOCK ADVISED** decision. Do not touch the patient or the AED during analysis.

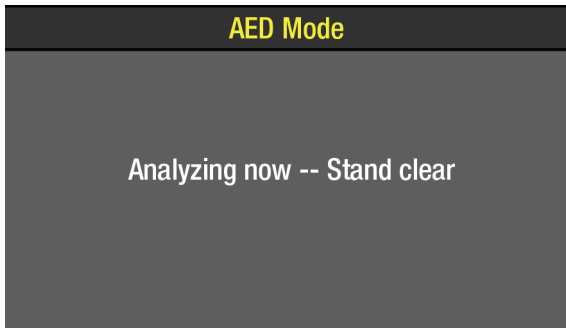

The **ANALYZING NOW—STAND CLEAR** prompts occur. The SAS analyzes the patient’s ECG in approximately 6 to 9 seconds and advises either **SHOCK ADVISED** or **NO SHOCK ADVISED**.

7. Continue to follow the screen messages and voice prompts provided by the AED.

Shock Advised

The following prompts occur when shock is advised:

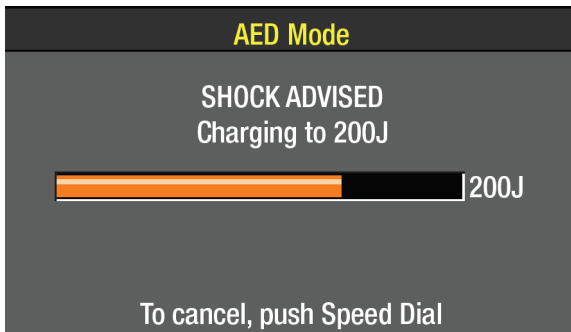

If the AED detects a shockable rhythm, the **SHOCK ADVISED** prompts occur. Charging to the joule setting for Shock #1 begins. A charging bar appears and a ramping tone sounds.

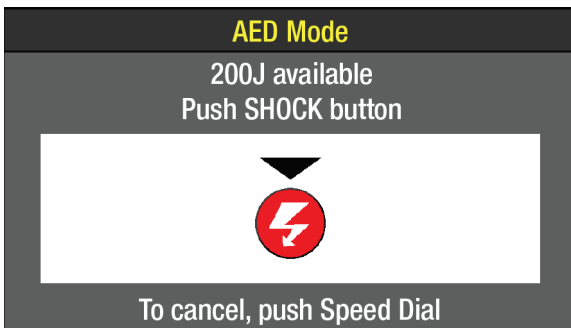

When charging is complete, the available energy is displayed. The **STAND CLEAR, PUSH SHOCK BUTTON!** (⚡) message occurs, followed by a “Shock ready” tone. Clear everyone away from touching the patient, bed, or any equipment that is connected to the patient. Press ⚡ (shock) to deliver energy to the patient.

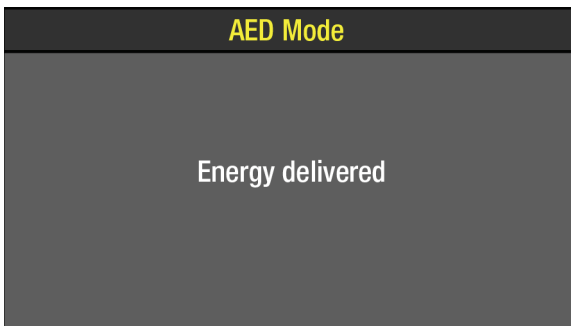

When the ⚡ (shock) button is pressed, the **ENERGY DELIVERED** message occurs indicating that the energy transfer was completed.

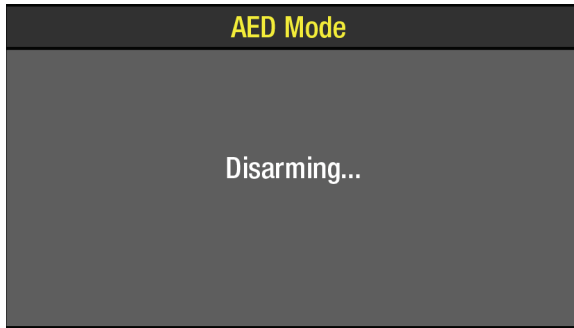

Note: If you do not press the ⚡ (shock) button within 60 seconds, or the **SPEED DIAL** is pressed to cancel charging, the defibrillator disarms and the **DISARMING** message appears.

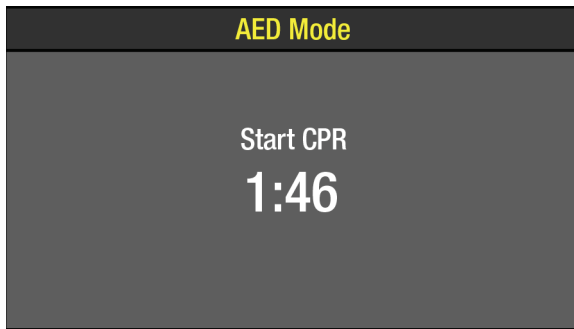

After a shock is delivered, the **START CPR** prompts occur. A countdown timer (min:sec format) continues for the duration specified in the **CPR TIME 1** setup option.

Note: The CPR metronome automatically provides audible compression “ticks” and ventilation prompts or tones only during CPR intervals at a ratio of 30:2. To silence the metronome, press **CPR**. To un-silence the metronome, press **CPR** again.

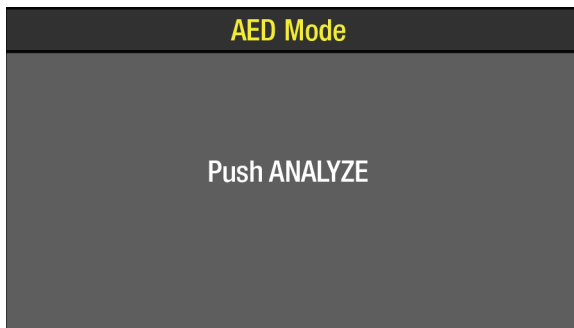

When the CPR countdown time ends, the **PUSH ANALYZE** prompts occur. These prompts repeat every 20 seconds until you press **ANALYZE**.

No Shock Advised

The following prompts occur if no shock is advised:

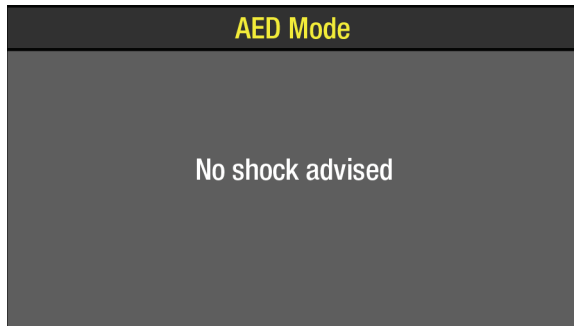

If the AED detects a nonshockable rhythm, the **NO SHOCK ADVISED** prompts occur. The defibrillator does not charge, and no shock can be delivered.

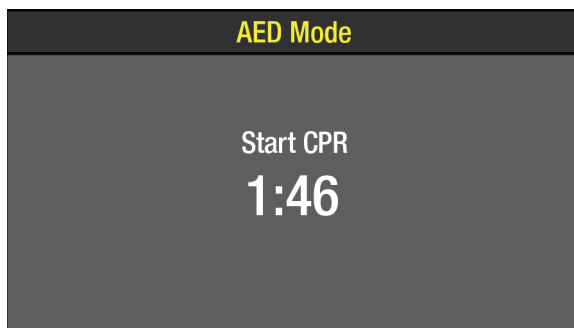

After **NO SHOCK ADVISED**, the **START CPR** prompts occur. A countdown timer (min:sec format) continues for the duration specified in the **CPR TIME 2** setup option.

Note: The CPR metronome automatically provides audible compression “tocks” and ventilation prompts or tones only during CPR intervals. To silence the metronome, press **CPR**. To un-silence the metronome, press **CPR** again.

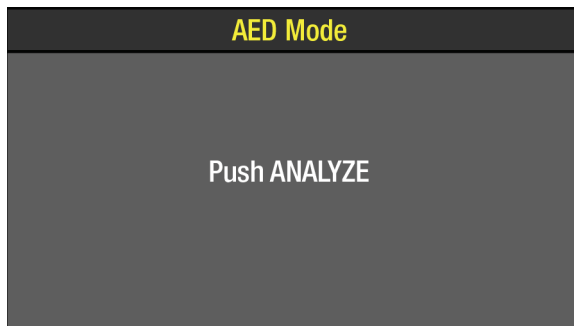

When the CPR countdown time ends, the **PUSH ANALYZE** prompts occur. These prompts repeat every 20 seconds until you press **ANALYZE**.

Subsequent analysis for **SHOCK ADVISED** and **NO SHOCK ADVISED** sequences are the same as described above. The energy level for Shock 2, 3, and greater depends on the **ENERGY PROTOCOL** setup and the analysis decision. When a **NO SHOCK ADVISED** decision follows a shock, the energy level does not increase for the next shock. When a **SHOCK ADVISED** decision follows a shock, the energy level increases for the next shock.

Motion Detected

If the AED detects motion during the ECG analysis, the **MOTION DETECTED, STOP MOTION** prompts occur, followed by a warning tone. Analysis is inhibited until the motion stops or for up to 10 seconds. After the motion ceases or 10 seconds have elapsed, analysis continues to completion even if motion is still present. For possible causes of motion detection and suggested solutions, see Troubleshooting Tips for AED Mode (on page 135).

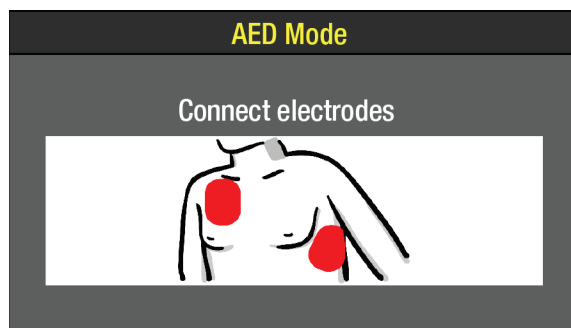
Electrodes or Therapy Cable Off

If therapy electrodes are not connected, the **CONNECT ELECTRODES** prompts occur until the patient is connected.

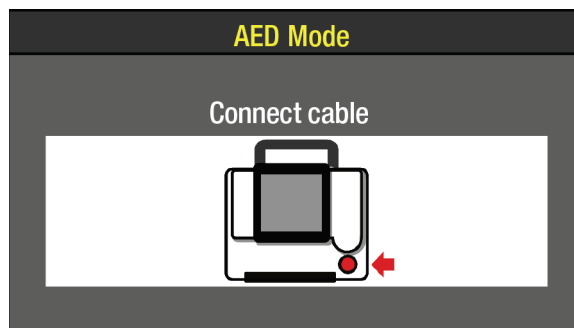

If the therapy cable is not connected to the defibrillator, the **CONNECT CABLE** message appears until the cable is connected.

Shock Counter

The shock counter ⚡ (x) indicates how many shocks have been delivered to the patient. The shock counter resets to zero whenever the defibrillator is turned off for longer than 30 seconds.

CPR Time and Metronome

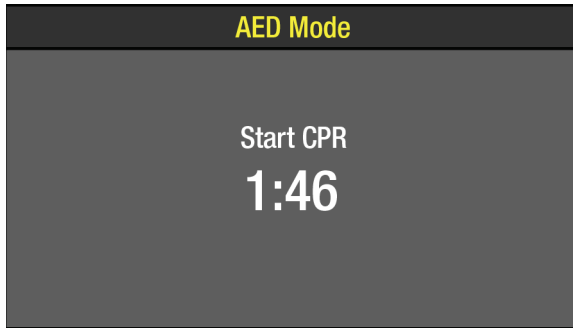

During use, CPR time shown on the countdown timer will vary slightly due to the metronome. When the CPR metronome is active during use, CPR times are adjusted to end CPR compression “ticks” on a compression cycle. As a result, the CPR countdown timer shows CPR times that approximate the seconds selected in Setup mode.

Even if the metronome is off or silent during CPR time, the CPR time displayed will vary slightly from the time set up in Setup mode. This is because the metronome keeps track of compression “ticks” and ventilation prompts in the background so that if the metronome is activated, the CPR time ends with compressions.

Switching from AED Mode to Manual Mode

When in AED mode, Manual mode may be accessed directly, require confirmation or a passcode, or not be accessible at all depending on how your defibrillator has been set up.

To switch from AED mode to Manual mode, press **ENERGY SELECT** one time. You can also press **PACER** or **CHARGE** to switch from AED mode to Manual mode.

Note: If the metronome is active (providing compression “ticks” and ventilation prompts) when you switch from AED mode to Manual mode, the metronome stays active upon entering Manual mode.

Depending on how manual access is set up, continue to Manual mode as follows:

- **AED/Direct**—No restrictions to Manual mode access.
- **AED/Confirmed**—A confirmation screen appears:

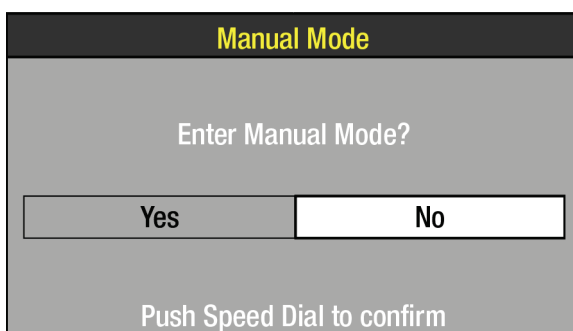

Select **YES** to enter Manual mode.

- **AED/Passcode**—A passcode screen appears:

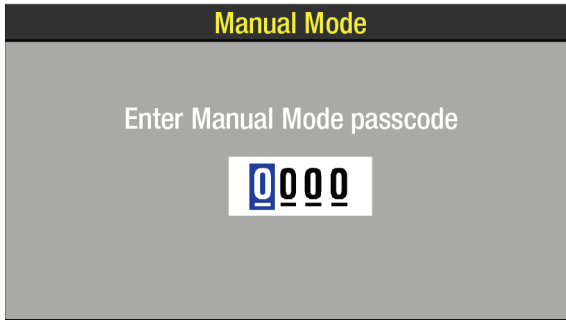

Rotate and press the **SPEED DIAL** to enter the passcode.

The code changes to dots to protect the passcode, and the defibrillator enters Manual mode.

You have three opportunities to enter the correct password. After an incorrect attempt, the message **INCORRECT--TRY AGAIN** appears. After three incorrect attempts, the message **ACCESS DENIED** appears, and the defibrillator returns to AED mode.

- **Restricted**—A **MANUAL MODE DISABLED** message appears, an alert tone sounds, and the LIFEPAK 15 monitor/defibrillator returns to AED mode.

It is important that all users of the LIFEPAK 15 monitor/defibrillator be thoroughly familiar with the monitor/defibrillator settings and operation before use.

Special AED Setup Options

The following descriptions of AED prompts (voice and text) explain special setup options.

Initial CPR - CPR First

When the **INITIAL CPR** option is set to **CPR FIRST**, you are prompted to **START CPR** immediately after the AED is turned on, and before an analysis.

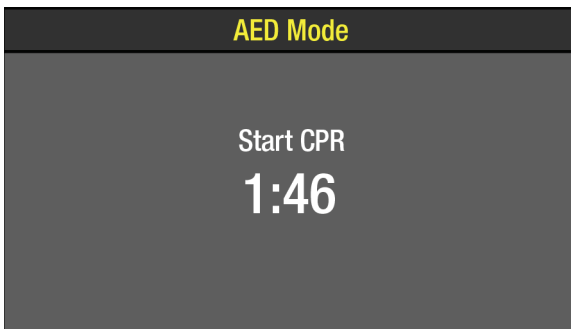

The **START CPR** prompts occur.

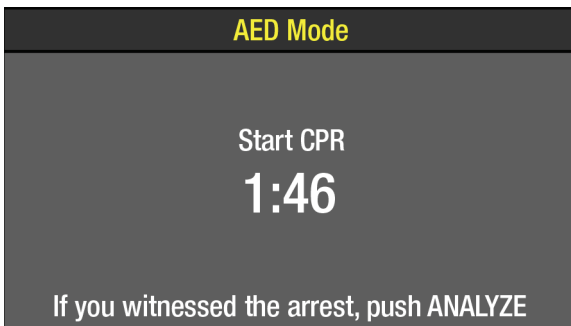

After 3 seconds, a countdown timer appears and the **IF YOU WITNESSED THE ARREST, PUSH ANALYZE** prompts occur. These prompts provide an opportunity to end the initial CPR early and proceed directly to analysis.

Note: The decision to end CPR early is based on your protocol and if you witnessed the arrest.

- If you did witness the arrest, press **ANALYZE**. The CPR period ends, and the **ANALYZING NOW, STAND CLEAR** prompts occur.
- If you did not witness the arrest, perform CPR and do not press **ANALYZE**. The Initial CPR countdown timer continues for the duration specified in the **INITIAL CPR TIME** setup option, for example, 90 seconds. When initial CPR time ends, the **PUSH ANALYZE** prompts occur.

Initial CPR - Analyze First

When the **INITIAL CPR** option is set to **ANALYZE FIRST**, you are prompted to perform analysis after the AED is turned on. CPR is prompted after the AED completes the analysis.

If the electrodes are not attached to the patient, the **CONNECT ELECTRODES** prompts occur before you are prompted to perform analysis.

No Shock Advised If the AED detects a nonshockable rhythm, the **START CPR** prompts occur.

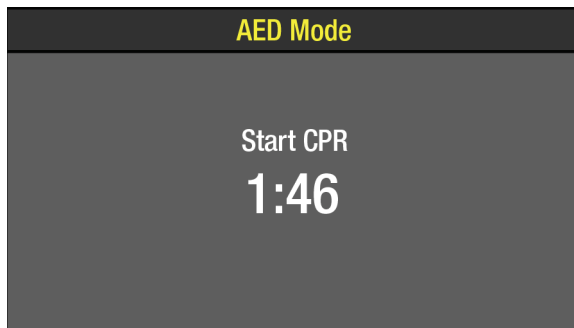

A countdown timer (min:sec format) continues for the duration specified in the **INITIAL CPR TIME** setup option.

When initial CPR time ends, the **NO SHOCK ADVISED** prompts occur, followed by **PUSH ANALYZE**.

Shock Advised If the AED detects a shockable rhythm, the **START CPR** prompts occur, followed by **IF YOU WITNESSED THE ARREST, PUSH ANALYZE**.

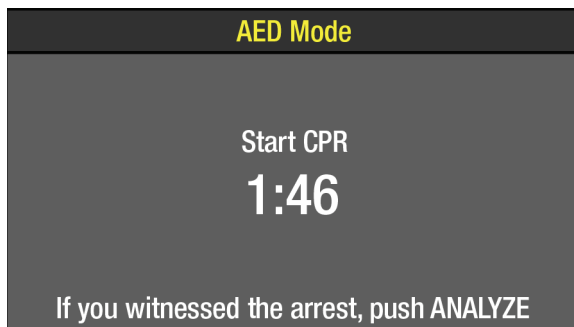

These prompts provide an opportunity to end the initial CPR early and proceed directly to delivering a shock.

Note: The decision to end CPR early is based on your protocol and if you witnessed the arrest.

- If you did witness the arrest, press **ANALYZE**. This ends the initial CPR period and the **SHOCK ADVISED** and **STAND CLEAR, PUSH SHOCK BUTTON! (⚡)** prompts occur. Proceed according to your training with the AED for delivering the shock.

- If you did not witness the arrest, perform CPR and do not press **ANALYZE** to end CPR early. The Initial CPR countdown timer continues for the duration specified in the **INITIAL CPR TIME** setup option, for example, 90 seconds. Near the end of CPR time, the defibrillator silently charges to prepare for the shock. CPR continues up to shock delivery. When initial CPR time ends, the **SHOCK ADVISED** and **STAND CLEAR, PUSH SHOCK BUTTON!** (⚡) prompts occur. Proceed according to your training with the AED for delivering a shock.

Pre-shock CPR Time

When **PRE-SHOCK CPR** time is set to 15 seconds or more, you are prompted to start CPR immediately after a shockable rhythm is detected, before the shock is delivered.

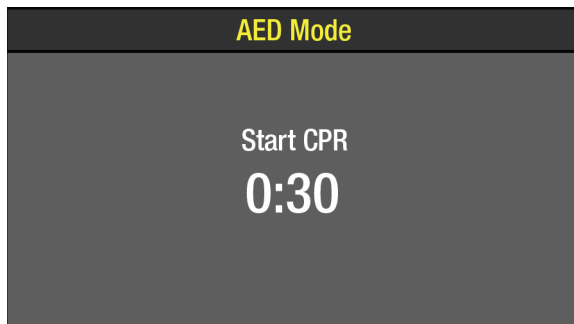

After analysis is complete, the **START CPR** prompts occur. A countdown timer (min:sec format) continues for the duration specified in the **PRE-SHOCK CPR** time setup option.

The defibrillator silently charges in preparation for the shock.

When CPR time ends, the **SHOCK ADVISED** and **STAND CLEAR, PUSH SHOCK BUTTON!** (⚡) prompts occur. Proceed according to your training with the AED for delivering a shock.

Note: The ⚡ (shock) button is disabled during the pre-shock CPR interval to avoid accidental shock delivery while the defibrillator is charged and a responder is performing CPR.

Advisory Monitoring

Advisory Monitoring is a special way to set up AED mode that allows the use of all the monitoring functions without initiating the AED prompted protocol when the device is turned on. When needed, the AED mode prompted protocol can be initiated by pressing **ANALYZE**. In addition, access to Manual mode therapies—that is, manual defibrillation, synchronized cardioversion, or pacing—by unauthorized users can be restricted, if necessary.

Certain setup options must be changed for the device to operate in Advisory Monitoring when it is turned on. For more information, see the *LIFEPAK 15 Monitor/Defibrillator Setup Options* provided with your device.

When set up for Advisory Monitoring and the monitor is turned on, the **ADVISORY MODE-MONITORING** message appears continuously in the message area on the Home Screen. Monitor functions such as NIBP, SpO₂ and 12-lead ECG can be used. Lead II and dashes are shown in the top ECG trace (Channel 1) unless or until the patient is connected to the ECG cable. If therapy electrodes (pads) and the therapy cable are connected to the patient, press **LEAD** to change to **PADDLES** lead and view the ECG.

In Advisory Monitoring, **LEAD II** and **PADDLES** lead are the only ECG monitoring leads allowed in Channel 1. The Continuous Patient Surveillance System (CPSS) is active and automatically evaluates the patient ECG. However, CPSS is evaluating only for a potentially

shockable rhythm. If a shockable ECG rhythm such as VF is detected, the following prompt appears: **CHECK PATIENT. IF NO PULSE, PUSH ANALYZE.**

Prior to pressing **ANALYZE**, confirm that the patient is in cardiac arrest. Motion artifact, a low amplitude ECG, and other causes of poor ECG signal may cause false CPSS alerts. If the patient is not in cardiac arrest, do not press **ANALYZE**. Troubleshoot the cause of the false CPSS alert.

If the patient is in cardiac arrest, press **ANALYZE**. Pressing **ANALYZE** causes the defibrillator to enter AED mode. The defibrillator begins the AED prompted protocol and analyzes the patient's ECG when therapy electrodes are applied to the patient. For more information about defibrillator behavior in AED mode, see Automated External Defibrillation (AED) (on page 123).

Note: CPSS only evaluates for shockable ECG rhythms. If the ECG rhythm is nonshockable, for example asystole, no prompting occurs. Users who are not trained to interpret ECGs or are trained only to use AED mode must always press **ANALYZE** when using this special setup function to initiate ECG analysis and AED prompting.

To switch back to Advisory Monitoring from AED prompted protocol, press **LEAD**.

For information about limiting access to Manual mode by unauthorized users, see Switching from AED Mode to Manual Mode (on page 130), or see the *LIFEPAK 15 Monitor/Defibrillator Setup Options* provided with your device.

Troubleshooting Tips

Table 21 Troubleshooting Tips for AED Mode

OBSERVATION	POSSIBLE CAUSE	CORRECTIVE ACTION
CONNECT ELECTRODES message appears	Therapy electrodes are not connected to the therapy cable	<ul style="list-style-type: none"> Check for electrode connection.
	Electrodes do not adhere properly to the patient	<ul style="list-style-type: none"> Press electrodes firmly on patient's skin. Clean, shave, and dry the patient's skin as recommended. Replace the electrodes.
	Electrodes are dry, damaged, or out of date	<ul style="list-style-type: none"> Apply new electrodes.
	Therapy cable damaged	<ul style="list-style-type: none"> Replace therapy cable and perform daily checks per Operator's Checklist.
CONNECT CABLE message appears	Therapy cable is disconnected during charging	<ul style="list-style-type: none"> Reconnect cable and press CHARGE again.
	Therapy cable damaged	<ul style="list-style-type: none"> Replace therapy cable and perform daily checks per Operator's Checklist.
MOTION DETECTED and STOP MOTION messages appear during analysis	Patient movement	<ul style="list-style-type: none"> Stop CPR during analysis. When patient is being manually ventilated, press ANALYZE after complete exhalation.
	Patient movement because of agonal respirations	<ul style="list-style-type: none"> Allow analysis to proceed to completion—analysis is delayed no more than 10 seconds due to motion detection.
	Electrical/radio frequency interference	<ul style="list-style-type: none"> Move hand-held communication devices or other suspected devices away from the defibrillator, when possible.
	Vehicle motion	<ul style="list-style-type: none"> Stop vehicle during analysis. Move patient to stable location, when possible.
DISARMING message appears (energy charge removed)	 (shock) button not pressed within 60 seconds after charge complete	<ul style="list-style-type: none"> Recharge the defibrillator, if desired.
	SPEED DIAL pressed	<ul style="list-style-type: none"> Recharge the defibrillator.
	Therapy electrodes or cable disconnected	<ul style="list-style-type: none"> Reconnect electrode or cable.

Manual Defibrillation

OBSERVATION	POSSIBLE CAUSE	CORRECTIVE ACTION
Energy did not escalate	After a shock, the next analysis was NO SHOCK ADVISED	<ul style="list-style-type: none"> No action needed. Defibrillator does not escalate energy when a NO SHOCK ADVISED decision follows a shock.
Charge time to 360 joules exceeds 10 seconds	Battery low	<ul style="list-style-type: none"> Replace battery with fully charged battery. Connect to auxiliary power using approved power adapter.
	Operating temperature is too low	<ul style="list-style-type: none"> Move patient and device to warmer environment, if necessary.
REPLACE BATTERY prompt occurs	Both batteries are very low	<ul style="list-style-type: none"> Replace one or both batteries immediately. Connect to auxiliary power using approved power adapter.
Voice prompts sound faint or distorted	Low battery power	<ul style="list-style-type: none"> Replace one or both batteries immediately. Connect to auxiliary power using approved power adapter.
CPR time shown (minutes/seconds) is different than expected	Function of metronome	<ul style="list-style-type: none"> None. The metronome adjusts the CPR time to ensure CPR cycle ends with compressions. (See CPR Time and Metronome (on page 130).)
	Incorrect setup option selected	<ul style="list-style-type: none"> Change CPR time setup option. See <i>LIFEPAK 15 Monitor/Defibrillator Setup Options</i> provided with your device.
Press CPR and metronome does not activate	In AED mode, and not in CPR interval	<ul style="list-style-type: none"> Wait until CPR interval (audible "tocks") to silence or activate metronome.
Home Screen is blank but ON LED is illuminated	Screen not functioning properly	<ul style="list-style-type: none"> Press ANALYZE and follow voice prompts to treat patient.
Analysis result is NO SHOCK ADVISED and ECG shows a perfectly flat, isoelectric line.	The Test Load is connected to therapy cable	<ul style="list-style-type: none"> Remove the Test Load and connect therapy electrodes to the cable.

For general troubleshooting tips, see General Troubleshooting Tips (on page 220).

Manual Defibrillation

The LIFEPAK 15 monitor/defibrillator provides manual defibrillation using adult and pediatric QUIK-COMBO pacing/defibrillation/ECG electrodes, adult standard paddles, or pediatric paddles. For more information, see Paddle Accessory Options (on page 155).

The LIFEPAK 15 monitor/defibrillator is capable of providing intra-operative direct defibrillation and synchronized cardioversion with the internal paddles accessory designed for the LIFEPAK 15 defibrillator. For more information, see the Instructions for Use for the internal paddles.

Intended Use

When used in Manual mode, the LIFEPAK 15 monitor/defibrillator is a direct current defibrillator that applies a brief, intense pulse of electricity to the heart muscle. Manual mode requires operator interpretation of the ECG rhythm and interaction with the device in order to defibrillate the patient.

Manual mode defibrillation and synchronized cardioversion are intended for use by personnel who are authorized by a physician or medical director and have, at a minimum, the following skills and training:

- Arrhythmia recognition and treatment
- Advanced resuscitation training equivalent to that recommended by the AHA or ERC
- Training on the use of the LIFEPAK 15 monitor/defibrillator

Defibrillation is only one aspect of the medical care required to resuscitate a patient who has a shockable ECG rhythm. Depending on the situation, other supportive measures may include:

- Cardiopulmonary resuscitation (CPR)
- Administration of supplemental oxygen
- Drug therapy

Indications

Manual defibrillation is indicated for the termination of certain potentially fatal arrhythmias, such as ventricular fibrillation and symptomatic ventricular tachycardia. Delivery of this energy in the synchronized mode is a method for treating atrial fibrillation, atrial flutter, paroxysmal supraventricular tachycardia and, in relatively stable patients, ventricular tachycardia.

Contraindications

Defibrillation is contraindicated in the treatment of Pulseless Electrical Activity (PEA), such as idioventricular or ventricular escape rhythms, and in the treatment of asystole.

Manual Defibrillation Warnings

WARNING

Shock Hazard

Conductive gel (wet or dry) on the paddle handles can allow the electrical energy to discharge through the operator during defibrillation. Completely clean the paddle electrode surfaces, handles, and storage area after defibrillation.

WARNING

Possible Fire, Burns, and Ineffective Energy Delivery

Precordial lead electrodes and lead wires may interfere with the placement of standard paddles or therapy electrodes. Before defibrillation, remove any interfering precordial lead electrodes and lead wires.

WARNING

Possible Burns and Ineffective Energy Delivery

A gel pathway on the skin between the standard paddles will cause defibrillating energy to arc between paddles and divert energy away from the heart muscle. Do not allow conductive gel (wet or dry) to become continuous between paddle sites.

WARNING

Possible Patient Skin Burns

During defibrillation, air pockets between the skin and standard paddles can cause patient skin burns. Completely cover paddle electrode surfaces with fresh conductive gel and apply 25 lb of pressure per paddle during discharge.

WARNING

Possible Paddle Damage and Patient Skin Burns

Discharging the defibrillator with the standard paddle surfaces shorted together can pit or damage the paddle electrode surface. Pitted or damaged paddle surfaces may cause patient skin burns during defibrillation. Discharge the defibrillator only as described in these operating instructions.

WARNING

Possible Incorrect Energy Delivery

The defibrillator does not automatically adjust energy when using pediatric therapy electrodes or pediatric standard paddles. Manually select the appropriate energy prior to defibrillating the patient.

WARNING**Possible Damage to Defibrillator and Defibrillator Shutdown**



When two defibrillators are used to deliver energy to the same patient at the same time, one or both defibrillators may be damaged and shutdown may occur. If the defibrillator shuts down, take the defibrillator out of service and contact qualified service personnel.

Manual Mode

The LIFEPAK 15 monitor/defibrillator is set up to operate in Manual mode when it is turned on (factory default setting). If required by your protocols, the defibrillator can be set up to power on in the automated external defibrillator (AED) mode. For information on switching from AED mode to Manual mode, see Switching from AED Mode to Manual Mode (on page 130).

Manual Defibrillation Procedure

To perform manual defibrillation:

1. Verify that the patient is in cardiopulmonary arrest (unconscious, pulseless, not breathing normally).
2. Press **ON**.
3. Identify the electrode or paddle sites on the patient and prepare the patient's skin. (See Patient Skin Preparation (on page 121).) Use either the anterior-lateral or anterior-posterior position.
4. Connect the therapy electrodes to the therapy cable and confirm cable connection to the defibrillator.
5. Apply therapy electrodes to the patient in anterior-lateral or anterior-posterior position. If using standard paddles, apply conductive gel to the paddles and place paddles on the patient's chest in the anterior-lateral position.
6. Confirm desired energy is selected, or press **ENERGY SELECT** or rotate the **SPEED DIAL** to select the desired energy. On the standard (hard) paddles, rotate the **ENERGY SELECT** dial.
7. Press **CHARGE**. While the defibrillator is charging, a charging bar appears and a ramping tone sounds, indicating the charging energy level. When the defibrillator is fully charged, the screen displays available energy.
8. Make certain all personnel, including the operator, stand clear of the patient, stretcher, bed, and any equipment connected to the patient.
9. Confirm ECG rhythm requires defibrillation. Confirm available energy.
10. Press the  (shock) button on the defibrillator or the  (shock) buttons on the standard paddles to discharge energy to the patient. For standard paddles, apply firm pressure with both paddles to the patient's chest, and press both paddle buttons simultaneously to discharge energy to the patient. For safety reasons, the  (shock) button on the defibrillator front panel is disabled when using standard paddles.

Note: To disarm (cancel the charge), press the **SPEED DIAL**. The defibrillator disarms automatically if shock buttons are not pressed within 60 seconds, or if you change the energy selection after charging begins.

Note: To interrupt defibrillation and initiate pacing, press **PACER**. If charged, the defibrillator disarms.
11. Start CPR according to your protocol. To activate the metronome, press **CPR** at any time.
12. At the end of your CPR period, observe the patient and the ECG rhythm. If an additional shock is necessary, repeat the procedure beginning at Step 6.

Successful resuscitation is related to the length of time between the onset of a heart rhythm that does not circulate blood (ventricular fibrillation, pulseless ventricular tachycardia) and defibrillation. The physiological state of the patient may affect the likelihood of successful defibrillation. Thus, failure to resuscitate a patient is not a reliable indicator of defibrillator performance. Patients often exhibit a muscular response (such as jumping or twitching) during an energy transfer. The absence of such a response is not a reliable indicator of actual energy delivery or device performance.

Using the CPR Metronome

When CPR is required during cardiac arrest, the CPR metronome provides audible prompts that guide the user to deliver CPR with proper timing in accordance with the 2015 American Heart Association and European Resuscitation Council CPR guidelines.

CPR Metronome Warnings

WARNING

CPR Delivered When Not Needed

The metronome sounds do not indicate information regarding the patient's condition. Because patient status can change in a short time, the patient should be assessed at all times. Do not perform CPR on a patient who is responsive or is breathing normally.

Note: The CPR metronome is a tool to be used as a timing aid during CPR. Assess the patient at all times and provide CPR only when indicated. Provide CPR according to your training and protocols.

How the CPR Metronome Works

The metronome provides audible "tocks" at a rate of 100/minute to guide the rescuer in performing chest compressions. The metronome also provides audible ventilation prompts (either a tone or verbal "ventilate") to cue the rescuer when to provide ventilations. The metronome prompts the rescuer to perform CPR at the selected compression to ventilation (C:V) ratio.

Age-Airway Considerations

The default C:V ratio for the metronome (in both AED and Manual modes) is Adult - No Airway (30:2) because most patients in cardiac arrest are adults who have an initially unsecured airway. In Manual mode, the user can choose the most appropriate C:V ratio based on the patient's age and current airway status. The Age-Airway selection determines the C:V ratio of the metronome sounds. The default C:V ratios are shown in the following table.

Table 22 Default Age-Airway C:V Ratios in Manual Mode

AGE-AIRWAY	C:V RATIO
Adult - No Airway*	30:2
Adult - Airway**	10:1
Youth - No Airway***	15:2
Youth - Airway	10:1

* No Airway = No artificial airway in place

** Airway = Advanced artificial airway in place

*** Youth = Pre-pubescent child

Note: The compression-to-ventilation ratio selections can be set up according to local medical protocols. For more information, see the *LIFEPAK 15 Monitor/Defibrillator Setup Options* provided with your device.

Activating and Deactivating the Metronome

To activate the CPR metronome in Manual mode:

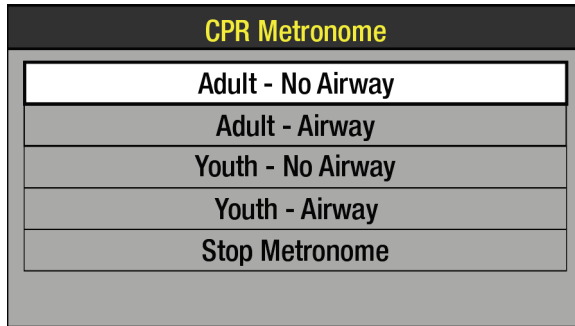

1. Press **CPR**. The CPR Metronome menu appears and the metronome is activated using the Adult-No Airway default setting.
2. Use the **SPEED DIAL** to highlight and select the desired Age-Airway setting.



When the metronome is on, a message appears in the message area that indicates the current Age-Airway selection.

Note: If the VF/VT alarm is on, it is suspended when the metronome is on to prevent false VF/VT alarms. If other vital sign alarms activate when the metronome is on, the visual indicators occur, but the alarm tone is suppressed until the metronome is deactivated.

The metronome provides "tocks" and ventilation prompts continuously until it is deactivated. To stop the metronome, select **STOP METRONOME** in the CPR Metronome menu. An event is recorded in the CODE SUMMARY Event Log when CPR metronome is turned ON or OFF and when the Age-Airway setting is changed. To adjust the volume of the metronome, press **OPTIONS**, select **ALARM VOLUME**, and change the **VOLUME**.

Note: If all Age-Airway selections are set to the same C:V ratio (for example, Adult - No Airway, Adult - Airway, Youth - No Airway, and Youth - Airway all set to 10:1), the CPR metronome always provides "tocks" and ventilation prompts at the set ratio for both AED mode and Manual mode. In this situation, the CPR Metronome menu does not appear when **CPR** is pressed during use—pressing the **CPR** button only activates and deactivates the metronome at the fixed C:V ratio.

Synchronized Cardioversion Procedure

The LIFEPAK 15 monitor/defibrillator can be set up to remain in Sync mode or to return to Asynchronous mode after a shock is delivered. The factory default setting is to return to Asynchronous mode after a shock. It is important that you know how your defibrillator is set up. For information about changing the setup option, see the *LIFEPAK 15 Monitor/Defibrillator Setup Options* provided with your device.

To perform synchronized cardioversion:

1. Press **ON**.
2. Attach patient ECG cable and ECG electrodes as previously described (see Monitoring the ECG (on page 49)). ECG electrodes and cable must be used to monitor the ECG when standard paddles are used for cardioversion.
3. Select Lead **II** or lead with greatest QRS complex amplitude (positive or negative).

Note: To monitor the ECG using therapy electrodes, place the electrodes in anterior-lateral position and select **PADDLES** lead.

WARNING



Possible Lethal Arrhythmia

Ventricular fibrillation may be induced with improper synchronization. **DO NOT** use the ECG from another monitor (slaving) to synchronize the monitor/defibrillator's discharge. Always monitor the patient's ECG directly through the defibrillator's ECG cable or therapy cable. Confirm proper placement of the sense markers on the ECG.

4. Press **SYNC**. The **SYNC MODE** message appears in the message area when Sync is active.

Note: Press **SYNC** again to deactivate Sync mode.
5. Observe the ECG rhythm. Confirm that a triangle sense marker (▼) appears near the middle of each QRS complex. If the sense markers do not appear or are displayed in the wrong locations (for example, on the T-wave), adjust **ECG SIZE** or select another lead. (It is normal for the sense marker location to vary slightly on each QRS complex.)
6. Connect the therapy electrodes to the therapy cable and confirm cable connection to the defibrillator.
7. Prepare the patient's skin and apply therapy electrodes to the patient in the anterior-lateral position. (See Therapy Electrode and Standard Paddle Placement (on page 121).) If using standard paddles, apply conductive gel to the paddles and place paddles on the patient's chest.
8. Press **ENERGY SELECT** or rotate the **SPEED DIAL** to select the desired energy. On the standard (hard) paddles, rotate the **ENERGY SELECT** dial.

Synchronized Cardioversion Procedure

9. Press **CHARGE**. While the defibrillator is charging, a charging bar appears and a ramping tone sounds, indicating the charging energy level. When the defibrillator is fully charged, the screen displays available energy.
10. Make certain all personnel, including the operator, stand clear of the patient, bed, stretcher, and any equipment connected to the patient.
11. Confirm ECG rhythm. Confirm available energy.
12. Press and *hold* the  (shock) button on the defibrillator until the **ENERGY DELIVERED** message appears on the screen. For standard paddles, press and hold both  (shock) buttons on the paddles simultaneously until the **ENERGY DELIVERED** message appears on the screen. Release buttons. For safety reasons, the  (shock) button on the defibrillator front panel is disabled when using standard paddles.

Note: To disarm (cancel a charge), press the **SPEED DIAL**. The defibrillator disarms automatically if shock buttons are not pressed within 60 seconds, or if you change the energy selection after charging begins.
13. Observe patient and ECG rhythm. Repeat procedure starting from Step 4, if necessary.

Troubleshooting Tips

Table 23 Troubleshooting Tips for Defibrillation and Synchronized Cardioversion

OBSERVATION	POSSIBLE CAUSE	CORRECTIVE ACTION
Charge time to 360 joules exceeds 10 seconds	Battery low	<ul style="list-style-type: none"> Replace battery with fully charged battery.
	Operating temperature is too low	<ul style="list-style-type: none"> Move patient and device to warmer environment, if necessary.
Energy not delivered to patient when ⚡ (shock) buttons are pressed	Device is in Sync mode and QRS complexes are not detected	<ul style="list-style-type: none"> Adjust ECG size for optimum sensing QRS or deactivate SYNC if rhythm VF/VT.
	SYNC accidentally pressed and rhythm is VF/VT	<ul style="list-style-type: none"> Press SYNC to turn off Sync. Press ⚡ (shock) buttons.
	Device in Sync mode and ⚡ (shock) buttons not pressed and held until next detected QRS	<ul style="list-style-type: none"> Hold ⚡ (shock) buttons until discharge occurs or next detected QRS and ENERGY DELIVERED message appears.
	⚡ (shock) buttons pressed before full charge reached	<ul style="list-style-type: none"> Wait for tone and message indicating full charge.
	Standard paddles connected and ⚡ (shock) button on defibrillator front panel pressed	<ul style="list-style-type: none"> Simultaneously press ⚡ (shock) buttons on standard paddles to discharge.
	Sixty seconds elapsed before ⚡ (shock) buttons were pressed after full charge. Energy was internally removed.	<ul style="list-style-type: none"> Press ⚡ (shock) buttons within 60 seconds of full charge.
CONNECT CABLE message appears	Energy selection changed	<ul style="list-style-type: none"> Press CHARGE again.
	Therapy cable disconnected during charging	<ul style="list-style-type: none"> Reconnect cable and press CHARGE again.
ENERGY FAULT message appears (selected and available energy)	Therapy cable damaged	<ul style="list-style-type: none"> Replace therapy cable and perform daily checks per Operator's Checklist.
	Defibrillator out of calibration	<ul style="list-style-type: none"> Attempt to transfer energy. Contact a qualified service technician.
DISARMING message appears	⚡ (shock) button not pressed within 60 seconds after charge complete	<ul style="list-style-type: none"> Recharge the defibrillator, if desired.
	Energy selected after charge complete	<ul style="list-style-type: none"> Recharge the defibrillator.
	SPEED DIAL pressed	<ul style="list-style-type: none"> Recharge the defibrillator.
	PACER pressed	<ul style="list-style-type: none"> Recharge, if necessary, or no action, if pacing desired.
	Therapy electrodes or cable disconnected	<ul style="list-style-type: none"> Reconnect electrode or cable.

Synchronized Cardioversion Procedure

OBSERVATION	POSSIBLE CAUSE	CORRECTIVE ACTION
Energy did not escalate automatically per energy protocol	ENERGY SELECT pressed and disabled automatic protocol	<ul style="list-style-type: none"> Continue to select energy manually to treat patient. For more information about energy protocol, see <i>LIFEPAK 15 Monitor/Defibrillator Setup Options</i> provided with your device.
SYNC mode will not activate	PACER is on. Pacing and Sync are separate functions and are not allowed at the same time.	<ul style="list-style-type: none"> Discontinue pacing, if appropriate for the patient, and press SYNC.
	ECG electrodes not attached to patient and standard paddles connected to defibrillator	<ul style="list-style-type: none"> Connect ECG electrodes to patient.
Patient did not "jump" (no muscle response) during defibrillator discharge	Patient muscle response is variable and depends on patient condition. Lack of visible response to defibrillation does not necessarily mean the discharge did not occur.	<ul style="list-style-type: none"> No action needed.
	The Test Load is connected to therapy cable	<ul style="list-style-type: none"> Remove the Test Load and connect therapy electrodes to cable.
ABNORMAL ENERGY DELIVERY message appears and Shock XJ Abnormal annotated on printout	Open air discharge with standard paddles	<ul style="list-style-type: none"> Press paddles firmly on patient's chest when discharging.
	Standard paddles placed face-to-face when ⚡ (shock) button pressed	<ul style="list-style-type: none"> Perform test discharges per Operator's Checklist. See Manual Defibrillation Warnings (on page 138).
	Patient impedance is out of range	<ul style="list-style-type: none"> Increase energy or repeat shocks as needed. Consider replacing disposable therapy electrodes with new ones.
	Internal fault occurred	<ul style="list-style-type: none"> Repeat shock. Perform CPR and obtain another defibrillator, if necessary.

OBSERVATION	POSSIBLE CAUSE	CORRECTIVE ACTION
CONNECT ELECTRODES message appears	Therapy electrodes are not connected to the therapy cable	<ul style="list-style-type: none"> • Check for electrode connection.
	Electrodes do not adhere properly to the patient	<ul style="list-style-type: none"> • Press electrodes firmly on patient's skin. • Clean, shave, and dry the patient's skin as recommended. • Apply new electrodes.
	Electrodes are dry, damaged, or out of date	<ul style="list-style-type: none"> • Apply new electrodes.
	Therapy cable damaged	<ul style="list-style-type: none"> • Replace therapy cable and perform daily checks per Operator's Checklist.
REPLACE BATTERY prompt occurs	Both batteries are very low	<ul style="list-style-type: none"> • Replace one or both batteries immediately. • Connect to auxiliary power using approved power adapter.
CPR time shown (minutes/seconds) is different than expected	Metronome is on	<ul style="list-style-type: none"> • None. The metronome adjusts the CPR time to ensure CPR cycle ends with compressions.
	Incorrect setup option selected	<ul style="list-style-type: none"> • Change CPR time setup option. See <i>LIFEPAK 15 Monitor/Defibrillator Setup Options</i> provided with your device.
Home Screen is blank but ON LED is illuminated	Screen not functioning properly	<ul style="list-style-type: none"> • Print ECG strip to assess rhythm and other active vital signs. • Press ANALYZE and use AED mode, if necessary.

For general troubleshooting tips, see General Troubleshooting Tips (on page 220).

Noninvasive Pacing

The LIFEPAK 15 monitor/defibrillator provides noninvasive pacing using adult or pediatric QUIK-COMBO pacing/defibrillation/ECG electrodes. For more information, see Paddle Accessory Options (on page 155).

Intended Use

A noninvasive pacemaker is a device that delivers an electrical stimulus to the heart causing cardiac depolarization and myocardial contraction. The energy is delivered through large adhesive electrodes placed on the chest. In addition to noninvasive pacing, other supportive measures may be necessary.

Noninvasive pacing is intended for use by personnel who are authorized by a physician or medical director and have, at a minimum, the following skills and training:

- Arrhythmia recognition and treatment
- Advanced resuscitation training equivalent to that recommended by the AHA or ERC
- Training on the use of the LIFEPAK 15 monitor/defibrillator

Indications

Noninvasive pacing is indicated for symptomatic bradycardia in patients with a pulse.

Contraindications

Noninvasive pacing is contraindicated for the treatment of ventricular fibrillation and asystole.

Noninvasive Pacing Warnings

WARNING

Possible Inability to Pace

Using other manufacturers' combination therapy electrodes with this device could cause a decrease in pacing efficacy or the inability to pace because of unacceptably high impedance levels and invalidate the safety agency certifications. Use only the therapy electrodes that are specified in these operating instructions.

Demand and Nondemand Pacing

The LIFEPAK 15 monitor/defibrillator can be used for either demand or nondemand (asynchronous or "fixed rate") pacing.

Demand mode is used for most patients. In demand mode, the LIFEPAK 15 pacemaker inhibits pacing output when it "senses" the patient's own beats (intrinsic QRSs). In demand mode, if the ECG SIZE is set too low to detect the patient's beats, or if an ECG lead becomes detached so that the ECG rhythm is not present, the pacemaker generates pacing pulses asynchronously. This means that the pacemaker generates pacing pulses at the selected rate regardless of the patient's ECG rhythm.

Nondemand mode can be selected if noise or artifact interferes with proper sensing of QRS complexes. Press **OPTIONS** to access nondemand mode. For more information, see Options (on page 43).

Noninvasive Pacing Procedure

ECG monitoring during pacing is performed with the ECG electrodes and patient ECG cable. Therapy electrodes are not capable of monitoring ECG and delivering pacing current at the same time.

Be sure to place the QUIK-COMBO therapy electrodes in the proper locations. Improper placement of the electrodes may make a difference in the capture threshold. For example, if the electrode placement is reversed, more pacing current may be needed to achieve capture.

WARNING**Possible Interruption of Therapy**

Observe the patient continuously while the pacemaker is in use. Patient response to pacing therapy (for example, capture threshold) may change over time.

To perform noninvasive pacing:

1. Press **ON**.
2. Connect the patient ECG cable, apply ECG electrodes to the ECG cable and patient, and select Lead **I**, **II**, or **III**. To receive the best monitoring signal, make sure there is adequate space between the ECG electrodes and the therapy electrodes.
3. Identify the QUIK-COMBO therapy electrode sites on the patient. Use either the anterior-lateral or anterior-posterior position and prepare the patient's skin. (See Therapy Electrode and Standard Paddle Placement (on page 121).)
4. Apply therapy electrodes to the patient.
5. Connect the therapy electrodes to the therapy cable.
6. Press **PACER**.

WARNING**Possible Ineffective Pacing**

The ECG size must be properly adjusted so that the patient's own beats are detected. If ECG size is set too high or too low, pacing pulses may not be delivered when required. Adjust ECG size so that sense markers are placed on the patient's QRS complexes.

-
7. Observe the ECG rhythm. Confirm that a triangle sense marker (▼) appears near the middle of each QRS complex. If the sense markers do not appear or are displayed in the wrong location (for example, on the T-wave), adjust **ECG SIZE**, or select another lead. (The sense marker location may vary slightly on each QRS complex.)
 8. Press **RATE** or rotate the **SPEED DIAL** to select the desired pacing rate.
 9. Press **CURRENT** or rotate the **SPEED DIAL** to increase current until electrical capture occurs. Electrical capture is indicated by a wide QRS complex and a T-wave following the pace marker. For each delivered pacing stimulus, a positive pace marker displays on the ECG waveform.

Note: Dashes (---), not heart rate, are displayed on the Home Screen during noninvasive pacing, and heart rate alarms are disabled.

10. Palpate patient's pulse or check blood pressure to assess for mechanical capture. Consider use of sedation or analgesia if patient is uncomfortable.

Note: To change rate or current during pacing, press **RATE** or **CURRENT**. The **RATE** and **CURRENT** buttons allow changes in increments of 10; the **SPEED DIAL** allows changes in increments of 5.

Note: To interrupt pacing and view the patient's intrinsic rhythm, press and hold **PAUSE**. This causes the pacer to pace at 25% of the set rate. Release **PAUSE** to resume pacing at the set rate.

11. To stop pacing, reduce current to zero or press **PACER**.

Note: To defibrillate and stop noninvasive pacing, press **CHARGE**. Pacing automatically stops. Proceed with defibrillation.

The physiologic state of the patient may affect the likelihood of successful pacing or of skeletal muscle activity. The failure to successfully pace a patient is not a reliable indicator of pacemaker performance. Similarly, the patient's muscular response to pacing is not a reliable indicator of current delivered.

WARNING**Possible Patient Skin Burns**

Prolonged noninvasive pacing may cause patient skin irritation and burns, especially with higher pacing current levels. Discontinue noninvasive pacing if skin becomes burned and another method of pacing is available. For additional information about therapy electrodes, see QUIK-COMBO Therapy Electrodes (on page 157).

If the monitor detects **ECG LEADS OFF** during pacing, pacing automatically switches to nondemand and continues at a fixed rate until the ECG lead is reattached. During nondemand pacing, the pacemaker delivers pulses at the set pace rate regardless of any intrinsic beats that the patient may have. The monitor continues to display the pacing rate (ppm) and the current (mA). To reestablish demand pacing, reattach the ECG lead.

While pacing, visually monitor the patient at all times—*do not* rely on the **ECG LEADS OFF** warning to detect changes in pacing function. Routinely assess for proper ECG sensing, pace pulse delivery, electrical capture, and mechanical capture.

If pacing electrodes detach during pacing, you see **CONNECT ELECTRODES** and **PACING STOPPED** messages and hear an alarm. The pacing rate is maintained and the current resets to 0 mA. Reattaching the pacing electrodes silences the alarm and removes the **CONNECT ELECTRODES** message. The current remains at 0 mA until you increase the current manually.

To turn off the LIFEPAK 15 monitor/defibrillator, pacing must be stopped. If the **ON** button is pressed when **PACER** is active, an alert tone sounds and the **PACING IN PROGRESS** message appears.

Troubleshooting Tips

Table 24 Troubleshooting Tips for Noninvasive Pacing

OBSERVATION	POSSIBLE CAUSE	CORRECTIVE ACTION
Device does not function when PACER is pressed	Power off	<ul style="list-style-type: none"> • Check if power is ON.
	Low battery	<ul style="list-style-type: none"> • Replace battery with fully charged battery.
PACER LED is on, but CURRENT (mA) will not increase	Therapy electrodes off	<ul style="list-style-type: none"> • Check for message displayed. • Inspect therapy cable and electrode connections.
PACER LED on, CURRENT (mA) >0, but pace markers absent (not pacing)	Pacing rate set below patient's intrinsic rate	<ul style="list-style-type: none"> • Increase PPM.
	Pacer oversensing (ECG artifact, ECG size too high)	<ul style="list-style-type: none"> • Establish clean ECG; decrease ECG size. • Select nondemand pacing.
Monitor screen displays distortion while pacing	ECG electrodes not optimally placed with respect to pacing electrodes	<ul style="list-style-type: none"> • Reposition electrodes away from pacing electrodes. • Select another lead (I, II, or III).
Pacing stops spontaneously	PACER pressed off	<ul style="list-style-type: none"> • Press PACER and increase the current.
	Internal error detected. Service message indicates an internal failure.	<ul style="list-style-type: none"> • Check for service indicator. • Cycle power and start pacing again. • Obtain service by a qualified service technician.
	Therapy electrode off	<ul style="list-style-type: none"> • Check for message. Check pacing cable and electrode connections.
	CHARGE pressed	<ul style="list-style-type: none"> • Press PACER and increase current, if pacing desired. Otherwise, proceed with defibrillation.
	Radio frequency interference	<ul style="list-style-type: none"> • Move radio equipment away from pacemaker.
No muscle response to pacing	Patient's heart rate may be greater than noninvasive pacer ppm	<ul style="list-style-type: none"> • No action needed.
	The Test Load is connected to therapy cable	<ul style="list-style-type: none"> • Remove the Test Load and connect therapy electrodes to cable.
	Patient muscle response is variable and depends on patient condition. Muscular response to pacing is not a reliable indicator of current delivered.	<ul style="list-style-type: none"> • No action needed.
Capture does not occur with pacing stimulus	Current (mA) set too low	<ul style="list-style-type: none"> • Increase pacing current. (Administer sedation or analgesia as needed.)

OBSERVATION	POSSIBLE CAUSE	CORRECTIVE ACTION
CONNECT CABLE or PACING STOPPED message appears	Therapy cable damaged	<ul style="list-style-type: none"> Replace therapy cable and perform daily checks per Operator's Checklist.
CONNECT ELECTRODES message appears	Pacing cable or electrode disconnected	<ul style="list-style-type: none"> Reconnect and set current.
	Electrodes not adhering to skin	<ul style="list-style-type: none"> Prepare skin.
	Therapy cable damaged	<ul style="list-style-type: none"> Replace therapy cable and perform daily checks per Operator's Checklist.
	Electrodes outdated	<ul style="list-style-type: none"> Replace electrodes and set current.
PACING IN PROGRESS message appears	CPR pressed	<ul style="list-style-type: none"> Press PACER to stop pacing, if appropriate, and then press CPR.
Pacing stops spontaneously and PACER FAULT message appears	Internal error detected	<ul style="list-style-type: none"> Cycle power and start pacing again. Obtain service by a qualified service technician.
Intrinsic QRS complexes not sensed when pacing	ECG size too low	<ul style="list-style-type: none"> Increase ECG size or select another lead.
	Intrinsic QRS complexes are occurring during pacemaker's refractory period	<ul style="list-style-type: none"> Adjust PPM.
Pacing starts spontaneously	Patient's heart rate falls below set pacing rate	<ul style="list-style-type: none"> Appropriate pacemaker function; assess patient.
	During standby pacing, ECG lead disconnects and pacing begins asynchronously	<ul style="list-style-type: none"> Reconnect ECG lead.
Set pacing rate (ppm) and ECG paced rate do not appear to match	Internal error detected	<ul style="list-style-type: none"> Print ECG and calculate the pace rate.
Improper sensing (for example, sensing on T-waves)	QRS complex too small	<ul style="list-style-type: none"> Select another lead.
	T-wave too large	<ul style="list-style-type: none"> Adjust ECG size.
SYNC mode will not activate	PACER is on. Pacing and Sync are separate functions and are not allowed at the same time.	<ul style="list-style-type: none"> Discontinue pacing, if appropriate for the patient, and press SYNC.
Defibrillator will not turn off	Pacemaker is on	<ul style="list-style-type: none"> Turn off PACER and then press and hold ON for at least 2 seconds.

For general troubleshooting tips, see General Troubleshooting Tips (on page 220).

Pediatric ECG Monitoring and Manual Mode Therapy Procedures

WARNING

Possible Patient Skin Burns

Do not use pediatric QUIK-COMBO electrodes on adults or larger children. Delivery of defibrillation energies equal to or greater than 100 joules (typically used on adults) through these smaller electrodes increases the possibility of skin burns.

WARNING

Possible Pediatric Patient Skin Burns

Noninvasive pacing may cause patient skin irritation and burns, especially with higher pacing current levels. Inspect underlying skin of the ♥ electrode frequently after 30 minutes of continuous pacing. Discontinue noninvasive pacing if skin burn develops and another method of pacing is available. On cessation of pacing, immediately remove or replace electrodes with new ones.

For pediatric patients, follow the procedures for ECG monitoring, manual defibrillation, synchronized cardioversion, and pacing except for the following:

- Use the appropriate paddle accessory based on the weight of the child.
- Select the appropriate defibrillation energy for the weight of the child according to the American Heart Association (AHA) recommendations or local protocol. Using energy levels of 100 joules or greater is likely to cause burns.
- When pacing, inspect the patient's skin under the heart electrode frequently for signs of burns.

Note: For more information about pediatric paddles and electrodes, see Paddle Accessory Options (on page 155).

Paddle Accessory Options

This chapter provides information about the paddle accessory options that may be used with the LIFEPAK 15 monitor/defibrillator.

QUIK-COMBO Therapy Electrodes.....	157
Standard Paddles.....	160
Sterilizable Internal Defibrillation Paddles.....	164

QUIK-COMBO Therapy Electrodes

Physio-Control QUIK-COMBO therapy electrodes are pre-gelled, self-adhesive therapy electrodes used for defibrillation, synchronized cardioversion, ECG monitoring, and pacing.

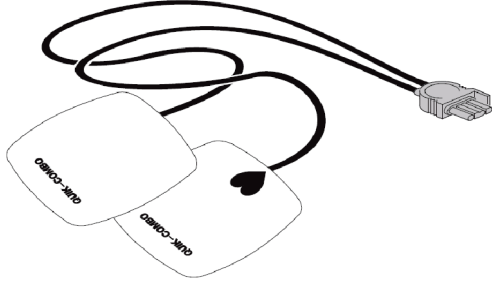

Figure 35 QUIK-COMBO Therapy Electrodes

A QUIK-COMBO therapy electrode set:

- Is a substitute for standard paddles.
- Provides Lead II monitoring signal when placed in the anterior-lateral position.
- Quickly restores the ECG trace on the monitor following defibrillation.

Always have immediate access to a spare set of therapy electrodes.

To help prevent therapy electrode damage:

- Only open electrode package immediately prior to use.
- Slowly peel back the protective liner on the electrodes, beginning with the cable connection end.
- Do not trim therapy electrodes.
- Do not crush, fold, or store the electrodes under heavy objects.
- Store therapy electrodes in a location where temperatures are between 15° and 35°C (59° and 95°F). Continuous exposure to the higher temperatures within this range will shorten the life of the electrodes.

Several types of QUIK-COMBO therapy electrodes are available as described in Table, QUIK-COMBO Electrodes (on page 158).

IMPORTANT! Infant/Child Reduced Energy Defibrillation Electrodes are not compatible with the LIFEPAK 15 monitor/defibrillator.

Table 25 QUIK-COMBO Electrodes

TYPE	DESCRIPTION
QUIK-COMBO	Electrodes, with 61 cm (2 ft) of lead wire, designed for patients weighing 15 kg (33 lb) or more
QUIK-COMBO RTS	Electrodes, providing a radio-transparent electrode and lead wire set, designed for patients weighing 15 kg (33 lb) or more
QUIK-COMBO with REDI-PAK® preconnect system	Electrodes designed for patients weighing 15 kg (33 lb) or more and that allow preconnection of the electrode set to the device while maintaining electrode shelf life and integrity
Pediatric QUIK-COMBO RTS	Electrodes designed for patients weighing 15 kg (33 lb) or less

Connecting Therapy Electrodes

To connect QUIK-COMBO therapy electrodes to the QUIK-COMBO therapy cable:

1. Open the protective cover on the therapy cable connector (see the following figure).
2. To insert the QUIK-COMBO electrode connector into the therapy cable connector, align the arrows and press the connectors firmly together.

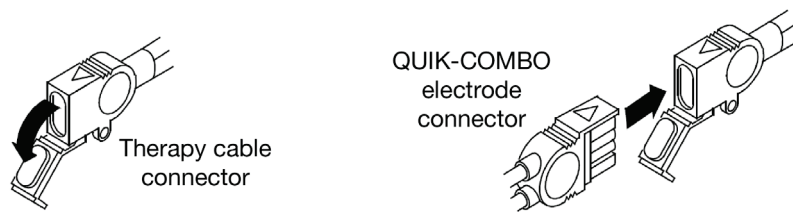

Figure 36 Connect QUIK-COMBO Electrodes to Therapy Cable

Replacing and Removing Therapy Electrodes

Replace adult QUIK-COMBO electrodes with new electrodes after one of the following occurs:

- 50 defibrillation shocks
- 24 hours on the patient's skin
- 8 hours of continuous pacing

Replace pediatric QUIK-COMBO electrodes with new electrodes after one of the following occurs:

- 25 defibrillation shocks
- 24 hours on the patient's skin
- 8 hours of continuous pacing

To remove QUIK-COMBO therapy electrodes from the patient:

1. Slowly peel back the therapy electrode from the edge, supporting the skin as shown.

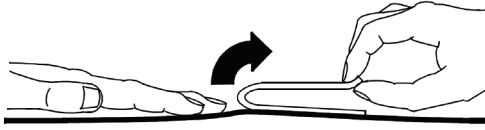

Figure 37 Removing Therapy Electrodes from Skin

2. Clean and dry the patient's skin.
3. When applying new electrodes, adjust the positions slightly to help prevent skin burns.
4. Close the protective cover on the therapy cable connector when the cable is not in use.

Cleaning and Inspection

QUIK-COMBO electrodes are not sterile or sterilizable. They are disposable and are for a single patient application. Do not autoclave, gas sterilize, immerse in fluids, or clean electrodes with alcohol or solvents.

Include daily inspection of the QUIK-COMBO therapy electrode package as part of your defibrillator test routine. Daily inspection helps ensure that the therapy electrode has not exceeded the electrode package Use By date and is ready for use when needed. For more information about daily inspection and testing, see the Operator's Checklist in the back of this manual.

Standard Paddles

Adult Standard Paddles

Standard paddles are hard, hand-held paddles that are applied to the patient's chest to briefly monitor the ECG or to deliver defibrillation shocks. The following figure describes the features of the standard paddles.

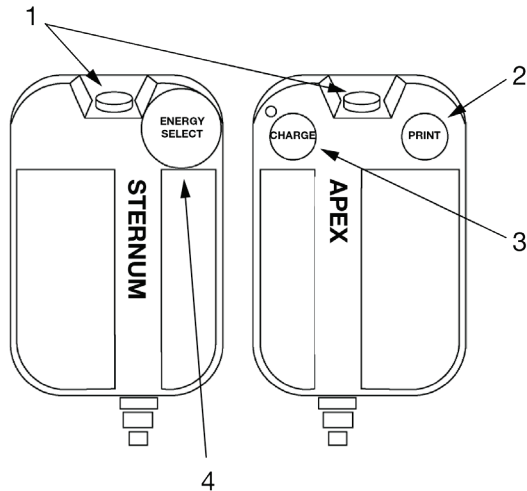



Figure 38 Standard Paddles

FIGURE LEGEND

- 1  (Shock) buttons. Discharge the defibrillator. Both buttons must be pressed simultaneously to deliver energy.
- 2 **PRINT** button. Activates printer. Function is identical to **PRINT** button on front panel.
- 3 **CHARGE** button. Charges the defibrillator. Adjacent **CHARGE** indicator flashes when device is charging and glows steadily when fully charged.
- 4 **ENERGY SELECT** dial. Rotary dial changes energy levels displayed on the screen.

A standard paddle set:

- Can be used instead of QUIK-COMBO therapy electrodes.
- Provides Lead II monitoring signal when held in the anterior-lateral position.
- Is used for defibrillation, synchronized cardioversion, and QUIK-LOOK® ECG checks.

To help prevent standard paddles damage:

- Handle with care to prevent damage to paddle surfaces.
- Store in paddle wells on the device to protect the electrode surface.
- Clean dried or wet gel from the electrode surface after each use.

Cleaning and Inspecting Standard Paddles

After each use:

1. Wipe standard paddle electrodes, handles, paddle wells, cables, and connector with mild disinfectant or soap and water solution. Do not immerse or soak.
2. Dry thoroughly.
3. Examine paddle surfaces, handles, cables, and connectors for damage or signs of wear.
 - Cables that show signs of wear such as loose cable connections, exposed wires, or cable connector corrosion must be removed from use immediately.
 - Paddles that have rough or pitted electrodes should be removed from use immediately.

Note: Standard paddles are not sterile or sterilizable. Do not autoclave, gas sterilize, immerse in fluids, or clean with alcohol or solvents.

Testing Standard Paddles

Include inspecting and testing of the standard paddles as part of your defibrillator test routine. Daily inspection and testing helps ensure that the standard paddles are in good operating condition and are ready for use when needed. For more information about inspection and testing, see the Operator's Checklist in the back of this manual.

Pediatric Paddles

Pediatric paddles slide onto adult paddles. Pediatric paddles should be used for patients weighing less than 10 kg (22 lb) or for patients whose chest size cannot accommodate the adult hard paddles.

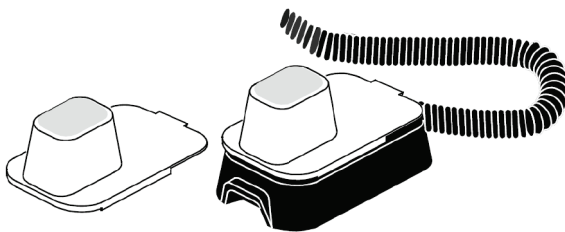

Figure 39 Pediatric Paddles

Use the adult paddle controls for selecting energy and charging. Each pediatric paddle attachment has a metal spring plate with a contact on it that transfers defibrillation energy from the adult paddle electrode to the pediatric paddle. This solid cadmium-silver contact will not scratch the adult paddle electrode.

Note: Inspect the spring plates and the contacts routinely to make sure that they are clean and intact.

Attaching Pediatric Paddles

To attach the pediatric paddles:

1. Slide the paddles onto clean adult paddles, starting at the front of the adult paddle (see following figure).
2. Slide the pediatric paddle until you feel the paddles lock in place.

Note: Do not use conductive gel *between* adult and pediatric paddles.

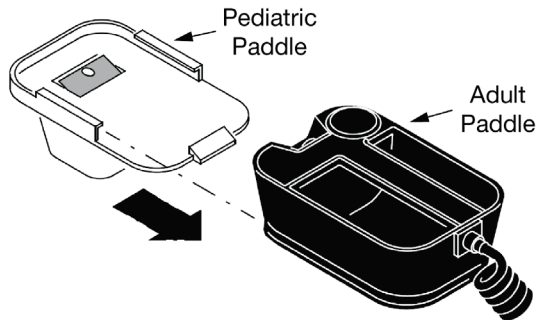

Figure 40 Attaching a Pediatric Paddle

Removing Pediatric Paddles

To remove pediatric paddles:

1. Press down on the rear tab.
2. Slide the pediatric paddle off.

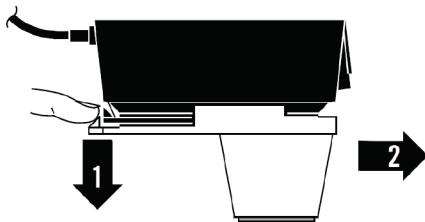

Figure 41 Removing a Pediatric Paddle

Placing Pediatric Paddles

Adult paddles are recommended if the paddles fit completely on the child's chest. Allow at least 2.5 cm (1 in.) of space between the paddles.

For infants with very small chests, pediatric paddles may be too large to place in the anterior-lateral position. In this situation, place paddles in the anterior-posterior position. Holding the paddles against the chest and back supports the patient on his or her side.

Do not use the pediatric paddles on adults or older children. Delivery of recommended adult energies through this relatively small electrode surface increases the possibility of skin burns.

Anterior-Lateral Placement. Standard pediatric paddle placement includes (see following figure):

- **STERNUM** paddle to the patient’s right upper torso, lateral to the sternum and below the clavicle.
- **APEX** paddle lateral to the patient’s left nipple in the midaxillary line, with the center of the paddle in the midaxillary line, if possible.

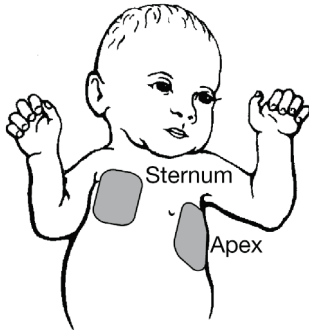

Figure 42 Anterior-Lateral Paddle Position

Anterior-Posterior Placement. Place the **APEX** paddle anteriorly over the left precordium and the **STERNUM** paddle posteriorly behind the heart in the infrascapular area (see following figure).

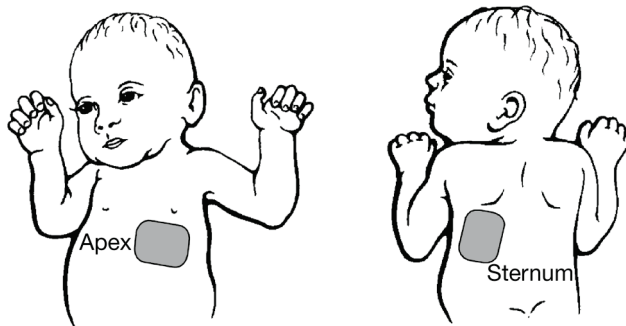

Figure 43 Anterior-Posterior Paddle Position

Cleaning and Inspecting Pediatric Paddles

Individually protect paddles before and after cleaning to prevent damage to paddle surfaces. After each use:

1. Wipe or rinse paddle electrodes, cable connector, paddle handles, and cables with mild soap and water or disinfectant using a damp sponge, towel, or brush. Do not immerse or soak.
2. Dry thoroughly.
3. Examine paddle surfaces, connector, handles, and cables for damage or signs of wear.
 - Cables that show signs of wear such as loose cable connections, exposed wires, or cable connector corrosion should be removed from use immediately.
 - Paddles that have rough or pitted electrodes should be removed from use immediately.

Sterilizable Internal Defibrillation Paddles

Physio-Control internal paddles are specifically designed for open chest cardiac defibrillation.

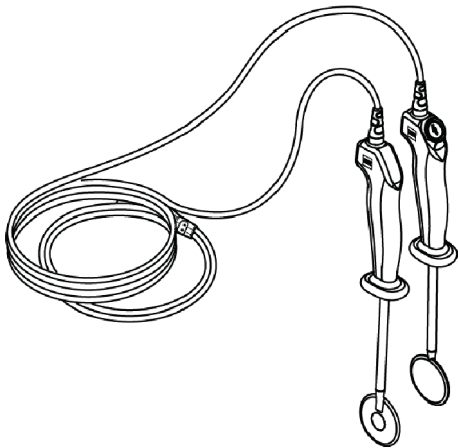

Figure 44 Sterilizable Internal Defibrillation Paddles

Internal paddles are available in several sizes. To order internal paddles, contact your Physio-Control representative. In the USA, call Customer Support at 1.800.442.1142, option 2.

For complete information about using internal paddles to provide open chest cardiac defibrillation, see the *Instructions for Use* provided with the internal paddles.

Data Management

This chapter describes how to manage current and archived Patient Records when using the LIFEPAK 15 monitor/defibrillator.

Patient Records and Reports	167
Memory Capacity	173
Managing Current Patient Records.....	173
Managing Archived Patient Records.....	175

Patient Records and Reports

When you turn on the LIFEPAK 15 monitor/defibrillator, a new Patient Record is created and stamped with the current date and time. All events and associated waveforms are digitally stored in the Patient Record as reports, which you can print, transmit, or download to the LIFENET® System, or to post-event review products such as CODE-STAT™ or DT EXPRESS™ software. For information on how to print a report, see How to Print a Current Report (on page 173). For information on how to transmit or download a report, see Data Transmission (on page 179). When you turn off the device, the current Patient Record is saved in the archives.

You can also print, transmit, download, or delete any Patient Records that are stored in the archives. To access the archives, press **OPTIONS** and then select **ARCHIVES**. When you enter Archive mode, patient monitoring ends and the current Patient Record is saved and closed. Turn off the device to exit Archive mode. For more information, see Managing Archived Patient Records (on page 175).

Report Types

The reports that are available in a Patient Record depend on the features in your device and how your device is set up. For information on setting up your device, see the *LIFEPAK 15 Monitor/Defibrillator Setup Options* provided with your device. The following table describes the various report types that may exist in a Patient Record and how they can be accessed.

Table 26 Report Types

REPORT TYPE	DESCRIPTION	PRINT FROM MONITOR	TRANSMIT
12-Lead ECG Report	The diagnostic 12-lead ECG report. For more information, see Printed 12-Lead ECG Report Formats (on page 66).	X	X ¹
CODE SUMMARY™ Critical Event Record	Includes patient information, event and vital sign log, and waveforms associated with events (for example, defibrillation). For more information, see CODE SUMMARY Report (on page 168).	X	X
Vital Signs Summary	Includes patient information and event and vital sign log.	X	X
Trend Summary	Includes patient information, vital sign log, and vital sign graphs.	X	X
Snapshot Report	Includes patient information and 8 seconds of waveform data captured at the time of transmission.		X
Continuous Report ²	Provides real-time waveform data, acquired when the device is powered on and electrodes are connected or other waveform data is displayed in channels 2 or 3. Only for post-event review with CODE-STAT or DT EXPRESS software.		X

¹ Transmission of a 12-lead ECG report automatically includes transmission of the Vital Signs Summary.

² To obtain CPR analytics using CODE-STAT software, therapy electrodes must be connected to the patient.

Note: All reports that are transmitted to the LIFENET System include the following information:

- Battery status
- Power adapter status
- Device usage information
- Manufacturing configuration settings
- 3:00 A.M. self-test results

CODE SUMMARY Report

The LIFEPAK 15 monitor/defibrillator automatically stores a CODE SUMMARY report as part of the Patient Record for each patient. The CODE SUMMARY report can be set up to always print in a particular format. The available formats are shown in the following table. For CODE SUMMARY setup information, see the *LIFEPAK 15 Monitor/Defibrillator Setup Options* provided with your device.

To generate a CODE SUMMARY report, press **CODE SUMMARY**. If you interrupt printing of a CODE SUMMARY report, the entire CODE SUMMARY report is reprinted when printing is resumed. "Code Summary Complete" prints immediately following the last waveform event.

Table 27 CODE SUMMARY Formats

FORMAT	ATTRIBUTES
Long format	<ul style="list-style-type: none"> • Preamble • Event/vital sign log • Event waveforms • 12-lead ECG reports • Trend Summary
Medium format	<ul style="list-style-type: none"> • Preamble • Event/vital sign log • Event waveforms • Trend Summary
Short format	<ul style="list-style-type: none"> • Preamble • Event/vital sign log • Trend Summary

Note: When CODE SUMMARY reports are transmitted, they are always sent in the long format. Transmitted CODE SUMMARY reports do not include the Trend Summary.

The CODE SUMMARY report always contains the Preamble and the Event/Vital Sign Log. See the following figure for an example.

1		2									
Name: Lee, William		Time	Event	HR	SpO2-PR	SpCO	SpMet	EtCO2(mmHg)-RR	NIBP-PR	P1	P2
Record ID:	041495094322	07:15:34	Power On								
Patient ID:	528760004	07:18:24	Initial Rhythm	95	99-95		38-12				
Incident:	BF382	07:20:34	Vital Signs	96	98-96	2	.4	37-12			
Age: 50	Sex: M	07:20:55									
CODE SUMMARY™		07:22:20	NIBP	99	99-99	2	.4	37-11	138/72(93)-99		
critical event record		07:23:31	Pacing 1 Started	95	98-95	2	.4	38-12		138/70(92)	24/15(19)
		07:24:36	Pacing 2 Set	93	99-93	2	.4	37-10		138/70(92)	24/15(19)
Power On:	24 Apr 13 08:03:12	07:25:10	Intubation	100	98-100	2	.4	34-8		128/68(80)	22/15(18)
Device:	010	07:25:34	Vital Signs	96	98-96	2	.4	37-12		138/70(92)	24/15(19)
Site:	123	07:27:04	Pacing 3 Stopped	91	98-91	2	.4	37-12		138/70(92)	24/15(19)
Total Shocks:	3	07:29:20	Alarm HR	161	98-161	2	.4	38-11		138/70(93)	24/15(19)
Total Time Paced:	00:15:00	07:30:34	Vital Signs	96	98-95	2	.4	37-12		138/70(92)	24/15(19)
Total 12-leads:	6	07:31:00									CVP
Elapsed Time:	00:52:43	07:31:18	CPR: No Airway 30:2	88	97-88	2	.4	37-15		130/81(105)	7
COMMENTS:		07:32:22	Metronome Off	--	96--	2	.4	34--		98/66(80)	8
		07:33:11	Shock 1 200J	--	96--	2	.4	34--		98/66(80)	8
		07:33:59	Shock 2 200J	--	96--	2	.4	34--		98/66(80)	8
		07:35:11	Shock 3 360J	--	96--	2	.4	34--		98/66(80)	9
		07:35:34		35	98-35	2	.4	37-4		108/70(92)	9
35:1 0005HDKFIEJSJG LP1586837694											

Figure 45 CODE SUMMARY Report

FIGURE LEGEND

- 1 Preamble
- 2 Event/Vital Sign Log

Preamble

The preamble consists of patient information (name, patient ID, age, and sex) and device information (date, time, and therapy information) as shown in the preceding figure. The defibrillator automatically enters a unique identifier in the ID field for each Patient Record. This identifier is composed of the date and time that the defibrillator is turned on. The Incident field allows you to enter up to 14 alpha-numeric characters to link the device to other documents such as an EMS Run Report.

Event/Vital Sign Log

The LIFEPAK 15 monitor/defibrillator documents events and vital signs in chronological order. Events are operator or device actions, such as actions that are related to monitoring, pacing, AED therapy, or data transmission. Values for each active vital sign are entered into the log automatically every 5 minutes and for each event. The following table lists events that may be found in the Event Log.

Table 28 Possible Event Log Entries

<p>Monitoring</p> <ul style="list-style-type: none"> • Check patient • Initial rhythm • Replace battery • 12-lead • NIBP • Alarm events • IP label change • Vital signs • 5-wire on/off • SpCO/SpMet Advisory <p>AED</p> <ul style="list-style-type: none"> • Connect electrodes • Motion • Analysis • Analysis stopped • Shock advised • No shock advised <p>CPR Metronome</p> <ul style="list-style-type: none"> • On/Off • Age-Airway changed <p>Defibrillation</p> <ul style="list-style-type: none"> • Manual mode • Charge removed • Shock X, XXXJ • Shock X, Abnormal 	<p>Operator Initiated</p> <ul style="list-style-type: none"> • Event • Alarms on/off • Print • VF/VT alarm on/off • Sync on/off • Snapshot • Internal pacer detection on/off <p>Pacing</p> <ul style="list-style-type: none"> • Started • Set • Changed • Stopped • Paused <p>Transmission</p> <ul style="list-style-type: none"> • Transmission complete • Transmission failed • Transmission cancelled <p>Memory Status</p> <ul style="list-style-type: none"> • Out of waveform memory (memory low) • Out of event memory (memory full)
--	---

Waveform Events

In addition to being documented in the Event Log, therapy and other selected events also capture waveform data that are printed with the long and medium CODE SUMMARY report. The waveform events and the characteristics of waveform data are described in the following table.

Table 29 Waveform Events

EVENT NAME	WAVEFORM DATA (WHEN CAPTURED)
INITIAL RHYTHM	8 seconds after leads on
CHECK PATIENT	8 seconds prior to alert
SHOCK or NO SHOCK ADVISED	2-3 segments of analyzed ECG. Each segment is 2.7 seconds
ANALYSIS X STOPPED	8 seconds of data prior to cessation of analysis
SHOCK X	3 seconds prior to shock and 5 seconds after shock
PACING X STARTED	8 seconds prior to increase of current from 0
PACING X SET	8 seconds after ppm and mA are stable for 10 seconds
PACING X CHANGED	8 seconds after pacing rate, current, or mode is changed
PACING X STOPPED	3 seconds prior to pacing current is zero and 5 seconds after

EVENT NAME	WAVEFORM DATA (WHEN CAPTURED)
PACING X PAUSED	Initial 8 seconds while PAUSE is pressed
ALARM*	3 seconds prior to violated parameter and 5 seconds after
EVENT*	3 seconds prior to event selection and 5 seconds after
PRINT	3 seconds prior to pressing PRINT and 5 seconds after
12-LEAD	10 seconds after 12-LEAD is pressed
SNAPSHOT	3 seconds prior to and 5 seconds after SNAPSHOT requested
VITAL SIGNS	3 seconds prior to and 5 seconds after vital signs are acquired

*To reduce the length of the CODE SUMMARY report, storing waveform data with these events can be set to OFF (see the *LIFEPAK 15 Monitor/Defibrillator Setup Options* provided with your device).

Waveform events are preceded by a header that includes the following information:

- Patient data
- Event name
- Therapy data*
- Vital signs
- Device configuration information

*Patient impedance (in ohms) appears on shock reports when using disposable defibrillation electrodes. This impedance is measured just prior to the shock and is used to determine voltage compensation.

The following figures show four examples of waveform events as they would appear in the CODE SUMMARY report.

Analysis Event

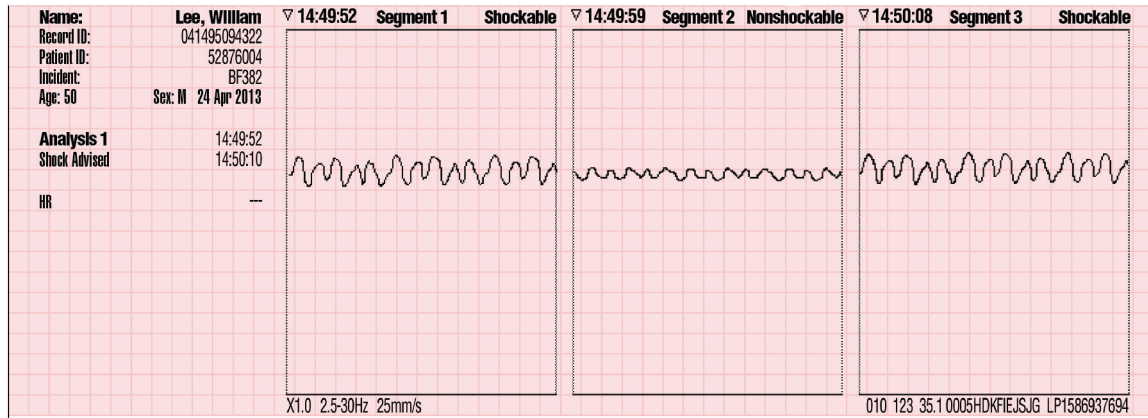

Shock Event

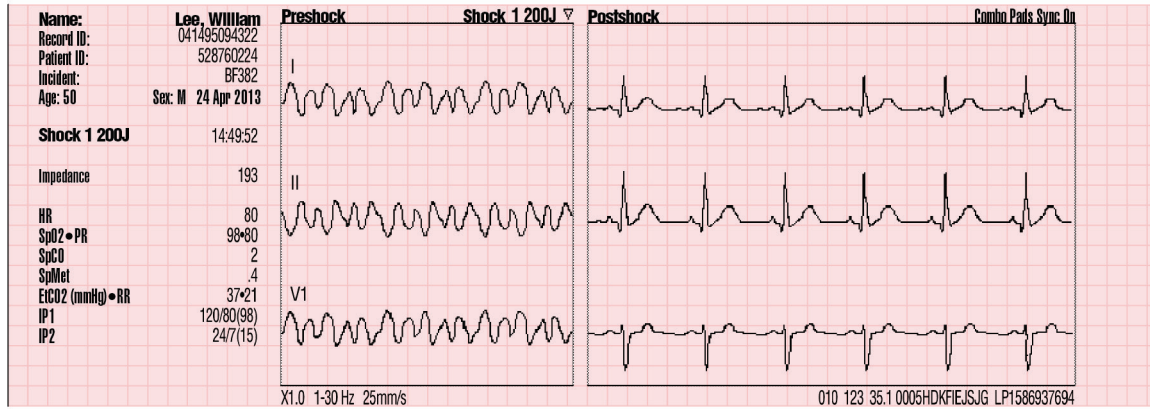

Check Patient Event

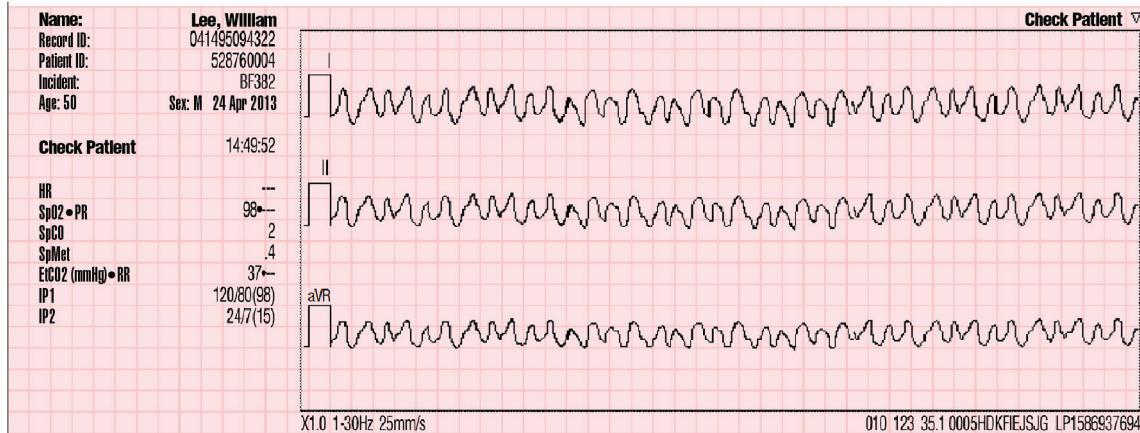

Pacing Event



Figure 46 Waveform Event Printout Examples

Memory Capacity

The LIFEPAK 15 monitor/defibrillator retains data for two or more patients when you switch power off or remove the batteries. The number of patient reports that the LIFEPAK 15 monitor/defibrillator can store depends on various factors, including the number of displayed waveforms, the duration of each use, and the type of therapy. The total capacity is 360 minutes of continuous ECG, 90 minutes of continuous data from all channels, or 400 single waveform events. The maximum memory capacity for a single patient includes up to 200 single waveform reports and 90 minutes of continuous ECG. When the defibrillator reaches the limits of its memory capacity, the defibrillator deletes an entire Patient Record using a "first in, first out" priority to accommodate a new Patient Record. Deleted Patient Records cannot be retrieved.

Managing Current Patient Records

You can add specific patient information to a current Patient Record. For more information, see Entering Patient Data (on page 44).

How to Print a Current Report

To print a current report:

Options	
Patient...	Archives...
Pacing...	Print...
Date/Time...	User Test
Alarm Volume...	

- 1 Press **OPTIONS**. The Options menu appears.
- 2 Select **PRINT**. The Options/Print menu appears.

Options / Print	
Print	
Report	Code Summary
Format	3-Channel
Mode	Monitor
Speed	25mm/sec

3 If the **REPORT**, **FORMAT**, and **MODE** settings are correct, select **PRINT**. Otherwise, make changes as desired.

Select a **REPORT**:

- **CODE SUMMARY**
- **TREND SUMMARY**
- **VITAL SIGNS**
- **12-LEAD**

Note: A check next to a 12-lead report indicates that the report was previously printed.

Select a **FORMAT** (for 12-Lead ECG only):

- **3-CHANNEL**
- **4-CHANNEL**

Select a **MODE** to change the frequency response of ECG reports:

- **MONITOR**
- **DIAGNOSTIC** (12-Lead reports always print in Diagnostic mode)

Select the **SPEED** option on this menu to change the speed of the continuous printout when the **PRINT** button is pressed. Note that this **SPEED** option does not affect reports that are printed from this menu. Available printing speeds for the **PRINT** button are:

- **12.5 mm/sec**
- **25 mm/sec**

Managing Archived Patient Records

When you turn off the LIFEPAK 15 monitor/defibrillator, the current Patient Record is saved in the archives. You can print, edit, delete, or download archived records. For information about downloading to CODE-STAT software, see Data Transmission (on page 179). You can also transmit individual reports from an archived Patient Record. For information about transmitting an archived report, see Data Transmission (on page 179).

Note: When you enter Archive mode, patient monitoring ends (for example, no ECG, no alarms) and the current Patient Record is saved and closed.

Accessing Archive Mode

To enter Archive mode:

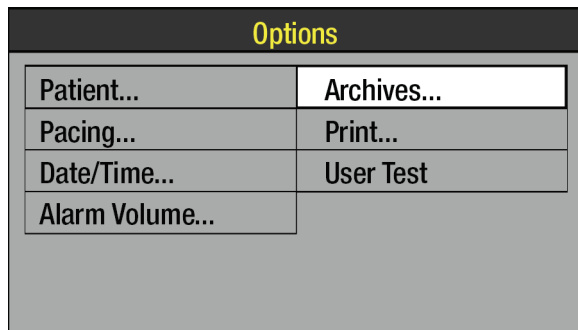

- 1 Press **OPTIONS**. The Options menu appears.
- 2 Select **ARCHIVES**. The Options/Archives menu appears.

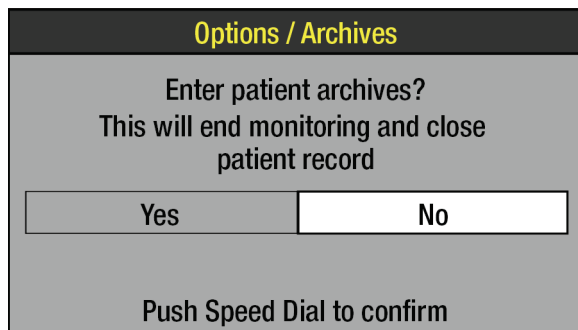

- 3 Select **YES**. The device enters Archive mode and the Options/Archives menu appears.
Note: Your device may be set up so that you must enter a password to enter Archive mode.

Note: To exit Archive mode, power off the device.

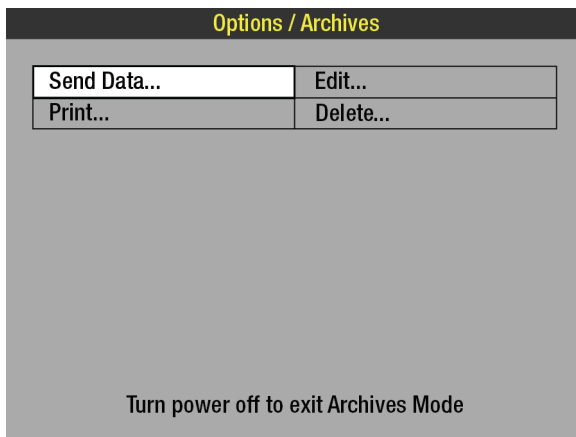

You can send, print, edit, or delete an archived record. For information about sending an archived record, see Data Transmission (on page 179).

Printing Archived Patient Reports

To print archived patient reports:

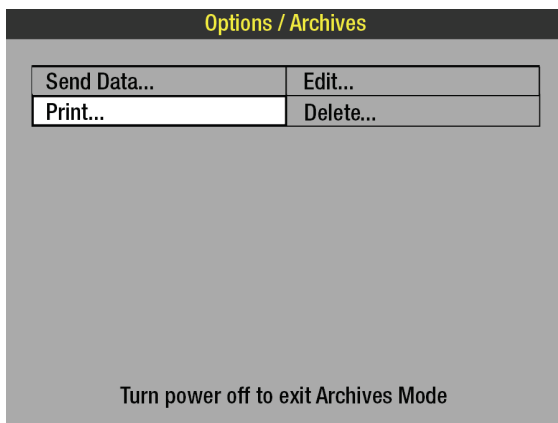

- 1 In Archive mode, select **PRINT**. The Options/ Archives/Print menu appears showing the current patient.

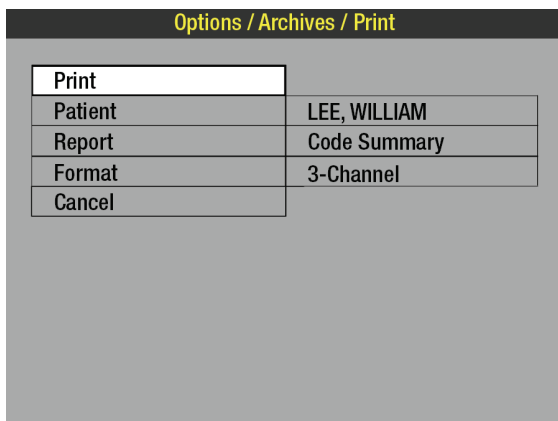

- 2 If the **PATIENT**, **REPORT**, and **FORMAT** settings are correct, go to Step 6.
- 3 To select a different patient, select **PATIENT** and then select the desired patient from the list.
- 4 To select a different report, select **REPORT** and then select one of the following:
 - **CODE SUMMARY**
 - **TREND SUMMARY**
 - **VITAL SIGNS**
 - **12-LEAD**
- 5 To select a different format, select **FORMAT** and then select one of the following (for 12-Lead ECG only):
 - **3-CHANNEL**
 - **4-CHANNEL**
- 6 Select **PRINT**. The archived report is printed.

Editing Archived Patient Records

To edit archived patient records:

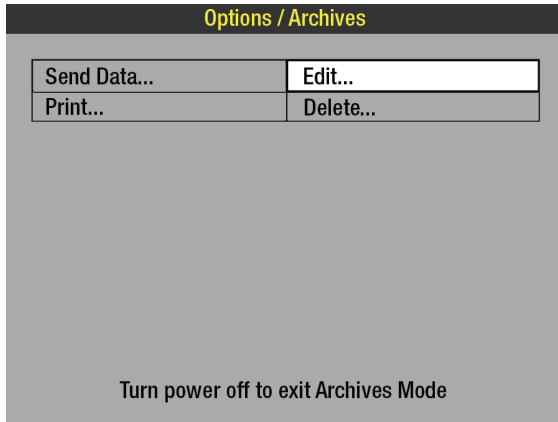

- 1 In Archive mode, select **EDIT**. The Options/Archives/Edit menu appears.

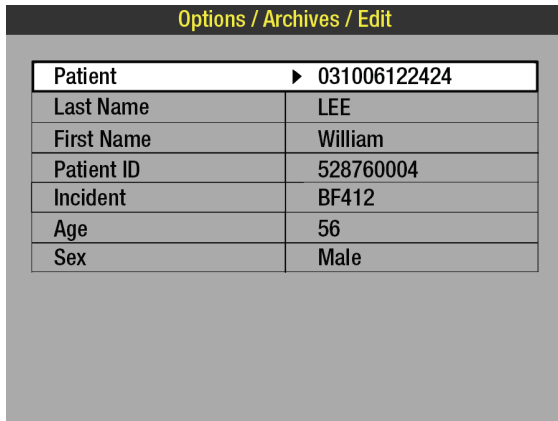

- 2 Select **PATIENT**.
- 3 Add the necessary patient information. Only blank fields may be edited.
- 4 Press **HOME SCREEN** and then turn off the device.

Deleting Archived Patient Records

To delete archived patient records:

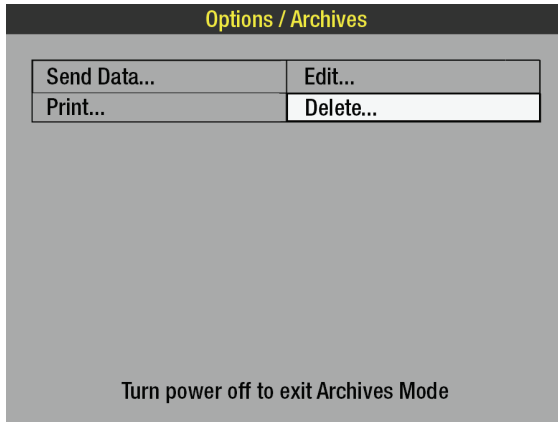

- 1 In Archive mode, select **DELETE**. The Options/Archives/Delete menu appears.

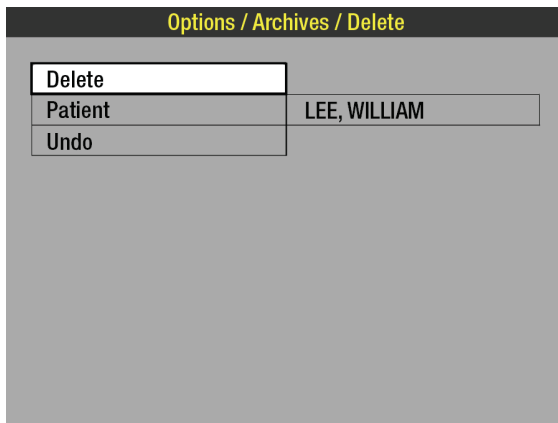

- 2 To permanently remove the Patient Record that is displayed, select **DELETE**.
- 3 To see the list of all patient records, select **PATIENT**. The patient list appears. Select the Patient Record you want to delete.
- 4 To undo the delete operation, immediately select **UNDO**. If you continue with other device operations, you cannot undo the deletion.
- 5 Press **HOME SCREEN** and then turn off the device.

Data Transmission

This chapter describes how to transmit Patient Records and reports from the LIFEPAK 15 monitor/defibrillator.

About Transmitting Patient Records and Reports	181
Preparing the Monitor for Transmission.....	182
Using Bluetooth Wireless Communication	182
Using a Direct Connection	187
Transmitting Reports	189
Considerations When Transmitting Data	191
Troubleshooting Tips.....	192

About Transmitting Patient Records and Reports

You can transmit current and archived data from the LIFEPAK 15 monitor/defibrillator to the LIFENET® System or to post-event review products such as CODE-STAT™ or DT EXPRESS™ software.

The LIFEPAK 15 monitor can transmit patient reports using the following methods:

- *Bluetooth*® wireless connection—If your LIFEPAK 15 monitor has the *Bluetooth* feature installed and enabled, you can transmit data using a wireless connection.
- Direct cable connection—You can use a special cable to establish a direct connection from the LIFEPAK 15 monitor to a PC or gateway, and transmit data using this wired connection.

The following figure represents an overview of the data transmission process.

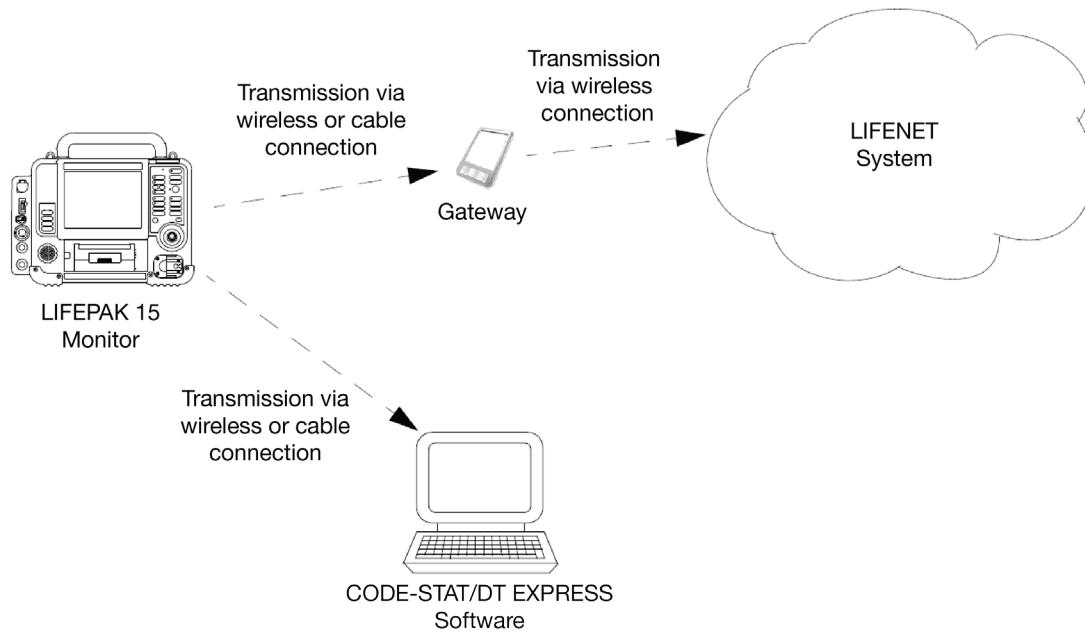

Figure 47 Transmitting Data from the LIFEPAK 15 Monitor/Defibrillator

For information about configuring your LIFEPAK 15 monitor to work in the LIFENET System, see the LIFENET System help documentation or contact your Physio-Control representative.

Preparing the Monitor for Transmission

Before you can transmit using a wireless or direct connection, you must define transmission sites and output ports in the LIFEPAK 15 monitor Setup mode.

For each transmission site, select an output port:

- For wireless transmission, set **OUTPUT PORT** to **BLUETOOTH WIRELESS**.
- For a direct connection, set **OUTPUT PORT** to **DIRECT CONNECT**.
- Set **OUTPUT PORT** to **BOTH** if you normally transmit using a *Bluetooth* connection but you need a direct cable backup. (If you set **OUTPUT PORT** to **BOTH**, make sure the *Bluetooth* LED is not illuminated before you attempt to transmit using a direct connection. The device will not transmit using the direct connection when a wireless connection is available.)

For more information, see the *LIFEPAK 15 Monitor/Defibrillator Setup Options* provided with your device.

Using Bluetooth Wireless Communication

Bluetooth technology is a short-range wireless communication technology that is available as an option on the LIFEPAK 15 monitor/defibrillator. When *Bluetooth* technology is installed, the *Bluetooth* icon appears on the Home Screen. See Figure, Bluetooth Icon on the Home Screen (on page 183).

See the *Bluetooth* label in battery well 2 for FCC and Industry Canada radio identification numbers.

A *Bluetooth* connection between the LIFEPAK 15 monitor and a target device is always initiated from the LIFEPAK 15 monitor.

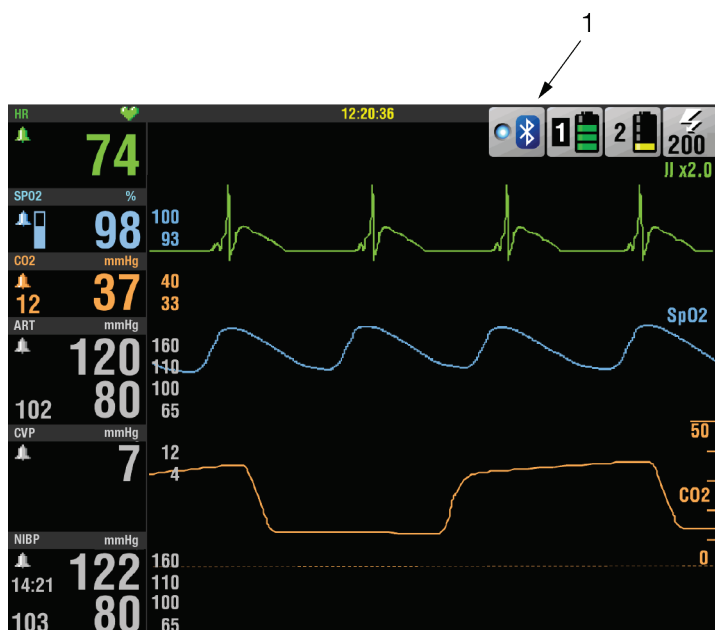

Figure 48 *Bluetooth* Icon on the Home Screen

FIGURE LEGEND

- 1 Bluetooth icon

The *Bluetooth* icon shows the status of the wireless connectivity in the device.

Bluetooth Passcodes

The LIFEPAK 15 monitor has a *Bluetooth* passcode that you define.

To transmit from the LIFEPAK 15 monitor to a headless gateway (a device that has no user interface), the *Bluetooth* passcode that you enter in the LIFEPAK 15 monitor must match the *Bluetooth* passcode that is preconfigured in the gateway. For information about the *Bluetooth* passcode in the headless gateway, see the documentation that ships with the gateway, or consult your system administrator or equipment technician.

To transmit from the LIFEPAK 15 monitor to a PC, you need to set a *Bluetooth* passcode in the LIFEPAK 15 monitor, and then enter that passcode on the PC, if prompted.

Bluetooth Search Filter

A *Bluetooth*-enabled LIFEPAK 15 monitor may discover numerous *Bluetooth* devices that are within range. To help filter out extraneous devices and find the specific target device that you want to transmit to, Physio-Control developed the Physio Service Class (PSC).

The PSC is a prefix that you can add to the friendly name of your target devices. Then when you set the **SEARCH FILTER** to **ON** in the LIFEPAK 15 monitor, only target devices that have the PSC

prefix in their names appear in the list of discovered devices (if they are powered on and discoverable).

The various PSC prefixes correspond to LIFEPAK 15 monitor modes of operation. The following table lists the LIFEPAK 15 monitor modes and the service class and friendly name prefix that is discoverable in each mode. For example, when the LIFEPAK 15 monitor is in Archive mode and the filter is on, it can discover devices whose friendly names begin with A_ or B_.

Table 30 Physio Service Class Prefixes

LIFEPAK 15 MONITOR/DEFIBRILLATOR MODE	SERVICE CLASS	FRIENDLY NAME PREFIX
LIFEPAK 15 monitor must be in Archive mode	Archive	A_
LIFEPAK 15 monitor can be in AED, Manual, or Archive mode	Both Cardiac Care and Archive	B_
LIFEPAK 15 monitor can be in AED or Manual mode	Cardiac Care	C_

For information about configuring the friendly name in your target devices, see the documentation provided with those devices.

Bluetooth Setup

Use the *Bluetooth Setup* menu to set up the *Bluetooth* transmission on the LIFEPAK 15 monitor.

To access the *Bluetooth Setup* menu:

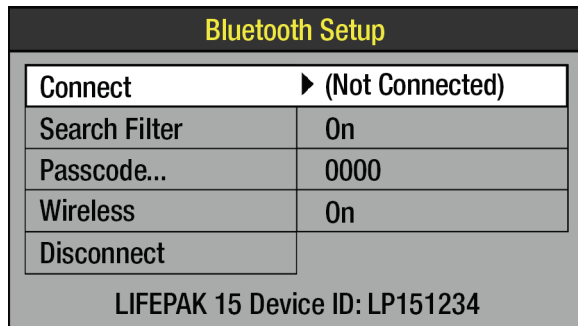

1. On the **HOME SCREEN**, rotate the **SPEED DIAL** to outline the Bluetooth icon.
2. Press the **SPEED DIAL**. The *Bluetooth Setup* menu appears.
3. Set **SEARCH FILTER** to **ON** if you want to find only devices that include the PSC in their friendly name; otherwise, set **SEARCH FILTER** to **OFF**.
4. Set a *Bluetooth* passcode.
 - To transmit to a headless gateway, enter the passcode that is preconfigured in the gateway.
 - To transmit to a PC, you may need to enter a passcode or acknowledge the connection.
5. Ensure that **WIRELESS** is set to **ON**.

Note: The default setting for **WIRELESS** is **ON**, and the default setting for **SEARCH FILTER** is **OFF**. Use the **WIRELESS** setting to turn off the wireless signal when operating the LIFEPAK 15 monitor in an environment where transmission is not desirable.

Establishing a Bluetooth Connection

You must know the friendly name of the target device that you want to connect to.

To establish a *Bluetooth* connection:

Bluetooth Setup	
Connect	(Not Connected)
Search Filter	Find Devices
Passcode...	0000
Wireless	On
Disconnect	
LIFEPAK 15 Device ID: LP151234	
When device appears, select Stop	
C_EMS123	C_HOSPITAL3
C_EMS345	
B_HOSPITAL1	
B_HOSPITAL2	
C_EMS456	
C_EMS789	
Stop	
Bluetooth Setup	
Connect	(Not Connected)
Search Filter	Find Devices...
Passcode...	C_EMS123
Wireless	C_EMS345
Disconnect	B_HOSPITAL1
	B_HOSPITAL2
	C_EMS456

1. On the LIFEPAK 15 monitor, use the **SPEED DIAL** to select the *Bluetooth* icon and access the *Bluetooth Setup* menu.
2. Select **CONNECT** and then select **FIND DEVICES**. This will disconnect any existing connections.

Note: If the LIFEPAK 15 monitor is set to **WIRELESS OFF**, wireless status changes to **WIRELESS ON**.

- The Find Devices menu appears. The monitor begins searching for *Bluetooth* devices that are in the area and that meet the search filter criteria.
 - Devices are displayed in the order found—the most recently found device appears at the top of the list.
3. When the desired device appears, press the **SPEED DIAL** to select **STOP** and end the search. You return to the Bluetooth Setup menu.
 4. Use the **SPEED DIAL** to scroll through the list and select the desired device.
 5. If you are connecting to a PC, you may be prompted to acknowledge the connection. Enter the passcode, if requested, and then accept the connection.
 6. When the connection is made, an alert tone sounds, the Bluetooth LED on the Home Screen is illuminated, and **CONNECTED TO (DEVICE NAME)** briefly appears in the message area.



After you establish a *Bluetooth* connection, you are ready to transmit patient data. Proceed to Transmitting Reports (on page 189).

Re-establishing a Bluetooth Connection

The LIFEPAK 15 monitor retains in its memory two last-connected devices, limited to one in each mode—one for cardiac care (AED or Manual mode) and one for Archive mode. When the LIFEPAK 15 monitor is powered on and the wireless feature is set to **WIRELESS ON**, the monitor automatically searches for the last connected device. If the last connected device in that mode is turned on and within range, a connection is established automatically. When a connection is established, the *Bluetooth* LED is illuminated and **CONNECTED TO (DEVICE NAME)** appears in the message area.

Note: If **RESET DEFAULTS** is selected in Setup mode, the *Bluetooth* passcode is not reset. However, connections to the last-connected devices are reset (terminated). To re-establish a connection, use **FIND DEVICES**.

Table 31 Bluetooth Status

BLUETOOTH ICON	DESCRIPTION
	The <i>Bluetooth</i> LED is illuminated when the <i>Bluetooth</i> feature is enabled in this device and this device is connected to another <i>Bluetooth</i> -enabled device.
	The <i>Bluetooth</i> icon appears but the LED is not illuminated when the <i>Bluetooth</i> feature is enabled in this device, but this device is currently not connected to another <i>Bluetooth</i> -enabled device.
	A red X appears when the <i>Bluetooth</i> feature is installed in this device, but wireless communication is currently set to OFF or there is a <i>Bluetooth</i> malfunction. See Troubleshooting Tips for Data Transmission (on page 192).

Preparing for a Wireless Transmission

Before you can send wireless transmissions from the LIFEPAK 15 monitor, you must prepare the monitor and target devices for communication.

The target device must:

- Be *Bluetooth*-enabled, turned on, and discoverable.
- Have the LIFENET PC Gateway application or the patient care reporting software CODE-STAT or DT EXPRESS installed and running.
- Have a *Bluetooth* COM port configured for incoming data.
- Have an established friendly name.

The LIFEPAK 15 monitor must:

- Have at least one transmission site defined that has **OUTPUT PORT** set to **BLUETOOTH WIRELESS**.
- Have a *Bluetooth* passcode that matches the passcode in the target device, if the target device requires a passcode.
- Have **SEARCH FILTER** set to **ON** if you are using the Physio Service Class. For information about the Physio Service Class, see Bluetooth Search Filter (on page 183) later in this chapter.

Terminating a Bluetooth Connection

When the *Bluetooth* LED is illuminated, the LIFEPAK 15 monitor has a wireless connection established with another *Bluetooth* device.

To terminate a *Bluetooth* connection:

1. Use the **SPEED DIAL** to select the *Bluetooth* icon and access the *Bluetooth* Setup menu.
2. Select **DISCONNECT**. The *Bluetooth* connection is terminated and is not retained as the last connected device.

Using a Direct Connection

A special cable can be used to create a direct connection between the LIFEPAK 15 monitor and a gateway or PC. The following figure shows the equipment connections to send reports directly to a computer using a direct cable connection.

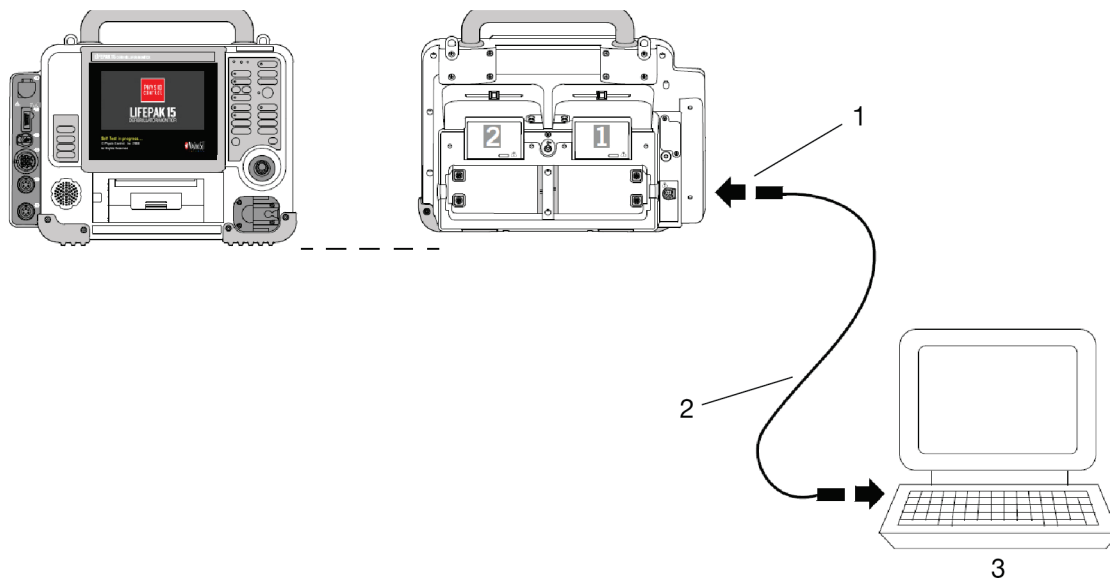

Figure 49 Data Transmission using a Direct Connection

FIGURE LEGEND

- 1 System connector
- 2 LIFEPAK monitor to PC cable
- 3 Computer

WARNING

Shock Hazard

All equipment connected to the system connector must be battery powered or electrically isolated from AC power according to IEC 60601-1. If in doubt, disconnect the patient from the defibrillator before using the system connector. Only use Physio-Control recommended data transmission cables. For more information, contact Physio-Control Technical Support.

WARNING

Improper Device Performance Hazard

RF communication equipment such as cell phones, modems and radios may interfere with the performance of the monitor/defibrillator. If the monitor/defibrillator is used near RF communication equipment, observe the recommended separation distances in Recommended Separation Distances Between Portable and Mobile RF Communications Equipment and the LIFEPAK 15 Monitor/Defibrillator. Certain RF communication equipment can be used at distances that are less than those recommended in these operating instructions. If the separation distance is less than the recommended distance, use only equipment recommended by Physio-Control and observe the monitor/defibrillator to verify normal operation.

To establish a direct connection:

1. Position the PC or LIFENET Gateway within reach of the LIFEPAK 15 monitor.
Note: If you are storing a LIFENET Gateway (modem) in the carrying case, only store the modem in the side pouch. Do not store LIFENET Gateways in the back pouch.
2. Configure a COM port on the PC for incoming data.
3. Connect the cable to the system connector on the monitor and to the PC.
4. If using CODE-STAT or DT EXPRESS software, open the download wizard on the PC and select the LIFEPAK 15 monitor.

After you establish a direct connection, you are ready to transmit patient data. Proceed to Transmitting Reports (on page 189).

Transmitting Reports

After you have established a wireless or direct connection, you can transmit Patient Records and reports. All patient reports can be transmitted real time during patient monitoring (Manual or AED mode), or reports can be transmitted post event (Archive mode).

How to Transmit a Current Patient Report

To transmit a current patient report:

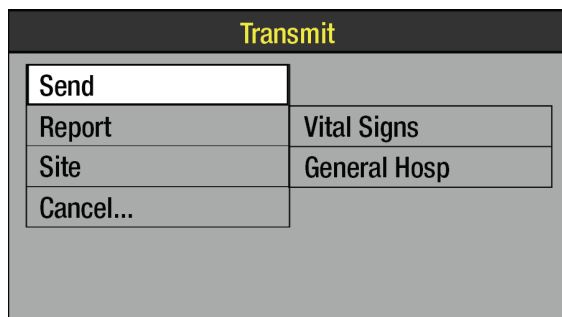

1. Press **TRANSMIT**. The Transmit menu appears.
2. Use the **SPEED DIAL** to select the desired **REPORT** and **SITE**, if necessary.
3. Select **SEND**. The patient report is transmitted. The status of the transmission appears in the message area.

How to Transmit an Archived Patient Report

When you turn off the LIFEPAK 15 monitor/defibrillator, the current Patient Record is saved in the archives. For information about accessing Archive mode, see Data Management (on page 165).

To transmit an archived patient report:

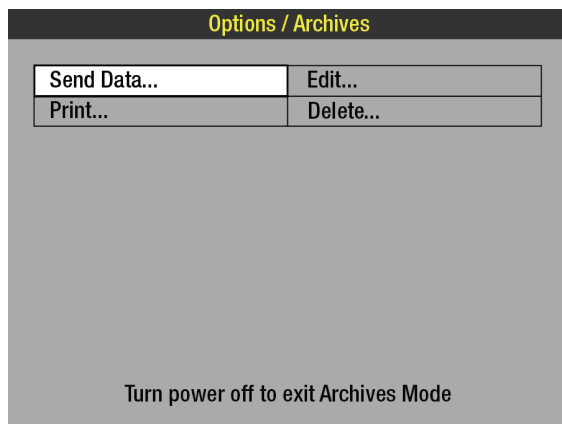

1. In the Options/Archives menu, select **SEND DATA**. The Options/Archives/Send Data menu appears.

Transmitting Reports

Options / Archives / Send Data	
Send	
Patient	All Patients
Report	All
Site	None
Connection...	(Not Connected)
Cancel...	

- If the **PATIENT**, **REPORT**, and **SITE** are correct, proceed to Step 7.

Options / Archives / Send Data	
All Patients	
031008192742	10 MAR 08 19:27:42
LEE, WILLIAM	10 MAR 08 12:15:17
031008105740	10 MAR 08 10:57:40
JARRE, DORA	09 MAR 08 22:15:21
OAKY, GARY	09 MAR 08 15:27:20
JONES, CONRAD	09 MAR 08 10:09:09
030908064823	09 MAR 08 06:48:23
WYNDE, GUSTAV	08 MAR 08 21:45:21
030808062723	08 MAR 08 06:27:23
030808031524	08 MAR 08 03:15:24
030708164503	07 MAR 08 16:45:03
030708093523	07 MAR 08 09:35:23
030708061542	07 MAR 08 06:15:42

- To transmit records for a particular patient, select **PATIENT**. A list of patients appears.
- Select the patient.

Options / Archives / Send Data	
Send	
Patient	
Report	▶ All
Site	Code Summary
Connection...	Trend Summary
Cancel...	Vital Signs

- To transmit a specific report, select **REPORT** and then select the report.
- To select a transmission site, select **SITE** and then select the site. Make sure you specify a site whose **OUTPUT PORT** is configured for the transmission method you are using.
- To transmit using a wireless transaction, select **CONNECTION** and proceed with establishing a Bluetooth connection. For more information, see Establishing a Bluetooth Connection (on page 185).
- Select **SEND**. The patient report is transmitted. The status of the transmission appears in the message area.

Transmission Status Report

Whenever you attempt to transmit a record, a transmission report is automatically printed at the completion of the transmission attempt. The transmission report indicates the date and time of the transmission attempt and the final status of the transmission.

Cancelling a Transmission

You can cancel a transmission that is in process. To cancel a transmission, select **CANCEL** on the Transmit menu if you are transmitting a current record, or select **CANCEL** on the Options/Archives/ Send Data menu if you are transmitting an archived record.

Considerations When Transmitting Data

When considering any treatment protocol that involves transmitting patient data, be aware of possible limitations. Successful transmission depends on access to public or private network services that may or may not always be available. This fact is especially true for wireless communication, which is influenced by many factors, such as:

- Geography
- Location
- Weather
- Number of wireless devices in the area

Treatment protocol must always take into account the fact that data transfer *cannot be assured* using wireless communication. Your treatment protocol must include contingency planning for interrupted data transmission.

Periodically test your device transmission function to ensure that the device and transmission accessories are ready for use.

Troubleshooting Tips

Table 32 Troubleshooting Tips for Data Transmission

OBSERVATION	POSSIBLE CAUSE	CORRECTIVE ACTION
<i>Bluetooth</i> icon on LIFEPAK 15 monitor has red X across it	WIRELESS is set to OFF in the <i>Bluetooth</i> Setup menu	<ul style="list-style-type: none"> Set WIRELESS to ON. If red X remains, <i>Bluetooth</i> module in LIFEPAK 15 monitor may be faulty. Contact qualified service representative.
	WIRELESS is set to OFF in the setup options, so the WIRELESS default is OFF each time the LIFEPAK 15 monitor is turned on	<ul style="list-style-type: none"> Change WIRELESS setup option. See <i>LIFEPAK 15 Monitor/Defibrillator Setup Options</i> provided with your device. If red X remains, <i>Bluetooth</i> module in LIFEPAK 15 monitor may be faulty. Contact qualified service representative.
	<i>Bluetooth</i> module in LIFEPAK 15 monitor may be faulty	<ul style="list-style-type: none"> Contact qualified service representative.
<i>Bluetooth</i> LED is not illuminated	Target device is off or cannot communicate with the LIFEPAK 15 monitor	<ul style="list-style-type: none"> Confirm that target device is on and discoverable. See the operating instructions for your target device.
	<i>Bluetooth</i> module in LIFEPAK 15 monitor may be faulty	<ul style="list-style-type: none"> If other troubleshooting is unsuccessful, contact qualified service representative.
LIFEPAK 15 monitor does not automatically connect to last connected device	Target device is off or cannot communicate with the LIFEPAK 15 monitor	<ul style="list-style-type: none"> Confirm that target device is on and discoverable.
	Last connection to target device may have occurred when the LIFEPAK 15 monitor was in a different mode	<ul style="list-style-type: none"> Confirm that OUTPUT PORT is set to BLUETOOTH WIRELESS. Select FIND DEVICES and establish a new connection.
Device does not connect to last connected device after WIRELESS is set to ON	<i>Bluetooth</i> menu is displayed, which prevents discovery of devices	<ul style="list-style-type: none"> Press HOME SCREEN to exit menu and allow LIFEPAK 15 monitor to find last connected device.
UNABLE TO CONNECT message appears	LIFEPAK 15 monitor cannot establish wireless connection. Target device may not have the necessary software application or cannot accept data.	<ul style="list-style-type: none"> Verify target device is ready to receive transmissions. Attempt to retransmit.

OBSERVATION	POSSIBLE CAUSE	CORRECTIVE ACTION
Unable to find a particular <i>Bluetooth</i> device, or BLUETOOTH DEVICE NOT FOUND message appears	Search filter may be on and target device does not have a PSC prefix	<ul style="list-style-type: none"> • Confirm that target device is on and discoverable. • Confirm friendly name of target device. • Set SEARCH FILTER to OFF and then select FIND DEVICES again.
	Target device is not functioning	<ul style="list-style-type: none"> • Confirm that target device is on and discoverable. • Confirm friendly name of target device. • If message still appears, contact the service provider for your target device.
	<i>Bluetooth</i> module in LIFEPAK 15 monitor may be faulty	<ul style="list-style-type: none"> • Contact qualified service representative.
Unable to transmit data for post-event review using either direct connection or <i>Bluetooth</i> connection	Post-event review software is not installed on target device	<ul style="list-style-type: none"> • Install CODE-STAT or DT EXPRESS post-event review software on target device.
	Post-event review software is not open and running on target device	<ul style="list-style-type: none"> • Make sure the target device is running Device Communications or the download wizard.
	COM port is not configured for incoming data on target device	<ul style="list-style-type: none"> • Configure COM port on target device.
	LIFEPAK 15 monitor not selected in download wizard on target device	<ul style="list-style-type: none"> • Open download wizard on target device and select the LIFEPAK 15 monitor.
BLUETOOTH UNAVAILABLE message appears	<i>Bluetooth</i> module in LIFEPAK 15 monitor not responding	<ul style="list-style-type: none"> • Turn LIFEPAK 15 monitor off and back on. • If message still appears, <i>Bluetooth</i> module may be faulty. Contact qualified service representative.
BLUETOOTH DEVICE NOT FOUND message appears	Unable to locate <i>Bluetooth</i> device	<ul style="list-style-type: none"> • Verify target device is ready to receive transmissions. • Set SEARCH FILTER to OFF and then select FIND DEVICES again.
UNKNOWN DEVICE message appears	<i>Bluetooth</i> name discovery failed or timed out before the device name was obtained	<ul style="list-style-type: none"> • Verify name of target device. • Verify target device is ready to receive transmissions. • Attempt to retransmit.

Troubleshooting Tips

OBSERVATION	POSSIBLE CAUSE	CORRECTIVE ACTION
Unable to transmit using a gateway device that has a functioning direct connection or <i>Bluetooth</i> connection	Transmission sites are not set up in LIFEPAK 15 monitor	<ul style="list-style-type: none"> Define transmission sites. Each site name must exactly match the name of the target device. See <i>LIFEPAK 15 Monitor/Defibrillator Setup Options</i> provided with your device.
	Transmission site names in LIFENET System do not match site names in LIFEPAK 15 monitor	<ul style="list-style-type: none"> Check site names in LIFENET System.
	Cellular communication is not working between the gateway and transmission sites	<ul style="list-style-type: none"> Use alternate method to communicate patient data.
UNABLE TO TRANSMIT message appears	The LIFEPAK 15 monitor cannot connect to the device name selected	<ul style="list-style-type: none"> Verify target device is ready to receive transmissions. Verify target device setup. Attempt to retransmit.
	The output port on the LIFEPAK 15 monitor is not configured for the transmission method you are using	<ul style="list-style-type: none"> Make sure the transmission site OUTPUT PORT is configured for the type of transmission you are attempting. Attempt to retransmit.
	Target device unable to connect or unable to connect within timeout interval	<ul style="list-style-type: none"> Verify target device is ready to receive transmissions. Verify target device setup. Attempt to retransmit.
	The target device requires you to "accept" incoming communications	<ul style="list-style-type: none"> Check your target device for a required acknowledgment to connect. Enter passcode, when prompted. Set to "Always allow" if possible. Attempt to retransmit.
	Direct connection was disrupted	<ul style="list-style-type: none"> Verify cable connections. Attempt to retransmit.
TRANSMISSION FAILED message appears	Computer application program is not ready or is not available to receive transmission	<ul style="list-style-type: none"> Verify target device is running necessary software. Attempt to retransmit.
LOST DIRECT CONNECTION message appears	Direct connection was interrupted	<ul style="list-style-type: none"> Verify cable connections between LIFEPAK 15 monitor and gateway or PC. Attempt to retransmit.
LOST BLUETOOTH CONNECTION message appears	Connection with <i>Bluetooth</i> target device was interrupted	<ul style="list-style-type: none"> Verify target device is ready to receive transmissions. Attempt to retransmit.
TRANSMISSION CANCELLED message appears	Operator of the LIFEPAK 15 monitor cancelled transmission	<ul style="list-style-type: none"> Attempt to retransmit if cancelled in error.

Power Adapter

This section describes the AC Power Adapter and the DC Power Adapter.

Basic Orientation	197
Using the Power Adapter	199
General Maintenance	202
Warranty	203

Basic Orientation

The AC Power Adapter and DC Power Adapter are optional accessories for use only with the LIFEPAK 15 monitor/defibrillator. These power adapters:

- Provide operating power to the monitor/defibrillator with or without batteries installed.
- Provide power to charge batteries installed in the monitor/defibrillator.

The AC Power Adapter operates with either 120 or 240 Vac line power. The DC Power Adapter operates with 12 Vdc power. Installed batteries are charged whenever the power adapter is connected to the LIFEPAK 15 monitor/defibrillator. To help manage and maintain battery charge, the power adapter should be kept plugged into the defibrillator whenever possible. For more information about maintaining the batteries, see Battery Maintenance (on page 215).

Note: AC and DC Power Adapters are not certified for use in EMS environments per IEC 60601-1-12.

Note: Although the monitor/defibrillator can operate using auxiliary power with no batteries installed, at least one battery must be installed at all times.

Note: If the monitor/defibrillator loses power for more than 30 seconds, it will revert to the user-configured default settings and begin a new patient record.

An optional output extension cable is available. The output extension cable is equipped with a breakaway connector to allow quick movement if needed. For more information about the breakaway feature, see Output Extension Cable with Breakaway Connector (on page 201).

IMPORTANT! Daily inspection and testing will help ensure that the power adapter is in good operating condition and is ready for use when needed. Refer to the LIFEPAK 15 monitor/defibrillator Operator's Checklist in the back of this manual.

Carefully read the *Power Adapter Instructions for Use* that are provided with the power adapter for complete instructions, warnings, cautions, and specifications.

WARNING

Possible Loss of Power During Patient Care

Physio-Control has no information regarding the performance or effectiveness of its LIFEPAK monitor/defibrillators if other manufacturers' power adapters are used. Using other manufacturers' power adapters may cause the device to perform improperly and invalidate the safety agency certifications. Use only power adapters that are labeled with the LIFEPAK 15 device symbol shown here. 

WARNING

Possible Loss of Power During Patient Care

Do not use the LIFEPAK 12 power adapter with the LIFEPAK 15 monitor/defibrillator. Use only power adapters that are labeled with the LIFEPAK 15 device symbol. 

WARNING

Possible Loss of Power During Patient Care

If the monitor/defibrillator will be used in emergency environments that require battery power, the installed batteries must be kept fully charged. Keep the power adapter plugged into an auxiliary power source whenever possible to maintain the charge level.

WARNING

Possible Loss of Power During Patient Care

Do not connect more than one output extension cable between the power adapter and the defibrillator. The resultant voltage drop may prevent the power adapter from charging the batteries or operating the defibrillator. Always connect the power adapter directly to the defibrillator or use only one extension cable.

WARNING

Shock Hazard

Using a power line cord other than the one supplied with the power adapter could cause excess leakage currents. Use only the power line cord that is specified for use with the power adapter.

WARNING

Potential Performance Degradation

Physio-Control has no information regarding the performance or effectiveness of the LIFEPAK 15 monitor/defibrillator when the power adapter is used with a power inverter. It is the user's responsibility to verify that the monitor/defibrillator performs correctly when used with a power inverter.

WARNING**Possible Skin Injury**

The power adapter may become warm when used for an extended period of time. Prolonged contact between exposed skin and a warm power adapter may cause skin irritation or burns. If a warm power adapter is placed against a patient, the operator should ensure that the patient's skin is adequately protected.

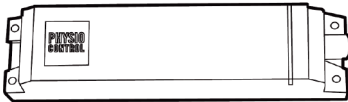

Figure 50 AC Power Adapter

Using the Power Adapter

This section provides information about operating the AC and DC power adapters that can be used with the LIFEPAK 15 monitor/defibrillator.

AC Power Adapter Operation

To use the AC Power Adapter:

1. Connect the AC power cord to the power adapter and a grounded AC outlet.
2. Verify that the green LED strip illuminates.
3. Connect the power adapter output cable to the power adapter.
4. Connect the green end of the power adapter output cable to the auxiliary power connector on the back of the monitor/defibrillator.
5. Verify that the **AUXILIARY POWER** LED on the defibrillator is illuminated.
6. If at least one battery is installed in the device, verify that the **BATTERY CHARGING** indicator is illuminated or flashing. Indicator behaviors are shown in Table, Battery Charging Indicator Behaviors, below.

Table 33 Battery Charging Indicator Behaviors

INDICATOR	DESCRIPTION
Steady green	Installed batteries are fully charged.
Flashing green	One or both installed batteries are being charged.
Off	No batteries are installed, or a battery is unable to be charged.

7. Press the monitor/defibrillator **ON** button.

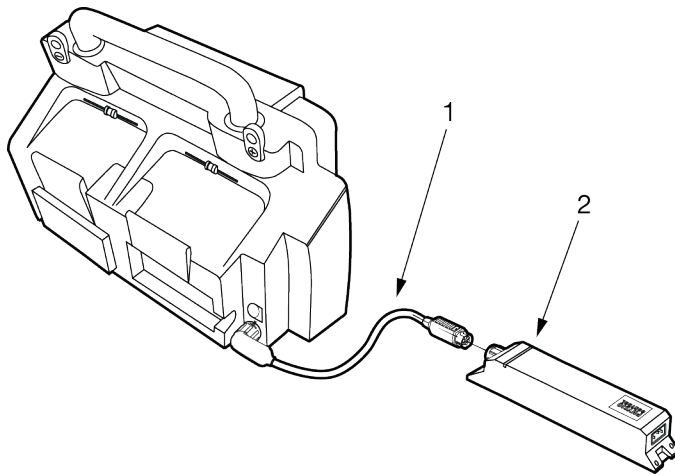

Figure 51 AC Power Adapter with LIFEPAK 15 Monitor/Defibrillator

FIGURE LEGEND

- 1 Power adapter output cable
- 2 LED strip

DC Power Adapter Operation

To use the DC Power Adapter:

1. Connect the DC power cable to the power adapter and a 12 Vdc power source.
2. Verify that the green LED strip illuminates.
3. Connect the power adapter output cable to the power adapter.
4. Connect the green end of the power adapter output cable to the auxiliary power connector on the back of the monitor/defibrillator.
5. Verify that the **AUXILIARY POWER** LED on the defibrillator is illuminated.
6. If at least one battery is installed in the device, verify that the **BATTERY CHARGING** indicator is illuminated or flashing. Indicator behaviors are shown in Table, Battery Charging Indicator Behaviors, below.

Table 34 Battery Charging Indicator Behaviors

INDICATOR	DESCRIPTION
Steady green	Installed batteries are fully charged.
Flashing green	One or both installed batteries are being charged.
Off	No batteries are installed, or a battery is unable to be charged.

7. Press the defibrillator **ON** button.

Output Extension Cable with Breakaway Connector

One optional output extension cable may be connected between the power adapter and the power adapter output cable, if desired. The output extension cable is equipped with a breakaway connector that can be pulled apart without manually rotating the lock ring. With the breakaway connector, you can quickly separate the monitor/defibrillator from the power adapter without damaging the cables or connectors.

To use the breakaway feature, the power adapter and output extension cable must be secured as described in the *Power Adapter Instructions for Use*. The breakaway connector is designed to withstand routine breakaway use. However, to prolong the life of the connector, manually disconnect it whenever possible.

To order the output extension cable, contact your Physio-Control representative. In the USA, call Customer Support at 1.800.442.1142, option 2.

IMPORTANT! Do not use more than one output extension cable.

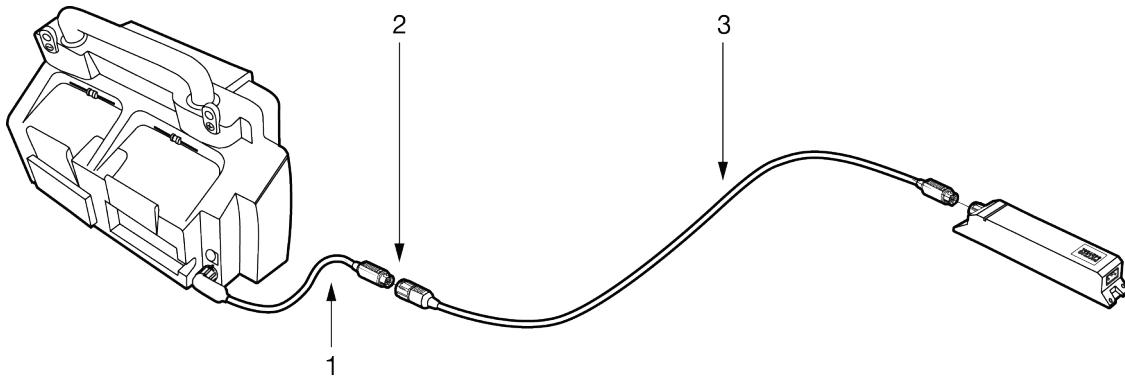

Figure 52 Output Extension Cable with Breakaway Connector

FIGURE LEGEND

- 1 Power adapter output cable
- 2 Breakaway connector
- 3 Output extension cable

General Maintenance

Maintenance and Service

The power adapter contains no serviceable parts. If the power adapter does not function correctly, contact your local Physio-Control representative for assistance.

Cleaning

WARNING

Possible Electrical Shock

Unplug the power adapter from the power source before cleaning.

CAUTION

Possible Equipment Damage

Do not clean any part of the power adapter or its accessories with phenolic compounds. Do not use abrasive or flammable cleaning agents. Do not attempt to sterilize this device or any accessories unless otherwise specified in accessory operating instructions.

To clean the power adapter:

1. Unplug the power adapter, if it is connected to an auxiliary power source.
2. Clean the power adapter, power cord, and cables with a damp sponge or cloth. Use only the cleaning agents listed below:
 - Quaternary ammonium compounds
 - Isopropyl alcohol
 - Peracetic (peroxide) acid solutions
 - Sodium dichloroisocyanurate (NaDCC)
 - Chlorine bleach (1:10 dilution)

Note: Carefully clean the connector ports. Do not allow cleaning fluids to penetrate the exterior surfaces of the device.

Troubleshooting Tips

Table 35 Troubleshooting Tips for Power Adapter

OBSERVATION	POSSIBLE CAUSE	CORRECTIVE ACTION
POWER LED on power adapter does not light	Power cord not plugged into power adapter or power source	<ul style="list-style-type: none"> Connect power cord.
	Defective power adapter or power cord	<ul style="list-style-type: none"> Replace with working power adapter and power cord.
	Blown fuse or tripped circuit breaker in building	<ul style="list-style-type: none"> Contact qualified service personnel.
AUXILIARY POWER LED on monitor/defibrillator not illuminated	Power adapter not properly connected to auxiliary power source or monitor/defibrillator	<ul style="list-style-type: none"> Check that power adapter is connected properly.
	Defective power adapter or cables	<ul style="list-style-type: none"> Replace with working power adapter and cables.
BATTERY CHARGING LED on monitor/defibrillator not illuminated	Power adapter not properly connected to auxiliary power source or monitor/defibrillator	<ul style="list-style-type: none"> Check that power adapter is connected properly.
	Battery not properly inserted in battery well	<ul style="list-style-type: none"> Check that battery is properly inserted in battery well.
	Unable to charge battery with power adapter because battery charge level is too low	<ul style="list-style-type: none"> Charge battery in Station-Mobile or REDI-CHARGE battery charger if available. Replace battery.
	No batteries installed	<ul style="list-style-type: none"> Install at least one battery.
	Defective battery	<ul style="list-style-type: none"> Remove battery from service and replace with working battery.
	Unrecognized battery	<ul style="list-style-type: none"> Only use battery that is approved for use with the LIFEPAK 15 monitor/defibrillator.
	Incompatible power adapter connected to the monitor/defibrillator	<ul style="list-style-type: none"> Only use power adapter that is approved for use with the LIFEPAK 15 monitor/defibrillator.
	Defective power adapter or cables	<ul style="list-style-type: none"> Replace with working power adapter and cables.
	Monitor/defibrillator unable to recognize installed battery	<ul style="list-style-type: none"> Contact qualified service personnel.

Warranty

To obtain a detailed warranty statement, contact your local Physio-Control representative or go to www.physio-control.com.

Maintaining the Equipment

This chapter describes how to perform operator-level maintenance, testing, and troubleshooting for the LIFEPAK 15 monitor/defibrillator and selected accessories. For additional information about accessories, refer to specific accessory operating instructions.

General Maintenance and Testing	207
Battery Maintenance	215
Cleaning the Device.....	218
Storing the Device	218
Loading Paper	219
General Troubleshooting Tips	220
Service and Repair	224
Service Life	224
Product Recycling Information.....	225
Warranty	225
Accessories	226

General Maintenance and Testing

Periodic maintenance and testing of the LIFEPAK 15 monitor/defibrillator and accessories are important to help prevent and detect possible electrical and mechanical discrepancies. If testing reveals a possible discrepancy with the defibrillator or accessories, see General Troubleshooting Tips (on page 220). If the discrepancy cannot be corrected, immediately remove the LIFEPAK 15 monitor/defibrillator from service and contact a qualified service technician. For testing information regarding accessories, see the accessory operating instructions.

A **MAINTENANCE DUE** message can be set up to appear at selected intervals (3, 6, or 12 months) to remind you that the LIFEPAK 15 monitor/defibrillator is due for maintenance. The factory default is **OFF**, but it can be activated by service personnel.

An Operator's Checklist is included in the back of this manual. You may reproduce the checklist and use it to inspect and test the LIFEPAK 15 monitor/defibrillator. Daily inspection and test is recommended.

Maintenance and Testing Schedule

Table, Recommended Maintenance Schedule for Clinical Personnel (on page 208), lists the recommended maintenance and testing schedule. This schedule may be used in conjunction with the internal quality assurance program of the hospital, clinic, or emergency medical service where the defibrillator is used.

To ensure proper performance of the monitor/defibrillator, inspect and test the power adapter daily as described in the Operator's Checklist.

Cables and paddles are a critical part of therapy delivery and suffer wear and tear. Therapy cable testing as described in the Operator's Checklist is recommended on a daily basis. The Test Load ships with the device and is necessary for testing the QUIK-COMBO cable. Physio-Control recommends replacement of therapy cables every three years to reduce the possibility of failure during patient use.

The 12-lead ECG cable is a critical part of diagnosis and suffers wear and tear. Inspect the 12-lead cable as described in the Operator's Checklist, and test it as described in Patient ECG Cable Check (on page 210).

Additional periodic preventive maintenance and testing—such as electrical safety tests, performance inspection, and required calibration—should be performed regularly by qualified service technicians. For detailed maintenance recommendations for each feature, see the *LIFEPAK 15 Monitor/Defibrillator Service Manual*.

General Maintenance and Testing

Table 36 Recommended Maintenance Schedule for Clinical Personnel

OPERATION	DAILY	AFTER USE	AS REQUIRED	6 MONTHS	12 MONTHS
Complete Operator's Checklist. Includes QUIK-COMBO therapy cable check and Standard (hard) paddles check	X				
Inspect defibrillator	X	X			
Check that all necessary supplies and accessories are present (for example, fully charged batteries, gel, electrodes, ECG paper, etc.)	X	X	X		
Function Checks:					
Patient ECG Cable Check (on page 210)				X	
Standard Paddles Synchronized Cardioversion Check (on page 210)				X	
Therapy Cable Monitoring and Synchronized Cardioversion Check (on page 212)				X	
Therapy Cable Pacing Check (on page 213)				X	
Clean defibrillator		X	X		
Preventive Maintenance and Testing					X

Self-Tests

Each time you turn on the LIFEPAK 15 monitor/defibrillator, it performs internal self-tests to check that internal electrical components and circuitry work properly. The defibrillator stores the results of all user-initiated self-tests in a test log.

When the defibrillator is on and a problem is detected that requires immediate service, such as a malfunctioning charging circuit, the Service LED is illuminated.

For more information, see General Troubleshooting Tips (on page 220).

Auto Tests

The defibrillator performs an automatic self-test daily at 03:00 (3:00 A.M.), if not in use. During the automatic self-test, the defibrillator turns itself on (**ON LED** illuminates) briefly and completes the following tasks:

- Performs a self-test
- Stores the self-test results in the test log
- Prints the self-test results
- Transmits the self-test results if the **TRANSMIT RESULTS** option is enabled. (Transmission may take up to 4 minutes.)
- Turns itself off

If the defibrillator detects a problem during an auto test, it annotates the fault condition on the printed test report.

For more information about enabling the **TRANSMIT RESULTS** option, see the *LIFEPAK 15 Monitor/Defibrillator Setup Options* guide provided with your device.

The automatic self-test is not performed if the defibrillator is already turned on at 03:00 or if power is not available. If the defibrillator is manually turned on while a self-test is in progress, the self-test is halted and the defibrillator turns on normally.

For more information, see General Troubleshooting Tips (on page 220).

User Tests

The User Test is a functional test of the LIFEPAK 15 monitor/defibrillator. The User Test should be performed only as a test and not while using the defibrillator during patient care. Perform the User Test as a part of completing the daily Operator's Checklist.

Note: The defibrillator must be in Manual mode to perform the User Test.

To perform a User Test separate from completing the Operator's Checklist:

1. Press **ON** to turn on the LIFEPAK 15 monitor/defibrillator.
2. Press **OPTIONS**. The Options menu appears.
3. Select **USER TEST**. The defibrillator performs the following tasks:
 - Self-tests to check the device.
 - Charges to 10 joules and discharges internally (this energy is not accessible at the therapy connector).
 - Prints a Pass/Fail report.

If the LIFEPAK 15 monitor/defibrillator detects a failure during the User Test, the Service LED is illuminated and the printed report indicates that the test failed. Remove the defibrillator from use and contact a qualified service technician.

If you must interrupt the User Test, turn the power off and then on again. The test stops and the defibrillator operates normally. A Pass/Fail report does not print.

Note: During the User Test, all front panel controls (except **ON**) and standard paddle controls are disabled. Routinely testing the defibrillator consumes battery power; maintain all batteries as described in Battery Warnings (on page 215).

Note: The last 40 User and Auto Test results are transmitted with all reports to the CODE-STAT Suite data management system.

Note: It is important to understand defibrillator operation. For suggested procedures to help keep personnel acquainted with normal defibrillator operation, see the function checks that are provided in this chapter. The function checks used may vary according to your local protocols. To test the defibrillator by performing the function checks, you need a simulator. To troubleshoot device performance, see General Troubleshooting Tips (on page 220).

Standard (Hard) Paddles Check

Perform the standard paddles check as a part of completing the daily Operator's Checklist that is provided in the back of this manual.

Function Checks

The following function checks are provided to help personnel keep acquainted with normal operating procedures and to troubleshoot LIFEPAK 15 monitor/defibrillator performance.

Note: If your organization downloads device electronic patient records for post-event review, consider entering "TEST" as the patient's name to distinguish simulator function tests from actual patient uses.

Patient ECG Cable Check

Equipment Needed:

- LIFEPAK 15 monitor/defibrillator
- Fully charged batteries or power adapter connected to a reliable power source
- Patient ECG cable (3-lead, 12-lead, or 5-wire)
- 3-lead or 12-lead simulator

To check the patient ECG cable:

1. Press **ON**.
2. Connect the ECG cable to the defibrillator.
3. Connect all cable leads to the simulator.
4. Turn on the simulator and select a rhythm.
5. Confirm that Lead II is selected.
6. After a few seconds, confirm that the screen displays a rhythm and that no **LEADS OFF** or **SERVICE** message appears.
7. For 12-lead cable, press **12-LEAD** and wait for printout. Confirm that a rhythm prints for each lead.

Standard Paddles Synchronized Cardioversion Check

WARNING

Shock Hazard

The defibrillator delivers up to 360 joules of electrical energy. Unless discharged properly as described in this test, this electrical energy may cause serious personal injury or death. Do not attempt to perform this test unless you are qualified by training and experience and are thoroughly familiar with these operating instructions.

Equipment Needed:

- LIFEPAK 15 monitor/defibrillator
- Standard paddles
- Defibrillator checker
- Patient ECG cable
- 3-lead or 12-lead patient simulator
- Fully charged batteries or power adapter connected to a reliable power source

To check standard paddles synchronized cardioversion:

1. Press **ON**.
2. Connect the ECG cable to the monitor and to the patient simulator.
3. Turn on the simulator and select any rhythm except asystole or ventricular fibrillation.
4. Select Lead **II**.
5. Press **SYNC**. Confirm that the **SYNC** LED lights. Adjust ECG size until the sense markers appear on the QRS complexes. Confirm that the **SYNC** LED blinks off with each detected QRS complex and that the heart rate is displayed.
6. Select **100 JOULES**.
7. Press **CHARGE** and confirm that the tone indicating full charge sounds within 10 seconds or less.
8. Remove the standard paddles from the paddle wells and place the standard paddles on the defibrillator checker plates.

Note: This test is not intended to be performed with the paddles in the wells. Discharging 100 joules in the paddle wells may damage the defibrillator.

9. Press the **APEX** ⚡ (shock) button, confirm that the defibrillator does not discharge, and then release the button.
10. Press the **STERNUM** ⚡ (shock) button, confirm that the defibrillator does not discharge, and then release the button.
11. Press **PRINT**.

WARNING**Possible Paddle Damage and Patient Burns**

Press paddles firmly onto the defibrillator checker plates when discharging to prevent arcing and formation of pits on paddle surfaces. Pitted or damaged paddles may cause patient skin burns during defibrillation.

12. Apply firm pressure with both paddles on the defibrillator checker paddle plates, and simultaneously press and hold both ⚡ (shock) buttons while observing the screen.
13. Confirm that the defibrillator discharges on the next sensed QRS complex.
14. Press **PRINT** again to stop the printer.

15. Confirm that the defibrillator returns to Asynchronous mode (sense markers are no longer displayed and **SYNC** LED is off).

Note: Defibrillator may be set up to remain in Sync mode after discharge.

16. Confirm that the printer annotates the time, date, Sync On, sense markers prior to energy delivered, energy selected, no sense markers after Shock 1, and Sync Off on the ECG strip.
17. Turn off the defibrillator.

Note: If a **CONNECT CABLE**, **PADDLES LEADS OFF**, or any other warning message appears, replace the paddle assembly with a new paddle assembly and repeat the test. If the problem cannot be corrected, remove the device from active use and contact a qualified representative.

Therapy Cable Monitoring and Synchronized Cardioversion Check

CAUTION

Possible Simulator Damage

Do not discharge more than 30 shocks within an hour, or 10 shocks within a five-minute period, or pace continually into Physio-Control patient simulators. Simulators may overheat.

Equipment Needed:

- LIFEPAK 15 monitor/defibrillator
- QUIK-COMBO therapy cable
- Patient ECG cable
- 3-lead or 12-lead patient simulator with QUIK-COMBO connector
- Fully charged batteries or power adapter connected to a reliable power source

To check therapy cable monitoring and synchronized cardioversion:

1. Press **ON**.
2. Connect the ECG cable to the defibrillator and to the simulator.
3. Connect the therapy cable to the simulator.
4. Turn on the simulator and select any rhythm except asystole or ventricular fibrillation.
5. Select **PADDLES** lead.
6. Confirm that the screen displays an ECG and that the **PADDLES LEADS OFF** message does not appear.

Note: If the screen displays dashed lines, artifact (irregular noise signals), or any warning message, replace the therapy cable and repeat the test. If the problem cannot be corrected, remove the defibrillator from active use and contact a qualified service representative.

7. Select Lead **II**.

8. Press **SYNC**. Confirm that the **SYNC** LED lights and the Sync mode message appears. Adjust ECG size until sense markers appear on the QRS complexes. Confirm that the **SYNC** LED blinks off with each detected QRS complex and that the heart rate is displayed.
9. Select **50 JOULES**.
10. Press **CHARGE**.
11. Press **PRINT**.

WARNING**Shock Hazard**

During defibrillation checks, the discharged energy passes through the cable connectors. Securely attach cable connectors to the simulator.

12. After the tone sounds indicating full charge, press and hold  (shock) while observing the Home Screen.
13. Confirm that the defibrillator discharges on the next sensed QRS complex.
14. Press **PRINT** again to stop the printer.
15. Confirm that the defibrillator returns to Asynchronous mode (sense markers are no longer displayed and **SYNC** LED is off).

Note: Defibrillator may be set up to remain in Sync mode after discharge.
16. Select **PADDLES** lead.
17. Disconnect the therapy cable from the simulator. Confirm that the **PADDLES LEADS OFF** message appears and that an audible tone occurs.
18. Confirm that the printer annotates the time, date, Sync On, sense markers prior to energy delivered, energy selected, no sense markers after Shock 1, and Sync Off on the ECG strip.
19. Turn off the defibrillator.

Therapy Cable Pacing Check

Equipment Needed:

- LIFEPAK 15 monitor/defibrillator
- QUIK-COMBO therapy cable
- Patient ECG cable
- 3-lead or 12-lead patient simulator with QUIK-COMBO connector
- Fully charged batteries or power adapter connected to a reliable power source

To check therapy cable pacing:

1. Press **ON**.
2. Connect the QUIK-COMBO therapy cable to the simulator.

3. Turn on the simulator and select **BRADY**.
4. Connect the ECG cable to the defibrillator and to the simulator.
5. Select Lead **II**.
6. Press **PACER**.
7. Confirm that sense markers appear on each QRS complex. If sense markers do not appear, or appear elsewhere on the ECG, press the **SPEED DIAL** on waveform Channel 1 and adjust ECG size from the menu.
8. Confirm that the **RATE** menu appears.
9. Press **CURRENT** and increase the current to 80 mA.
10. Observe the screen for captured complexes. Confirm the **PACER** LED flashes with each delivered pacing pulse.
11. Disconnect the QUIK-COMBO therapy cable from the simulator. Confirm that the pacemaker stops pacing, the **CONNECT ELECTRODES** message appears, and an audible alarm sounds.
12. Reconnect the QUIK-COMBO therapy cable to the simulator. Confirm that the audible alarm stops, the **PACING STOPPED** message is displayed, and current is 0 mA.
13. Wait approximately 30 seconds and confirm that an audible alarm occurs.
14. Increase current to 80 mA. Confirm that audible alarm stops.
15. Press **CHARGE**. Confirm that the **PACER** LED goes off and that heart rate and available energy are displayed.

Battery Maintenance

This section provides information about the Physio-Control Lithium-ion batteries that are specifically designed for use in the LIFEPAK 15 monitor/defibrillator. Lithium-ion batteries are low maintenance and require no scheduled cycling to prolong battery life.

IMPORTANT! The LIFEPAK 15 monitor/defibrillator Lithium-ion batteries, battery chargers, power adapters, and power cords are not interchangeable with batteries, battery chargers, power adapters, and power cords that are used in other LIFEPAK defibrillators.

Battery Warnings

WARNING

Possible Fire, Explosion, and Burns

Do not disassemble, puncture, crush, heat above 100°C (212°F), or incinerate the battery.

WARNING

Possible Loss of Power and Delay of Therapy During Patient Care

Using an improperly maintained battery to power the defibrillator may cause power failure without warning. Use the appropriate Physio-Control battery charger to charge batteries.

WARNING

Possible Loss of Power During Patient Care

Physio-Control has no information regarding the performance or effectiveness of its LIFEPAK monitor/defibrillators if other manufacturers' batteries, battery chargers, or power adapters are used. Using other manufacturers' batteries, battery chargers, or power adapters may cause the device to perform improperly and invalidate the safety agency certifications. Use only Physio-Control LIFEPAK 15 monitor/defibrillator batteries (PN 3206735) and the appropriate Physio-Control LIFEPAK 15 monitor/defibrillator battery charger or power adapter.

WARNING

Possible Loss of Power During Patient Care

Battery pins in the defibrillator may be damaged if batteries are dropped or forced into battery wells. Inspect pins routinely for signs of damage. Keep batteries installed at all times except when device is removed from service for storage.

CAUTION

Possible Equipment Damage

When storing the LIFEPAK 15 monitor/defibrillator for an extended period of time, the battery should be removed from the device.

Receiving New Batteries

New batteries do not arrive fully charged. Charge each new battery before use. Batteries may be charged using any of the following devices:

- Station Lithium-ion battery charger for use with the LIFEPAK 15 monitor/defibrillator
- Mobile Lithium-ion battery charger for use with the LIFEPAK 15 monitor/defibrillator
- REDI-CHARGE battery charger
- AC power adapter for use with the LIFEPAK 15 monitor/defibrillator
- DC power adapter for use with the LIFEPAK 15 monitor/defibrillator

Storing Batteries

Li-ion batteries self-discharge during storage.

If you store the battery:

- Do not remove the Charge Before Use label to indicate that the battery has not yet been charged.
 - Store batteries at temperatures between 20° to 25°C (68° to 77°F).
 - Charge the battery fully within one year of when you receive it. Fully recharge the battery once per year thereafter.
-

WARNING

Possible Loss of Power During Patient Care

Stored batteries lose charge. Failure to charge a stored battery before use may cause device power failure without warning. Always charge a stored battery before placing it in active use.

Charging Batteries

- Charge batteries before use. Batteries may be charged in a battery charger, or in the LIFEPAK 15 monitor/defibrillator if it is connected to an auxiliary power source using a LIFEPAK 15 monitor/defibrillator power adapter.
- Inspect batteries for damage or leakage. If battery is damaged or leaking, recycle the battery and obtain a new battery.
- Remove the Charge Before Use label from new batteries before placing batteries in the charger or in the LIFEPAK 15 monitor/defibrillator.
- The battery fuel gauge does not function until the battery is charged. For more information about the fuel gauge, see Batteries (on page 35).
- For more information about charging batteries, refer to either the *Instructions for Use* provided with your battery charger, or the Power Adapter (on page 195) chapter if using the power adapter.

Replacing Batteries

Physio-Control recommends that batteries be replaced approximately every two years. Properly maintained batteries may last longer. A battery has reached the end of useful life if *one or more* of the following circumstances occur:

- Physical damage occurs to the battery case, for example, cracks or a broken clip.
- The battery is leaking.
- The battery charger indicates **FAULT**.
- The battery fuel gauge indicates two or fewer LEDs (bars) after the battery completes a charge cycle.

Dispose of used batteries promptly. Keep batteries away from children.

Recycling Batteries

To promote awareness of battery recycling, Physio-Control batteries are marked with one of these symbols:



When a battery has reached the end of its useful life, recycle the battery according to national and local regulations. Contact your local Physio-Control representative for assistance.

Cleaning the Device

CAUTION

Possible Equipment Damage

Do not clean any part of this device or its accessories with bleach, bleach dilution, or phenolic compounds. Do not use abrasive or flammable cleaning agents. Do not attempt to sterilize this device or any accessories unless otherwise specified in accessory operating instructions.

Clean the LIFEPAK 15 monitor/defibrillator, therapy and ECG cables, and batteries with a damp sponge or cloth. Use only the cleaning agents listed below:

- Quaternary ammonium compounds
- Isopropyl alcohol
- Peracetic (peroxide) acid solutions

Note: Carefully clean the connector ports. Do not allow cleaning fluids to penetrate the exterior surfaces of the device.

Clean the carrying case accessory as follows and as described on its instruction tag:

- Hand wash using mild soap or detergent and water. A scrub brush may be useful for heavily soiled spots. Cleaners such as Formula 409® are helpful for grease, oil, and other tough stains.

For information about cleaning the reusable monitoring sensors and cables, see the individual monitoring section.

Storing the Device

To take the LIFEPAK 15 monitor/defibrillator out of service and store it for an extended period of time, follow these guidelines:

- Remove the batteries.
- Store the defibrillator and batteries at room temperature.

For more information about storage and operating specifications, see Environmental Specifications.

To return the LIFEPAK 15 monitor/defibrillator to service, perform the following tasks:

- Complete the tasks listed in the Operator's Checklist located at the end of this manual. If the Operator's Checklist can not be located, a copy is available at www.physio-control.com.
- Consider having the device serviced by a qualified service technician.

Loading Paper

Check the amount of paper in the printer as part of the daily check according to the Operator's Checklist provided in the back of this manual.

CAUTION

Possible Printer Malfunction

Using other manufacturers' printer paper may cause the printer to function improperly or damage the print head. Use only Physio-Control printer paper.

The printer is equipped with an out-of-paper sensor to protect the printer printhead. The sensor automatically turns off the printer if paper runs out or the printer door is open.

To load paper:

1. Lift the printer door latch to release the door (see Figure, Loading Paper).
2. Pull out the printer door.
3. Remove the empty paper spool, if present.
4. Insert a new paper roll with the graph side facing up. Make sure the end of the paper extends outward so it is exposed when the printer door is closed.
5. Close the printer door and press down on the latch until the door clicks shut.

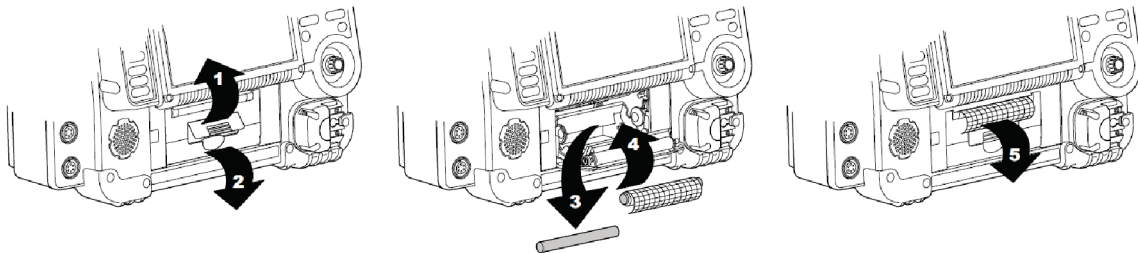

Figure 53 Loading Paper

General Troubleshooting Tips

If a problem is detected with the LIFEPAK 15 monitor/defibrillator during operation or testing, refer to the following troubleshooting tips. If the problem cannot be corrected, remove the LIFEPAK 15 monitor/defibrillator from active use and contact a qualified service technician for service and repair.

Table 37 General Troubleshooting Tips

OBSERVATION	POSSIBLE CAUSE	CORRECTIVE ACTION
No power when monitor/defibrillator is turned ON	Low battery voltage	<ul style="list-style-type: none"> Replace with fully charged, properly maintained battery.
	Battery connector pin loose, covered with foreign substance, or damaged	<ul style="list-style-type: none"> Remove battery and inspect pins. Clean if foreign substance present. Contact a qualified service technician to replace if bent, cracked, or loose.
	Power adapter not properly connected to auxiliary power source	<ul style="list-style-type: none"> Check that power adapter is properly connected to auxiliary power.
	Power adapter not properly connected to monitor/defibrillator	<ul style="list-style-type: none"> Check that power adapter is properly connected to monitor/defibrillator.
	Defective power adapter or cables	<ul style="list-style-type: none"> Replace with working power adapter and cables.
ON LED illuminated, but screen is blank and device does not operate	Defective battery	<ul style="list-style-type: none"> Remove battery from service and replace with working battery.
	Device boot up has failed	<ul style="list-style-type: none"> Press and hold ON until LED turns off (~5 seconds). Then press ON to turn device back on. If device does not turn off, remove both batteries and disconnect device from power adapter, if applicable. Then reinsert batteries, reconnect power adapter, and press ON to turn device back on.
AUXILIARY POWER LED not illuminated	Power adapter not properly connected to auxiliary power source	<ul style="list-style-type: none"> Check that power adapter is properly connected to auxiliary power.
	Power adapter not properly connected to monitor/defibrillator	<ul style="list-style-type: none"> Check that power adapter is properly connected to monitor/defibrillator.
	Defective power adapter or cables	<ul style="list-style-type: none"> Replace with working power adapter and cables.

OBSERVATION	POSSIBLE CAUSE	CORRECTIVE ACTION
BATTERY CHARGING LED on monitor/defibrillator not illuminated	Power adapter not properly connected to auxiliary power source or monitor/defibrillator	<ul style="list-style-type: none"> Check that power adapter is connected properly.
	Battery not properly inserted in battery well	<ul style="list-style-type: none"> Check that battery is properly inserted in battery well.
	Unable to charge battery with power adapter because battery charge level is too low.	<ul style="list-style-type: none"> Charge battery in Station-Mobile or REDI-CHARGE battery charger if available. Replace battery.
	No batteries installed	<ul style="list-style-type: none"> Install at least one battery.
	Defective battery	<ul style="list-style-type: none"> Remove battery from service and replace with working battery.
	Unrecognized battery	<ul style="list-style-type: none"> Only use battery that is approved for use with the LIFEPAK 15 monitor/defibrillator.
	Incompatible power adapter connected to the monitor/defibrillator	<ul style="list-style-type: none"> Only use power adapter that is approved for use with the LIFEPAK 15 monitor/defibrillator.
	Defective power adapter or cables	<ul style="list-style-type: none"> Replace with working power adapter and cables.
	Monitor/defibrillator unable to recognize installed battery	<ul style="list-style-type: none"> Contact qualified service personnel.
CANNOT CHARGE BATTERY message appears	Defective battery	<ul style="list-style-type: none"> Remove battery from service and replace with working battery.
	Defective power adapter	<ul style="list-style-type: none"> Replace with working power adapter and cables.
	Device unable to charge battery or batteries	<ul style="list-style-type: none"> Contact qualified service personnel.
Fuel gauge on battery does not illuminate	Extremely depleted battery	<ul style="list-style-type: none"> Charge battery in Station-Mobile or REDI-CHARGE battery charger.
	Faulty battery	<ul style="list-style-type: none"> Replace battery.

General Troubleshooting Tips

OBSERVATION	POSSIBLE CAUSE	CORRECTIVE ACTION
Device turns off unexpectedly	High power draw	<ul style="list-style-type: none"> Press ON immediately to turn device back on.
	Low battery power	<ul style="list-style-type: none"> Replace battery immediately. Press ON to turn device back on.
	RF equipment too close to defibrillator	<ul style="list-style-type: none"> Separate RF equipment from defibrillator. See Separation Distances (on page 300). Press ON to turn device back on.
	Cellular equipment too close to installed battery	<ul style="list-style-type: none"> Move cellular equipment away from installed battery. Press ON to turn device back on. If device does not turn on, replace battery.
	LIFENET Gateway (modem) too close to installed battery	<ul style="list-style-type: none"> Store modem in side pouch of defibrillator. Do not store modem in back pouch. Press ON to turn device back on. If device does not turn on, replace battery.
Device won't turn off	ON not pressed long enough to turn off device	<ul style="list-style-type: none"> Press and hold ON for at least two seconds.
Monitor/defibrillator operates, but screen is blank	Operating temperature is too low or too high	<ul style="list-style-type: none"> Operate defibrillator within specified ambient temperature range.
	Screen not operating properly	<ul style="list-style-type: none"> Print ECG strip to assess rhythm and other active vital signs. Press ANALYZE and use AED mode, if necessary. Contact qualified service technician.
Monitor/defibrillator operates, but screen not readable	Screen in direct sunlight	<ul style="list-style-type: none"> Change screen from color to black and white. Reposition or shield device. Print ECG strip to assess rhythm and other active vital signs. Press ANALYZE and use AED mode, if necessary.
CHECK PRINTER message appears	Printer paper jams, slips, or misfeeds	<ul style="list-style-type: none"> Reinstall paper. If problem persists, contact qualified service technician.
	Printer is out of paper	<ul style="list-style-type: none"> Add new paper.

OBSERVATION	POSSIBLE CAUSE	CORRECTIVE ACTION
Service LED illuminates	Device self-test circuitry detects service condition	<ul style="list-style-type: none"> Continue to use defibrillator or pacemaker, if needed. Turn device off and then on again. Note that this creates a new "patient." If Service LED does not clear, remove device from active use. Report occurrence of Service LED to qualified service personnel. Obtain another defibrillator, if necessary.
ECG monitoring problems		<ul style="list-style-type: none"> See Troubleshooting Tips (on page 58).
Problems with AED operation		<ul style="list-style-type: none"> See Troubleshooting Tips (on page 135).
Problems with defibrillation/synchronized cardioversion		<ul style="list-style-type: none"> See Troubleshooting Tips (on page 145).
Problems with pacing		<ul style="list-style-type: none"> See Troubleshooting Tips (on page 152).
Displayed time is incorrect	Time is incorrectly set	<ul style="list-style-type: none"> Change the time setting. See Options (on page 43).
Date printed on report is incorrect	Date is incorrectly set	<ul style="list-style-type: none"> Change the date setting. See Options (on page 43).
Displayed messages are faint or flicker	Low battery power Out of temperature range	<ul style="list-style-type: none"> Replace the battery immediately. Connect to auxiliary power using approved power adapter.
Low speaker volume	Moisture in speaker grill holes	<ul style="list-style-type: none"> Wipe moisture from speaker grill and allow device to dry.
MAINTENANCE DUE message appears	Maintenance prompt is set to display at a selected interval in Service mode	<ul style="list-style-type: none"> Continue to use device, if needed. Contact service personnel to perform routine maintenance. Contact Physio-Control Technical Support for instructions on how to reset or turn off this prompt.

Service and Repair

WARNING

Shock Hazard

Do not disassemble the defibrillator. It contains no operator serviceable components and dangerous high voltages may be present. Contact a qualified service technician for repair.

WARNING

Ineffective Energy Delivery Hazard

Service mode is for authorized personnel only. Improper use of Service mode may inappropriately alter the device's configuration and may change energy output levels. Contact qualified service technician for assistance or information about device configuration.

If the LIFEPAK 15 monitor/defibrillator requires service as indicated by testing, troubleshooting, or a service message, contact a qualified service technician. In the USA, call Physio-Control Technical Support at 1.800.442.1142.

When calling Physio-Control to request service, identify the model and serial number and describe the observation. If the device must be shipped to a service center or the factory, pack the device in the original shipping container, if possible, or in protective packing to prevent shipping damage.

The *LIFEPAK 15 Monitor/Defibrillator Service Manual* provides detailed technical information to support service and repair by a qualified service technician.

Service Life

The LIFEPAK 15 Monitor/Defibrillator has an 8-year expected service life under normal use conditions and with appropriate periodic maintenance.

Product Recycling Information

Recycle the device at the end of its useful life. Do not dispose of this product or its batteries in the unsorted municipal waste stream. Any batteries must be removed from the device and disposed of separately before disposing of the device. At all times dispose of this product and its batteries according to local regulations.

Recycling Assistance

The device should be recycled according to national and local regulations. Contact your local Physio-Control representative for assistance or refer to www.physio-control.com/recycling.

Preparation

The device should be clean and contaminant-free prior to being recycled.

Recycling of Disposable Electrodes

After using disposable electrodes, follow your local clinical procedures for recycling.

Packaging

Packaging should be recycled according to national and local regulations.

Warranty

To obtain a detailed warranty statement, contact your local Physio-Control representative or go to www.physio-control.com.

Using defibrillation electrodes, adapter devices, or other parts and supplies from sources other than Physio-Control is not recommended. Physio-Control has no information regarding the performance or effectiveness of its LIFEPAK defibrillators if they are used in conjunction with defibrillation electrodes or other parts and supplies from other sources. If device failure is attributable to defibrillation electrodes or other parts or supplies not manufactured by Physio-Control, this may void the warranty.

Accessories

The following table lists accessories that are available for the LIFEPAK 15 monitor/defibrillator. To order, contact your Physio-Control representative. In the USA, call Customer Support at 1.800.442.1142, option 2.

Note: The LIFEPAK 15 monitor/defibrillator and its accessories that are intended for direct or casual contact with the patient are not made with natural rubber latex.

Table 38 Accessories for the LIFEPAK 15 Monitor/Defibrillator

CATEGORY	RELATED ACCESSORY
Power	Lithium-ion battery Station Lithium-ion Battery Charger Mobile Lithium-ion Battery Charger REDI-CHARGE Battery Charger AC Power Adapter for use with the LIFEPAK 15 monitor/defibrillator DC Power Adapter for use with the LIFEPAK 15 monitor/defibrillator Power adapter output extension cable Power adapter attachment kit
Therapy	QUIK-COMBO pacing/defibrillation/ECG electrodes QUIK-COMBO RTS pacing/defibrillation/ECG electrodes QUIK-COMBO RTS Pediatric pacing/defibrillation/ECG electrodes QUIK-COMBO pacing/defibrillation/ECG electrodes with REDI-PAK preconnect system QUIK-COMBO Therapy cable Standard paddles Pediatric paddles Internal paddles Internal paddles adapter cable
Monitoring:	
ECG	Cleartrace™ ECG electrodes (Conmed) 3-lead ECG cable 5-wire ECG cable 12-lead ECG cable (includes main 4-wire cable and precordial lead attachment)
SpO ₂ – Masimo	RC-4 patient cable (4 ft) RC-12 patient cable (12 ft) RC-4 EMS patient cable (4 ft) Red LNC patient cable (4, 10, 14 ft) Patient extension cables Red™ LNOP® and LNCS™ Reusable LNCS and M-LNCS sensors Disposable LNCS and M-LNCS sensors
SpO ₂ – Nellcor	Masimo Red™ MNC patient cable (for use with Nellcor sensors) Reusable Oximax DS-100A sensor Dura-Y™ multisite sensor Oxiband reusable sensor, Adult/Neonatal Sensor Extension Cable (4, 8 ft)

CATEGORY	RELATED ACCESSORY
SpCO and SpMet – Masimo	Rainbow patient extension cables Rainbow reusable sensors Rainbow disposable sensors Rainbow light shields
NIBP	NIBP reusable blood pressure cuffs (Statcorp Medical) NIBP disposable blood pressure cuffs (Statcorp Medical) NIBP hoses
EtCO ₂ – Oridion	EtCO ₂ FilterLine sets EtCO ₂ Smart CapnoLine [®] lines
Temperature	Measurement Specialties disposable temperature probes: 4491 Esophageal/Rectal, 4499HD Skin High Dielectric, 4464 Foley 14Fr, 4466 Foley 16Fr, 4468 Foley 18Fr Temperature probe adapter cable
Other accessories	Wireless modem/gateway Bed connector LIFEPAK monitor to PC cable (serial communication cable) PC-based configuration tool Test Load 3-Lead ECG patient simulator 12-Lead ECG patient simulator SIGNAGEL [®] electrode gel ECG recording paper, 100 mm wide

Specifications and Performance Characteristics

This appendix contains the specifications and performance characteristics for the LIFEPAK 15 monitor/defibrillator and the LIFEPAK 15 monitor/defibrillator batteries. It also lists high and low alarm limits, alarm performance characteristics, and factory default settings.

Specifications and Performance Characteristics

Table, LIFEPAK 15 Monitor/Defibrillator Specifications, lists the LIFEPAK 15 monitor/defibrillator specifications for the device.

Table, Battery Specifications (on page 244), lists the specifications for the LIFEPAK 15 monitor/defibrillator batteries.

Table, Alarm Limits, lists the high and low limits for alarms when either the wide or narrow alarm setting is selected on the LIFEPAK 15 monitor/defibrillator.

Table, Alarm Performance Characteristics (on page 248), lists the alarm performance characteristics.

Table, Setup Options Factory Default Settings (on page 250), lists the factory default settings for the LIFEPAK 15 monitor/defibrillator setup options.

Table 39 LIFEPAK 15 Monitor/Defibrillator Specifications

CHARACTERISTIC	DESCRIPTION
All specifications are at 20°C unless otherwise stated.	
GENERAL	
Classification	Monitor/defibrillator— Battery powered and Class II (per IEC 60601-1)
	Applied parts—ECG, Internal Defibrillation, Invasive Pressure and Temperature have Type CF patient connections. External Defibrillation, CO2, SpO2, and NIBP have Type BF patient connections (per IEC 60601-1).
Modes	AED mode—for automated ECG analysis and a prompted treatment protocol for patients in cardiac arrest. Manual mode—for performing manual defibrillation, synchronized cardioversion, noninvasive pacing, and ECG and vital sign monitoring. Archive mode—for accessing stored patient information. Setup mode—for changing default settings of the operating functions. Service mode—for authorized personnel to perform diagnostic tests and calibrations. Demo mode—for simulated waveforms and trend graphs for demonstration purposes.
Self-test	When powered on, the device performs a self-test to check internal electrical components and circuitry. A service indicator is illuminated if an error is detected. The device also performs an auto test daily. Results are printed and stored in the device log. Auto test results can be transmitted. See the <i>LIFEPAK 15 Monitor/Defibrillator Setup Options</i> provided with your device for more information.
Continuous Patient Surveillance System (CPSS)	In Advisory Monitoring, CPSS monitors the patient ECG, via QUIK-COMBO® electrodes or Lead II, for a potentially shockable rhythm.
Voice Prompts	Manual mode: Used for selected prompts (selectable ON/OFF) AED mode: Used for entire AED protocol

Specifications and Performance Characteristics

Analog ECG Output	Output: 1 volt/mV Frequency Response: 0.67 to 32 Hz (except 2.5 to 25 Hz for Paddles ECG and 1.3 to 23 Hz for 1–30 Hz Monitor Frequency Response) No internal pacemaker pulse enhancements or detection markers included. Pace markers during external pacing using this device are included.			
Notch Filter	50 or 60 Hz			
POWER				
Batteries	Rechargeable Lithium-ion battery Dual battery capability with automatic switching Low battery indication and message: Low battery fuel gauge indication and low battery message in status area for each battery Replace battery indication and message: Replace battery fuel gauge indication, audio tones, and replace battery message in the status area for each battery. When replace battery is indicated, device auto-switches to second battery. When both batteries reach replace battery condition, a voice prompt instructs user to replace battery. Input voltage range is between +8.8 and +12.6 Vdc			
Battery Capacity	For two, new fully-charged batteries, 20°C (68°F): Capacity to shutdown is:			
	Operating Mode	Monitoring (minutes)	Pacing (minutes)	Defibrillation (360J discharges)
	Typical	360	340	420
	Minimum	340	320	400
	Capacity after low battery is:			
	Typical	21	20	30
	Minimum	12	10	6
AC Power Adapter	AC-DC power adapter Input power range is 100-240 Vac, 50/60 Hz, 1.4-0.6 A Output voltage is 12 Vdc Meets UL 60601-1 300 microampere Earth leakage limit when installed on a center-tapped, 240 Vac, single phase circuit.			
DC Power Adapter	DC-DC power adapter Input power range is: Minimum: 11 Vdc, 15 A Nominal: 13.8 Vdc, 12.5 A Maximum: 17.6 Vdc, 10 A Output voltage is 12 Vdc			
Device Behavior when using Power Adapter	Auxiliary power indicator on defibrillator illuminated when connected to auxiliary power. Battery charging indicator illuminated when batteries are fully charged and flashing if either battery is being charged. Battery status indicators on display show battery charge level, but well number is not highlighted because battery is not in use. Low battery and replace battery prompts and messages do not occur.			

Appendix A | Specifications and Performance Characteristics

PHYSICAL	
Weight	Basic monitor/defibrillator with new roll paper and two batteries installed: 7.9 kg (17.5 lb)
	Fully featured monitor/defibrillator with new roll paper and two batteries installed: 8.4 kg (18.5 lb)
	Lithium-ion battery: < 0.60 kg (1.3 lb)
	Accessory bags and shoulder strap: 1.77 kg (3.9 lb)
	Standard (hard) paddles: 0.95 kg (2.1 lb)
Height	31.7 cm (12.5 in)
Width	40.1 cm (15.8 in)
Depth	23.1 cm (9.1 in)
DISPLAY	
Size (active viewing area)	212 mm (8.4 in) diagonal; 171 mm (6.7 in) wide x 128 mm (5.0 in) high
Display Type	640 dot x 480 dot color backlit LCD
	User selectable display mode (full color or SunVue™ high contrast)
	Displays a minimum of 5 seconds of ECG and alphanumerics for values, device instructions, or prompts
	Displays up to three waveforms
	Waveform display sweep speed: 25 mm/sec for ECG, SpO ₂ , IP, and 12.5 mm/sec for CO ₂
DATA MANAGEMENT	
	The device captures and stores patient data, events (including waveforms and annotations), and continuous waveform and patient impedance records in internal memory.
	The user can select and print reports, and transfer the stored information via supported communication methods.
Report Types	Three format types of CODE SUMMARY™ critical event record: short, medium, and long
	12-lead ECG with STEMI statements
	Continuous Waveform (transfer only)
	Trend Summary
	Vital Sign Summary
	Snapshot
Memory Capacity	Total capacity is 360 minutes of continuous ECG, 90 minutes of continuous data from all channels, or 400 single waveform events. Maximum memory capacity for a single patient includes up to 200 single waveform reports and 90 minutes of continuous ECG.

Specifications and Performance Characteristics

COMMUNICATIONS

The device is capable of transferring data records by wired or wireless connection. This device complies with Part 15 of the FCC rules, and its operation is subject to the following two conditions: (1) this device may not cause harmful interference, and (2) this device must accept any interference received, including interference that may cause undesired operation.

Serial Port RS232 communication
+12V available

Bluetooth[®] technology *Bluetooth* technology provides short-range wireless communication with other *Bluetooth*-enabled devices. The *Bluetooth* transceiver complies with *Bluetooth* Class 1 frequency, power, and bandwidth requirements.

MONITOR

ECG ECG is monitored via several cable arrangements. A 3-wire cable is used for 3-lead ECG monitoring. A 5-wire cable is used for 7-lead ECG monitoring. A 10-wire cable is used for 12-lead ECG acquisition. When the chest electrodes are removed, the 10-wire cable functions as a 4-wire cable. Standard paddles or QUIK-COMBO pacing/defibrillation/ECG electrodes are used for paddles lead monitoring.

Frequency Response Monitor—0.5 to 40 Hz or 1 to 30 Hz
Paddles—2.5 to 30 Hz
12-lead ECG diagnostic—0.05 to 150 Hz

Lead Selection Leads I, II, III (3-wire ECG cable)
Leads I, II, III, AVR, AVL, and AVF acquired simultaneously (4-wire ECG cable)
Leads I, II, III, AVR, AVL, AVF, and C lead acquired simultaneously (5-wire ECG cable)
Leads I, II, III, AVR, AVL, AVF, V1, V2, V3, V4, V5, and V6 acquired simultaneously (10-wire ECG cable)

ECG Size 4, 3, 2.5, 2, 1.5, 1, 0.5, 0.25 cm/mV (fixed at 1 cm/mV for 12-lead)

Leads Off Sensing The ECG leads off function uses AC current at 20 kHz for sensing leads off, the disposable defibrillation electrodes use AC current at 20 kHz for leads off, and the ECG leads use a noise cancelation signal which ranges from DC to approximately 5 kHz. The amplitude of these signals conforms to IEC 60601-1 Clause 8.7.3.

Heart Rate Display 20–300 bpm digital display
Accuracy: $\pm 4\%$ or ± 3 bpm, whichever is greater

Recovery Time after Defibrillation 10 seconds

Heart Rate Averaging Method The heart rate average is formed by a weighted average of approximately 8 seconds duration. When the input rate is trending rapidly, the rate meter will track more quickly. Refer to heart rate response time disclosure. The display update interval is every heartbeat or every 2 seconds, whichever is shorter.

Heart Rate Step Response Time 80 bpm to 120 bpm input step change: ≤ 10 seconds to indicate a minimum of 100 bpm.
80 bpm to 40 bpm input step change: ≤ 10 seconds to indicate a maximum of 60 bpm.

Appendix A | Specifications and Performance Characteristics

Heart Rate with Irregular Rhythm	<p>The rate meter output can range from the heart rate associated with the shortest R-R interval to the heart rate associated with the longest R-R interval. When present, intermediate length R-R intervals are favored as the basis for the rate.</p> <p>When evaluated per IEC 60601-2-27, rates are as follows:</p> <ul style="list-style-type: none"> • A1. Ventricular bigeminy: HR = 80 to 86 • A2. Slow alternating ventricular bigeminy: HR = 60 to 63 • A3. Rapid alternating ventricular bigeminy: HR = 123 to 124 • A4. Bidirectional systoles: HR = 97 to 99
QRS Detection Range	<p>Duration: 40 to 120 msec Amplitude: 0.5 to 5.0 mV Tall T-wave Rejection: T-waves that are 1 mV high are not detected by the monitor when the R-wave size is 1 mV and input rate is 80 ppm.</p>
Common Mode Rejection (CMRR)	ECG Leads: 90 dB at 50/60 Hz
Pacemaker Pulse Rejection	<p>Rejects pacemaker pulses having amplitudes from ± 2 mV to ± 700 mV and pulse widths from 0.1 ms to 2.0 ms with and without overshoot. Pacemaker pulse overshoot is defined as 2.5% to 25% of the pacemaker pulse amplitude not to exceed 2 mV. Refer to IEC 60601-2-27.</p> <p>Note: Does not apply when internal paddles are connected.</p>
SpO₂/SpCO/SpMet	
Sensors	<p>Masimo® sensors including Rainbow® sensors Nellcor® sensors when used with the Masimo Red™ MNC adapter</p>
SpO₂	
Displayed Saturation Range	"<50" for levels below 50%; 50 to 100%
Saturation Accuracy is specified for range 70-100% (0-69% is not specified).	
Adults/Pediatrics Accuracy (RMS)*	<p>$\pm 2\%$ (during no motion conditions - Masimo) $\pm 3\%$ (during no motion conditions - Nellcor) $\pm 3\%$ (during motion conditions - Masimo)</p>
Neonatal Accuracy (RMS)*	<p>$\pm 3\%$ (during no motion conditions - Masimo) $\pm 4\%$ (during no motion conditions - Nellcor) $\pm 3\%$ (during motion conditions - Masimo)</p>
Dynamic signal strength bar graph	
Pulse tone as SpO ₂ pulsations are detected	
SpO ₂ Averaging Time	User selectable: 4, 8, 12 or 16 seconds
SpO ₂ Data Update Period	1 second
SpO ₂ Alarm Condition Delay	21 seconds (maximum time from physiological change to detection by device, with default 8 second averaging selected)
SpO ₂ Alarm Signal Generation Delay	1 second (time for device to generate alarm after alarm condition is detected)
SpO ₂ Sensitivity	User selectable: Normal, High
SpO ₂ Measurement	Functional SpO ₂ values are displayed and stored

Specifications and Performance Characteristics

Pulse Rate Accuracy (specified for range 25 to 240 bpm)	
Adults/Pediatrics (RMS)	±3% (during no motion conditions) ±5% (during motion conditions)
Optional SpO ₂ waveform display with autogain control	
SpCO™	
SpCO Concentration Display Range	0 to 40%
SpCO Accuracy (RMS)*	±3% (during no motion conditions)
SpMet™	
SpMet Saturation Range	0 to 15.0%
SpMet Display Resolution	0.1% up to 10%
SpMet Accuracy (RMS)*	±1% (during no motion conditions)
*Because the above SpO ₂ , SpCO, and SpMet measurements are statistically distributed, only about two-thirds of the measurements can be expected to fall within the accuracies specified above.	
Note: A functional tester cannot be used to assess SpO ₂ accuracy. See IEC 80601-2-61 Annex FF.	
SpO ₂ Measurement Wavelengths	
Note: Information about wavelength range can be useful to clinicians, for example, when performing photodynamic therapy.	
Masimo (SpO ₂ only)	Red: 660 nanometers Infrared: 905 nanometers
Nellcor (SpO ₂ only)	Red: 660 nanometers Infrared: 900 nanometers
SpO ₂ Optical Power	
Masimo	Maximum optical output power = 15 mW (SpO ₂ only) Maximum optical output power for Rainbow sensor (SpO ₂ , SpCO, SpMet) = 25 mW
Nellcor	Maximum optical output power = 15 mW (SpO ₂ only)
NIBP	
Blood Pressure	Systolic Pressure Range: 30 to 255 mmHg Diastolic Pressure Range: 15 to 220 mmHg Mean Arterial Pressure Range: 20 to 235 mmHg Units: mmHg in increments of 1 mmHg Blood Pressure Accuracy: ±5 mmHg Blood Pressure Measurement Time: 20 seconds, typical (excluding cuff inflation time)
Pulse Rate	Pulse Rate Range: 30 to 240 pulses per minute Pulse Rate Accuracy: ±2 pulses per minute or ±2%, whichever is greater
Operation Features	Initial Cuff Pressure: User selectable, 80 to 180 mmHg Automatic Measurement Time Interval: User selectable
Automatic Cuff Deflation	Excessive Pressure: If cuff pressure exceeds 290 mmHg Excessive Time: If measurement time exceeds 120 seconds

Appendix A | Specifications and Performance Characteristics

Validation	The NIBP monitor performance was clinically validated according to the requirements of ISO 81060-2.	
CO ₂		
CO ₂ Range	0 to 99 mmHg (0 to 13.2 kPa) Units: mmHg, %, or kPa	
CO ₂ Accuracy*	CO ₂ partial pressure at sea level:	Accuracy:
(0–80 bpm)**	0 to 38 mmHg (0 to 5.1 kPa)	±2 mmHg (0.27 kPa)
	39 to 99 mmHg (5.2 to 13.2 kPa)	±5% of reading + 0.08% for every 1 mmHg (0.13 kPa) above 38 mmHg (5.1 kPa)
(>80 bpm)	0 to 18 mmHg (0 to 2.4 kPa)	±2 mmHg (0.27 kPa)
	19 to 99 mmHg (2.55 to 13.3 kPa)	±4 mmHg (0.54 kPa) or ±12% of reading, whichever is higher
	*Determined by the methods in ISO 21647 clauses 51.101.1 and 51.101.2.	
	**For RR > 60 bpm, to achieve specified CO ₂ accuracy, the Microstream® FilterLine® H Set for infant must be used.	
	The accuracy specifications listed above are maintained within an additional 4% in the presence of interfering gases defined in ISO 80601-2-55.	
Respiration Rate Accuracy	0 to 70 bpm: ±1 bpm 71 to 99 bpm: ±2 bpm	
Respiration Rate Range	0 to 99 breaths/minute	
Flow Rate	50 ml/min -7.5, +15 ml/min (flow measured by volume)	
Rise Time	190 msec	
Response Time	4.3 seconds maximum with 200 cm FilterLine tubing 5.9 seconds maximum with 400 cm FilterLine tubing (includes delay time and rise time)	
Initialization Time	30 seconds (typical), 10-180 seconds	
Ambient Pressure	Automatically compensated internally	
Optional Display Waveform	CO ₂ pressure	
Scale Factors	Autoscale, 0–20 mmHg (0–4 Vol%), 0–50 mmHg (0–7 Vol%), 0–100 mmHg (0–14 Vol%)	
Waveform Sample Rate	20/sec or one sample every 50 msec	
CO ₂ Calculation	Per 80601-2-55, Method for End-tidal CO ₂ calculation: EtCO ₂ is a maximum rather than average value. The accuracy of the CO ₂ readings and respiration rates was tested with a CO ₂ square wave simulator.	
Measurement Drift	The periodic autozero function compensates for drifts between components, and changes in ambient temperature and barometric conditions. This automatic process eliminates variances that might otherwise cause measurement drift. Therefore, the CO ₂ function does not exhibit drift.	

Specifications and Performance Characteristics

INVASIVE PRESSURE	
Transducer Type	Strain-gauge resistive bridge
Transducer Sensitivity	5 μ V/V/mmHg required
Defibrillation Protection	Minimum 360 J defibrillation protection required in the transducer
Excitation Voltage	5 Vdc
Connector	Electro Shield CXS 3102A 14S-6S
Bandwidth	Digital filtered, DC to 30 Hz (< -3db)
Zero Drift	1 mmHg/hr without transducer drift
Zero Adjustment	\pm 150 mmHg including transducer offset
Numeric Accuracy	\pm 1 mmHg or 2% of reading, whichever is greater, plus transducer error
Pressure Range	-30 to 300 mmHg, in six user selectable ranges
Invasive Pressure Display	Display: IP waveform and numerics Units: mmHg Labels: P1 or P2, ART, PA, CVP, ICP, LAP (user selectable)
TEMPERATURE	
Sensors	Measurement Specialties 4400 series esophageal/rectal and Foley catheter temperature probes, and 4499HD skin temperature probe
Displayed Range	24.8° to 45.2°C (76.6° to 113.4°F)
Resolution	0.1°C
Accuracy	\pm 0.2°C
Labels	Temp, T-esoph, T-naso, T-bladder, T-rectal, T-skin
Update Rate	Every 10 seconds, minimum
Mode of Operation	Direct mode
Adapter Cable	Only use Physio-Control part number 3303935
Cable Length	1.5 or 3 m (5 or 10 ft)
TREND	
Time Scale	Auto, 30 minutes, 1, 2, 4, or 8 hours
Duration	Up to 8 hours
ST	After initial 12-lead ECG analysis, automatically selects and trends ECG lead with the greatest ST displacement
Display	Choice of HR, PR (SpO ₂), PR (NIBP), SpO ₂ (%), SpCO(%), SpMet(%), CO ₂ (EtCO ₂ /FICO ₂), RR (CO ₂), NIBP, IP1, IP2, TEMP, ST
INTERPRETIVE ALGORITHM	12-Lead Interpretive Algorithm: University of Glasgow 12-Lead ECG Analysis Program, includes AMI and STEMI statements
ALARMS	
Quick Set	Activates alarms for all active vital signs
VF/VT Alarm	Activates continuous CPSS monitoring in Manual mode
No Breath Alarm	Occurs when 30 seconds has elapsed since last detected respiration
Heart Rate Alarm Limit Range	Upper, 100–250 bpm; lower, 30–150 bpm

Appendix A | Specifications and Performance Characteristics

PRINTER

Prints continuous strip of the displayed patient information and reports	
Paper Size	100 mm (3.9 in)
Print Speed	25 mm/sec or 12.5 mm/sec Optional 50 mm/sec time base for 12-lead ECG reports
Delay	8 seconds
Autoprint	Waveform events print automatically
Frequency Response	Diagnostic—0.05 to 150 Hz or 0.05 to 40 Hz Monitor—0.67 to 40 Hz or 1 to 30 Hz

DEFIBRILLATOR

Charge Time (per IEC 60601-2-4)

AC Operation Only:

Maximum Time from Charge to Shock Ready (Manual Mode):

Voltage	Charge Time
90-240 Vac	360 J within 10 seconds

Maximum Time from Initiation of Analysis to Shock Ready (AED Mode):

Voltage	Charge Time
90-240 Vac	360 J within 30 seconds

Maximum Time from Power-on to Shock Ready (Manual Mode):

Voltage	Charge Time
90-240 Vac	360 J within 25 seconds

Maximum Time from Power-on to Shock Ready (AED Mode):

Voltage	Charge Time
90-240 Vac	360 J within 40 seconds

DC Operation Only:

Maximum Time from Charge to Shock Ready (Manual Mode):

Voltage	Charge Time
11-17.6 Vdc	360 J within 10 seconds

Maximum Time from Initiation of Analysis to Shock Ready (AED Mode):

Voltage	Charge Time
11-17.6 Vdc	360 J within 30 seconds

Maximum Time from Power-on to Shock Ready (Manual Mode):

Voltage	Charge Time
11-17.6 Vdc	360 J within 25 seconds

Maximum Time from Power-on to Shock Ready (AED Mode):

Voltage	Charge Time
11-17.6 Vdc	360 J within 40 seconds

Specifications and Performance Characteristics

Battery Operation Only:

Maximum Time from Charge to Shock Ready (Manual Mode):

Battery Status	Charge Time
Fully charged	200 J within 7 seconds, nominal
Fully charged, followed by 15 full-energy shocks	360 J within 10 seconds
Fully charged	360 J within 10 seconds

Maximum Time from Initiation of Analysis to Shock Ready (AED Mode):

Battery Status	Charge Time
Fully charged	200 J within 15 seconds, nominal
Fully charged, followed by 15 full-energy shocks	360 J within 30 seconds
Fully charged	360 J within 30 seconds

Maximum Time from Power-on to Shock Ready (Manual Mode):

Battery Status	Charge Time
Fully charged, followed by 15 full-energy shocks	360 J within 25 seconds

Maximum Time from Power-on to Shock Ready (AED Mode):

Battery Status	Charge Time
Fully charged, followed by 15 full-energy shocks	360 J within 40 seconds

Manual Mode

Energy Select	2, 3, 4, 5, 6, 7, 8, 9, 10, 15, 20, 30, 50, 70, 100, 125, 150, 175, 200, 225, 250, 275, 300, 325, and 360 joules
Synchronous cardioversion	The maximum time delay between synchronization pulse and the delivery of energy, once the output has been activated, is not more than 60 msec. This time delay is measured from the peak of the QRS to the peak of the defibrillator waveform.
Paddles Lead Off Sensing	When using QUIK-COMBO electrodes, the device indicates Paddles Leads Off if the resistive part of the patient impedance is greater than $300 \pm 15\% \Omega$, or if the magnitude of the patient impedance is greater than $440 \pm 15\% \Omega$.
Biphasic Waveform	Biphasic Truncated Exponential The following specifications apply from 25 to 200Ω , unless otherwise specified: Energy Accuracy: ± 1 joule or 10% of setting, whichever is greater, into 50Ω ; ± 2 joules or 15% of setting, whichever is greater, into 25-175 Ω . Voltage Compensation: Active when disposable therapy electrodes are attached. Energy output within $\pm 5\%$ or ± 1 joule, whichever is greater, of 50Ω value, limited to the available energy which results in the delivery of 360 joules into 50Ω .

Waveform Shape and Measured Parameters

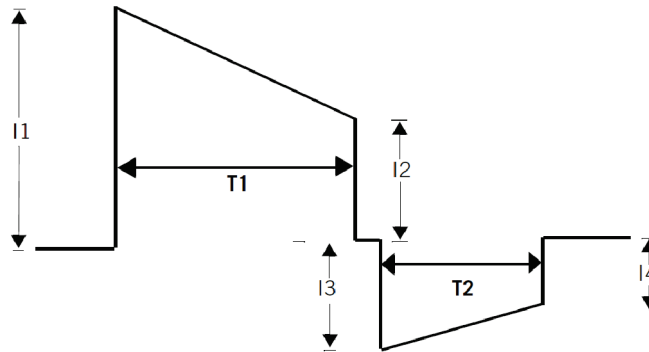

Biphasic Waveform

Patient Impedance (Ω)	Phase 1 Duration (ms)		Phase 2 Duration (ms)		Tilt (%)		Delivered Energy
	Min	Max	Min	Max	Min	Max	
25	5.1	6.0	3.2	4.2	69.9	85.2	352
50	6.8	7.9	4.4	5.5	57.0	74.7	360
75	7.6	9.4	4.9	6.5	49.3	67.6	349
100	8.7	10.6	5.6	7.3	43.0	62.2	332
125	9.5	11.2	6.2	7.7	39.0	56.6	316
150	10.1	11.9	6.6	8.2	36.8	52.6	301
175	10.6	12.5	6.9	8.6	33.8	49.3	287
200	10.9	13.4	7.1	9.2	29.6	47.4	274

Rated Energy Output

Rated energy output is the nominal delivered energy based on the energy setting and patient impedance, as defined in the following chart.

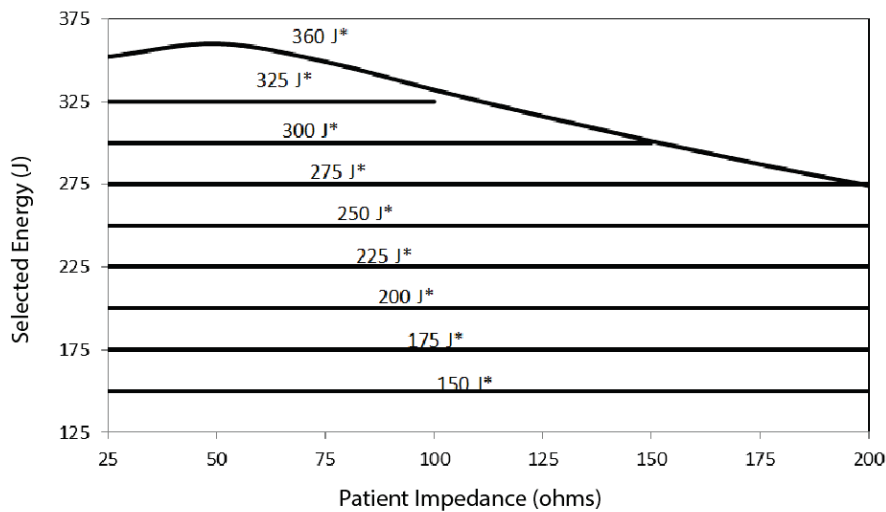

*Energy setting selected

Specifications and Performance Characteristics

Paddle Options	QUIK-COMBO pacing/defibrillation/ECG electrodes (standard) Standard paddles (optional)
Cable Length	8 foot long (2.4 m) QUIK-COMBO cable (not including electrode assembly)
AED Mode	Shock Advisory System (SAS) is an ECG analysis system that advises the operator if the algorithm detects a shockable or nonshockable ECG rhythm. SAS acquires ECG via therapy electrodes only.
Biphasic Output Energy	Shock levels ranging from 150–360 joules with same or greater energy level for each successive shock
cprMAX™ Technology	In AED mode, cprMAX technology provides a method of maximizing the CPR time that a patient receives, with the overall goal of improving the rate of survival of patients treated with AEDs
Setup Options:	
Auto Analyze	Allows for auto analysis. Options are OFF, AFTER 1ST SHOCK
Initial CPR	Allows the user to be prompted for CPR for a period of time prior to other activity. Options are OFF, ANALYZE FIRST, CPR FIRST
Initial CPR Time	Time interval for Initial CPR. Options are 15, 30, 45, 60, 90, 120, and 180 seconds
Pre-Shock CPR	Allows the user to be prompted for CPR while the device is charging. Options are OFF, 15, 30 seconds
Pulse Check	Allows the user to be prompted for a pulse check at various times. Options are ALWAYS, AFTER SECOND NSA, AFTER EVERY NSA, NEVER
Stacked Shocks	Allows for CPR after 3 consecutive shocks or after a single shock. Options are OFF, ON
CPR Time 1 or 2	User selectable times for CPR. Options are 15, 30, 45, 60, 90, 120, 180 seconds and 30 minutes
PACER	
Pacing Mode	Demand or nondemand Rate and current defaults
Pacing Rate	40 to 170 PPM
Rate Accuracy	±1.5% over entire range
Output Waveform	Monophasic, truncated exponential current pulse (20 ±1 msec)
Output Current	0 to 200 mA Pause: Pacing pulse frequency reduced by a factor of 4 when activated
Output Current Accuracy	± 10% or 5 mA (whichever is greater) over the specified load impedance range
Refractory Period	180 to 270 msec (function of rate)
Physio-Control Therapy Electrode Post-Pacing Performance per IEC 60601-2-4	After pacing: AC large signal impedance ≤ 4.2 Ω DC offset voltage ≤ 1053 mV After pacing followed by 360 J shock: DC offset voltage ≤ 1228 mV, 4 seconds after shock DC offset voltage ≤ 966 mV, 60 seconds after shock

Appendix A | Specifications and Performance Characteristics

ENVIRONMENTAL—Unit meets functional requirements during exposure to the following environments unless otherwise stated.

Operating Temperature	0° to 45°C (32° to 113°F) -20°C (-4°F) for 1 hour after storage at room temperature 60°C (140°F) for 1 hour after storage at room temperature
Storage Temperature	-20° to 65°C (-4° to 149°F) except therapy electrodes and batteries When a device stored at -20°C (-4°F) is placed at room temperature, it is ready for use after 2 hours. When a device stored at 65°C (149°F) is placed at room temperature, it is ready for use after 2 hours.
Relative Humidity, Operating	5 to 95%, non-condensing NIBP: 15 to 95%, non-condensing
Relative Humidity, Storage	10 to 95%, non-condensing
Atmospheric Pressure, Operating	-382 to 4,572 m (-1,253 to 15,000 ft) NIBP: -152 to 3,048 m (-500 to 10,000 ft)
Water Resistance, Operating	IP44 (dust and splash resistance) per IEC 60529 and EN 1789 (without accessories except for 12-lead ECG cable, hard paddles, and battery pack)
Vibration	MIL-STD-810E Method 514.4 Propeller Aircraft - category 4 (figure 514.4-7 spectrum a) Helicopter - category 6 (3.75 Grms) Ground Mobile - category 8 (3.14 Grms) EN 1789: Sinusoidal Sweep, 1 octave/min, 10-150 Hz, ±0.15 mm/2 g
Shock (drop)	5 drops on each side from 18 inches onto a steel surface EN 1789: 30-inch drop onto each of 6 surfaces
Shock (functional)	Meets IEC 60068-2-27 and MIL-STD-810E shock requirements 3 shocks per face at 40 g, 6 ms half-sine pulses
Bump	1000 bumps at 15 g with pulse duration of 6 msec
Impact, Non-operating	IEC 60601-1 0.5 + 0.05 joule impact UL 60601-1 6.78 Nm impact with 2-inch diameter steel ball Meets IEC 62262 protection level IK04
EMC	IEC 60601-1-2 Medical Equipment - General Requirements for Safety - Collateral Standard: Electromagnetic Compatibility - Requirements and Tests
Cleaning	Cleaning 20 times with the following: Quaternary ammonium, isopropyl alcohol, hydrogen peroxide
Chemical Resistance	60 hour exposure to specified chemicals: Betadine (10% Povidone-Iodine solution) Coffee, Cola Dextrose (5% Glucose solution) Electrode Gel/Paste (98% water, 2% Carbopol 940) HCL (0.5% solution, pH=1) Isopropyl Alcohol NaCl solution (0.9% solution) Cosmetic discoloration of the paddle well shorting bar shall be allowed following exposure to HCL (0.5% solution).

Specifications and Performance Characteristics

ESSENTIAL PERFORMANCE

The LIFEPAK 15 monitor/defibrillator includes the following essential performance features:

- Defibrillation, Synchronized Cardioversion, and AED Shock Advisory System
- ECG Monitoring, Heart Rate, and Alarms
- SpO₂ Monitoring, Pulse Rate, and Alarms
- EtCO₂ Monitoring and Alarms
- NIBP Monitoring and Alarms
- Invasive Pressure Monitoring and Alarms
- Temperature Monitoring and Alarms

Table 40 Battery Specifications

CHARACTERISTIC	DESCRIPTION
Battery Type	Lithium-ion
Weight	< 0.60 kg (1.3 lb)
Charge Time (with fully depleted battery)	< 190 minutes (typical)
Battery indicators	Each battery has a fuel gauge that indicates its approximate charge. A fuel gauge that shows two or fewer LEDs after a charge cycle indicates that the battery should be replaced.
Charging Temperature Range	5° to 45°C (41° to 113°F)
Operating Temperature Range	0° to 45°C (32° to 113°F)
Short Term (<1 week) Storage Temperature Range	-20° to 60°C (-4° to 140°F)
Long Term (>1 week) Storage Temperature Range	20° to 25°C (68° to 77°F)
Operating and Storage Humidity Range	5 to 95% relative humidity, non-condensing

Table 41 Heart Rate Alarm Limits

PARAMETER	LOW	HIGH
Default Heart Rate (HR) or Pulse Rate (PR) Alarm Limits*	50	150
HR or PR Alarm Limits Range	30-150	100-250
Patient HR or PR <60 bpm		
Quick Set Wide Limits**	-20	+35
Quick Set Narrow Limits**	-10	+25
Patient HR or PR 60-79 bpm		
Quick Set Wide Limits**	-25	+40
Quick Set Narrow Limits**	-20	+30
Patient HR or PR 80-104 bpm		
Quick Set Wide Limits**	-30	+40
Quick Set Narrow Limits**	-30	+30
Patient HR or PR ≥105 bpm		
Quick Set Wide Limits**	-35	+45
Quick Set Narrow Limits**	-25	+25

*Default limits are established when alarms are set up to be ON.

**Numbers are ± from patient's VS value when the alarms are set.

Table 42 SpO₂ Alarm Limits

PARAMETER	LOW	HIGH
Default SpO ₂ Alarm Limits*	85	100
SpO ₂ Alarm Limits Range	50	90-100
Patient SpO ₂ (%) ≥90		
Quick Set Wide Limits**	-5	+3
Quick Set Narrow Limits**	-5	+3
Patient SpO ₂ (%) <90		
Quick Set Wide Limits**	-5	+3
Quick Set Narrow Limits**	-5	+3

*Default limits are established when alarms are set up to be ON.

**Numbers are ± from patient's VS value when the alarms are set.

Table 43 Blood Pressure Alarm Limits

PARAMETER	LOW	HIGH
Default Systolic BP Alarm Limits*	50	200
Systolic Alarm Limits Range	30	245
Patient Systolic BP <90 mmHg		
Quick Set Wide Limits**	-20	+35
Quick Set Narrow Limits**	-10	+25
Patient Systolic BP 90-114 mmHg		
Quick Set Wide Limits**	-20	+35
Quick Set Narrow Limits**	-10	+25
Patient Systolic BP 115-140 mmHg		
Quick Set Wide Limits**	-25	+35
Quick Set Narrow Limits**	-10	+20
Patient Systolic BP >140 mmHg		
Quick Set Wide Limits**	-25	+35
Quick Set Narrow Limits**	-10	+20
Default Diastolic BP Alarm Limits**		
Diastolic Alarm Limits Range	12	210
Patient Diastolic BP <65 mmHg		
Quick Set Wide Limits**	-15	+25
Quick Set Narrow Limits**	-10	+25
Patient Diastolic BP 65-90 mmHg		
Quick Set Wide Limits**	-15	+15
Quick Set Narrow Limits**	-15	+10
Patient Diastolic BP >90 mmHg		
Quick Set Wide Limits**	-15	+15
Quick Set Narrow Limits**	-15	+10

*Default limits are established when alarms are set up to be ON.

**Numbers are ± from patient's VS value when the alarms are set.

Specifications and Performance Characteristics

Table 44 Capnography Alarm Limits

PARAMETER	LOW	HIGH
Default EtCO ₂ Alarm Limits (mmHg/%)*	15/2.0	50/6.6
EtCO ₂ Alarm Limits Range (mmHg/%)	5/0.7	70/9.2
Patient EtCO ₂ >40 mmHg/5.3%		
Quick Set Wide Limits**	-10/-1.3	+15/+2.0
Quick Set Narrow Limits**	-10/-1.3	+15/+2.0
Patient EtCO ₂ ≤40 mmHg/5.3%		
Quick Set Wide Limits**	-10/-1.3	+15/+2.0
Quick Set Narrow Limits**	-10/-1.3	+15/+2.0
Default Inspired CO ₂ Alarm Limits (mmHg/%)*	N/A	8/1.1
Inspired CO ₂ Alarm Limits Range (mmHg/%)	N/A	0/0–10/1.3
Patient Inspired CO ₂ (mmHg/%)		
Quick Set Wide Limits**	N/A	+5/+0.7
Quick Set Narrow Limits**	N/A	+3/+0.4
Default Respiration Rate (RR) Alarm Limits*	5	30
RR Alarm Limits Range	5-15	10-60
Patient RR <15		
Quick Set Wide Limits**	-8	+8
Quick Set Narrow Limits**	-4	+4
Patient RR ≥15		
Quick Set Wide Limits**	-15	+15
Quick Set Narrow Limits**	-8	+8

*Default limits are established when alarms are set up to be ON.

**Numbers are ± from patient's VS value when the alarms are set.

Table 45 Invasive Pressure Alarm Limits

PARAMETER	LOW	HIGH
Default Systolic PA Alarm Limits*	10	40
Systolic PA Alarm Limits Range	10	100
Patient Systolic PA <15 mmHg		
Quick Set Wide Limits**	-6	+12
Quick Set Narrow Limits**	-4	+6
Patient Systolic PA 15-35 mmHg		
Quick Set Wide Limits**	-8	+16
Quick Set Narrow Limits**	-6	+8
Patient Systolic PA >35 mmHg		
Quick Set Wide Limits**	-12	+16
Quick Set Narrow Limits**	-8	+10
Default Diastolic PA Alarm Limits	0	18
Diastolic PA Alarm Limits Range	0	50
Patient Diastolic PA <5 mmHg		

Appendix A | Specifications and Performance Characteristics

PARAMETER	LOW	HIGH
Quick Set Wide Limits**	-4	+12
Quick Set Narrow Limits**	-4	+8
Patient Diastolic PA 5-13 mmHg		
Quick Set Wide Limits**	-4	+16
Quick Set Narrow Limits**	-6	+6
Patient Diastolic PA >13 mmHg		
Quick Set Wide Limits**	-6	+16
Quick Set Narrow Limits**	-6	+6
Default CVP Alarm Limits*	0	15
CVP Alarm Limits Range	0	25
Patient CVP ≥9 mmHg		
Quick Set Wide Limits**	-10	+10
Quick Set Narrow Limits**	-5	+5
Default ICP, LAP Alarm Limits*	0	18
ICP, LAP Alarm Limits Range	0	40
Patient ICP, LAP <15 mmHg		
Quick Set Wide Limits**	-6	+6
Quick Set Narrow Limits**	-4	+4
Patient ICP, LAP ≥15 mmHg		
Quick Set Wide Limits**	-6	+8
Quick Set Narrow Limits**	-4	+6

*Default limits are established when alarms are set up to be ON.

**Numbers are ± from patient's VS value when the alarms are set.

Table 46 Temperature Alarm Limits

PARAMETER	LOW	HIGH
Default Temperature Alarm Limits (°C)*	35	39
Temperature Alarm Limits Range	31	41
Patient Temperature ≥31°C		
Quick Set Wide Limits**	-3	+3
Quick Set Narrow Limits**	-1	+1

*Default limits are established when alarms are set up to be ON.

**Numbers are ± from patient's VS value when the alarms are set.

Table 47 Alarm Performance Characteristics

CHARACTERISTIC	DESCRIPTION
Heart Rate Alarm Time	<p>For a 1 mV, 206 bpm tachycardia, the average detection time was 4.6 seconds.</p> <p>For a test signal half as large, the average was 4.1 seconds. In this case the device sensitivity was increased to 5mV/cm.</p> <p>For a test signal twice as large, the average was 3.1 seconds.</p> <p>For a 2 mV, 195 bpm tachycardia, the average detection time was 2.5 seconds.</p> <p>For a test signal half as large, the average was 2.2 seconds. In this case the device sensitivity was increased to 5mV/cm.</p> <p>For a test signal twice as large, the average was 1.5 seconds.</p>
Audible Alarms	<p>This is a standalone device. All alarm tones are internal to the LIFEPAK 15 monitor/defibrillator. The alarm tone volumes range from 45 to 85 dB.</p> <p>Alarm violations are manifested by tones, voice prompts, and visual indications.</p> <p>Alarm manifestation occurs within 1 second after a displayed parameter violates its alarm limit. User selectable alarm volume adjustment is provided. This adjustment does not allow alarm volume to attain/reach a zero level.</p> <p>SAS tones reinforce SAS messages provided on the product display.</p> <p>The following identifies the tone assignments for each type of alarm:</p> <ul style="list-style-type: none"> • The priority 1 tone is used to alert the user to the possibility of death. This tone is a 440 Hz and 880 Hz alternating tone with a 50% duty cycle and a 4 Hz alternation frequency. This tone has a volume of 70 ±5 dB (A) as measured at a distance of 1 meter from the display. The volume of the priority 1 alarm is not adjustable. • The priority 2 tone (the Quick Set alarm tone) is used to alert the user that a possible life-threatening condition exists. This tone is a continuous 698 Hz tone. This tone has a volume that is lower than the priority 1 tone. • The priority 3 tone is used to alert the user that an abnormal condition exists. Three beeps at 1046 Hz for 100 ms duration each with a 150 ms silence between the first and second and the second and third, followed by a 200 ms silence. This tone has a volume that is lower than the priority 2 tone. • Priority 3 tones come in single and repeating types: for a single tone, the 3-beep sequence sounds only once. For a repeating tone, the 3-beep sequence sounds every 20 seconds. • The priority 4 tone is a momentary tone between 500 and 1500 Hz. This tone has a volume that is lower than the priority 3 tone. Specific characteristics are: <ul style="list-style-type: none"> – QRS and Volume Setting Tone—100 msec duration at 1397 Hz— 4 msec duration at 1319 Hz. <p>The alert tone shall consist of one set of two tones to precede voice prompts and to draw attention to the display. Specific characteristics consist of:</p> <ul style="list-style-type: none"> • 1000 Hz square wave, 100 ms duration • Silence, 100 msec duration • 1000 Hz square wave, 100 ms duration • Silence, 140 msec duration (when preceding a voice prompt) • Voice prompt, when used

CHARACTERISTIC	DESCRIPTION
Visual Alarms	<p>Alarms are indicated visually by:</p> <ul style="list-style-type: none"> • The violated parameter flashes in inverse video with a message in the message area of the display. • These visual indications remain on the display until the alarm is corrected. Visual indication of alarms continue even when the tones have been silenced.
Priorities for Alarm Conditions	<p>Alarm conditions have the following priorities.</p> <p>Priority 1:</p> <ul style="list-style-type: none"> • VF or VT detected based on ECG signal <p>Priority 2:</p> <ul style="list-style-type: none"> • Heart rate high or low limit exceeded • SpO₂ high or low limit exceeded • NIBP high or low limit exceeded • Invasive pressure high or low limit exceeded • EtCO₂ high or low limit exceeded • FiCO₂ high limit is exceeded • Respiration rate high or low limit exceeded • No breath detected • Temperature high or low limit exceeded <p>Priority 3:</p> <ul style="list-style-type: none"> • ECG leads off detected • Low battery (5-15% capacity) detected • Very low battery (<5% capacity) detected <p>Note: For this condition, the priority 3 tone is followed by the REPLACE BATTERY prompts.</p> <ul style="list-style-type: none"> • Service condition that could prevent normal operation detected.

Specifications and Performance Characteristics

Table 48 Setup Options Factory Default Settings

MENU	MENU/ITEM	FACTORY DEFAULT SETTINGS	
General	Language	(Country Specific)	
	Code Summary	Long	
	Trend Summary	Off	
	Site Number	000	
	Device ID	"LP15" + last 4 digits of serial number, for example, LP151234	
	Auto Log	On	
	Line Filter	60 Hz	
	Timeout Speed	30 seconds	
Manual mode	Sync After Shock	Off	
	Pads Default	200 (joules)	
	Energy Protocol	Inactive	
	Internal Default	10 (joules)	
	Voice Prompts	On	
	Shock Tone	On	
	Manual Access	Manual / Direct	
	Set Passcode	0000	
AED mode	Energy Protocol	200–300–360	
	Auto Analyze	Off	
	Motion Detection	On	
	Pulse Check	Never	
	CPR	CPR Time 1	120 seconds
		CPR Time 2	120 seconds
		Initial CPR	Off
		Initial CPR Time	120 seconds
Preshock CPR		Off	
CPR Metronome	Metronome	On	
	Adult - No Airway	30:2	
	Adult - Airway	10:1	
	Youth - No Airway	15:2	
	Youth - Airway	10:1	
Pacing	Rate	60 PPM	
	Current	0 mA	
	Mode	Demand	
	Internal Pacer	Detection Off	

Appendix A | Specifications and Performance Characteristics

MENU	MENU/ITEM	FACTORY DEFAULT SETTINGS	
Monitoring	Channels	Default Set	Set 1
	Set 1	Channel 1	ECG Lead II
		Channel 2	None
		Channel 3	None
	Continuous Data	ECG Channel 1	
	SpO ₂ Tone	Off	
	CO ₂	Units	mmHg
		BTPS	Off
	NIBP	Initial Pressure	160 mmHg
		Interval	Off
	Temperature	Units	Celsius
	Trends	On	
	12-Lead	Auto Transmit	Off
Auto Print		On	
Print Speed		25 mm/sec	
Interpretation		On	
Format		3-Channel Standard	
Events	Events Page 1	Event 2	Oxygen
		Event 3	IV Access
		Event 4	Nitroglycerin
		Event 5	Morphine
		Event 6	Cancel Last
		Event 7	Intubation
		Event 8	CPR
		Event 9	Epinephrine
		Event 10	Atropine
		Event 11	Lidocaine
		Events Page 2	Event 12
	Event 13		Heparin
	Event 14		Thrombolytic
	Event 15		Glucose
	Event 16		Naloxone
	Event 17		Transport
	Event 18		Adenosine
	Event 19		Vasopressin
	Event 20		Amiodarone
	Event 21		Dopamine
	Event 22		Bicarb

Specifications and Performance Characteristics

MENU	MENU/ITEM	FACTORY DEFAULT SETTINGS	
Alarms	Volume	5	
	Alarms	Off	
	VF/VT Alarm	Off	
Printer	Auto Print	Defibrillation	On
		Pacing	Off
		Check Patient	Off
		SAS	Off
		Patient Alarms	Off
		Events	Off
		Initial Rhythm	Off
	ECG Mode	Monitor	
	Monitor Mode	1–30 Hz	
	Diagnostic Mode	.05–40 Hz	
	Alarm Waveforms	On	
	Event Waveforms	On	
	Vitals Waveforms	Off	
Transmission	Sites	Site 1 / Output Port / Direct Connect	
	Default Site	None	
	Default Report	12-Lead	
	Wireless	On	
	Search Filter	Off	
Clock	Date/Time	Current date/time PST	
	Clock Mode	Real Time	
	DST	Off	
	Time Zone	None	
Self Test	Transmit Results	Off	
Service	Maintenance Prompt Interval	Off	

Screen Messages

This appendix describes the screen messages that the LIFEPAK 15 monitor/defibrillator may display during normal operation.

Summary of Screen Messages

Table 49 Summary of Screen Messages

MESSAGE	DESCRIPTION
12-LEAD STOPPED	A 12-lead was requested but was stopped by the device.
12-LEAD ECG UNAVAILABLE	A 12-lead was requested but the necessary ECG data is not available.
ABNORMAL ENERGY DELIVERY	A discharge occurred when the paddles were shorted together, when hard paddles did not have adequate contact with the patient or were discharged in the air, or patient impedance was out of range. Message may also appear in certain types of internal faults.
ACCESS DENIED	Three consecutive incorrect passcode attempts were made to enter Manual mode.
ACQUIRING 12-LEAD	Monitor is acquiring data for 12-lead ECG report.
ACQUIRING SNAPSHOT	A snapshot report of current vital signs has been requested.
ADVISORY MODE-MONITORING	The device is monitoring the patient ECG for a shockable rhythm.
ADVISORY: SPCO > 10%	SpCO advisory alert activated. SpCO value is greater than 10%.
ADVISORY: SPMET > 3%	SpMet advisory alert activated. SpMet value is greater than 3%.
ALARM NO BREATH	No valid breath has been detected for 30 seconds.
ALARMS SILENCED	Alarms are silenced. An alert tone with status message ALARMS SILENCED occurs periodically as a reminder.
ANALYZING 12-LEAD	The data for 12-lead ECG report is being analyzed.
ANALYZING NOW-STAND CLEAR	The AED is analyzing the patient ECG rhythm.
ATTEMPTING TO TRANSMIT	The device is processing a transmission request.
AUTO NIBP CANCELLED	The automatic initiation of NIBP measurements has been cancelled.
BATTERY X LOW	The specified battery has a low energy condition.
BLUETOOTH DEVICE NOT FOUND	<i>Bluetooth</i> device has not been detected.
BLUETOOTH UNAVAILABLE	Unable to locate or connect to target device.
CANNOT CHARGE	CHARGE is pressed and the synchronize source is missing for synchronized cardioversion, the therapy cable is not connected, or QUIK-COMBO electrodes are not attached to the therapy cable.
CANNOT CHARGE BATTERIES	Both batteries are installed, and the device is unable to charge either battery.
CANNOT CHARGE BATTERY 1	The device is unable to charge the battery in battery well 1.
CANNOT CHARGE BATTERY 2	The device is unable to charge the battery in battery well 2.
CHARGING TO XXX J	Appears when CHARGE is pressed on the front panel or standard paddles.
CHECK FOR PULSE	AED prompt after each standard 3-shock sequence or NO SHOCK ADVISED message.

Summary of Screen Messages

MESSAGE	DESCRIPTION
CHECK PATIENT!	A potentially shockable rhythm has been detected when the VF/VT alarm is on.
CHECK PATIENT. IF NO PULSE, PUSH ANALYZE	A potentially shockable rhythm has been detected when using Advisory Monitoring.
CHECK PRINTER	The printer door is open, there is no paper in the printer, or another printer malfunction exists.
CO2 AUTOZERO	EtCO ₂ monitor is automatically performing a zero-point calibration.
CO2 FILTERLINE BLOCKAGE	EtCO ₂ FilterLine tubing is kinked or clogged; the message appears after 30 seconds of unsuccessful purging.
CO2 FILTERLINE OFF	EtCO ₂ FilterLine tubing is disconnected or is not securely connected to the device.
CO2 FILTERLINE PURGING	EtCO ₂ FilterLine tubing is kinked or clogged with liquid.
CO2 INITIALIZING	EtCO ₂ monitor is performing a self-check.
CONNECT CABLE	Therapy cable is not connected when you press CHARGE , PACER , or ANALYZE .
CONNECT CHEST LEADS	A 12-lead ECG analysis was requested and precordial leads are not connected to the patient.
CONNECT ECG LEADS	ECG electrodes or leads are disconnected.
CONNECT ELECTRODES	Therapy electrodes are disconnected.
CONNECTED TO	The device is connected via <i>Bluetooth</i> technology to another <i>Bluetooth</i> -enabled device. The name of the connected device follows this message.
CONNECTING TO	The device is establishing communication with another <i>Bluetooth</i> -enabled device. The name of the target device follows this message.
CPR: ADULT-AIRWAY X:Y	An option for CPR metronome. The patient is an adult for whom an advanced airway has been established. The specified C:V ratio will be used.
CPR: ADULT-NO AIRWAY X:Y	An option for CPR metronome. The patient is an adult for whom an advanced airway has not been established. The specified C:V ratio will be used.
CPR: YOUTH-AIRWAY X:Y	An option for CPR metronome. The patient is a youth (younger than the age of puberty) for whom an advanced airway has been established. The specified C:V ratio will be used.
CPR: YOUTH-NO AIRWAY X:Y	An option for CPR metronome. The patient is a youth (younger than the age of puberty) for whom an advanced airway has not been established. The specified C:V ratio will be used.
CURRENT FAULT	The comparison between delivered and selected pacing current is out of tolerance.
DEMAND	Pacemaker is in Demand mode.
DEMO MODE	The device is in Demo mode and simulated patient data is displayed.
DISARMING...	The energy charge is being removed internally.
ECG CABLE OFF	The device is printing and the ECG cable is removed.
ECG LEADS OFF	Multiple ECG electrodes are disconnected.
ENDING DEVICE SEARCH	The request for finding a <i>Bluetooth</i> device was stopped.

MESSAGE	DESCRIPTION
ENERGY DELIVERED	Energy transfer is complete.
ENERGY FAULT	The comparison between stored and selected energy is out of tolerance.
ENTER MANUAL MODE?	One of the Manual mode access buttons was pressed and the confirmation screen is set up to appear.
EXCESSIVE NOISE - 12-LEAD CANCELLED	Noise is detected for longer than 30 seconds that is too great to record a 12-lead ECG report.
IF NO PULSE, PUSH ANALYZE	Follows a CPR interval, if a PULSE CHECK setup option other than NEVER is selected.
IF NO PULSE, START CPR	Follows delivery of a shock or NO SHOCK ADVISED prompt, if a PULSE CHECK setup option other than NEVER is selected.
IF YOU WITNESSED THE ARREST, PUSH ANALYZE	Initial CPR message that follows START CPR prompt, to remind user to deliver a shock immediately if the user witnessed the arrest.
LA LEADS OFF	ECG electrode "LA" is disconnected.
LAST CONNECTED TO	When <i>Bluetooth</i> connectivity is installed and this device previously connected to a target device, the name of the target device appears after this message.
LL LEADS OFF	ECG electrode "LL" is disconnected.
LOST BLUETOOTH CONNECTION	Communication with <i>Bluetooth</i> device has been interrupted.
LOST DIRECT CONNECTION	Communication via direct connection has been interrupted.
MAINTENANCE DUE	Reminder message that appears at the interval that is set in Service mode. Message continues to appear until reset or turned off.
MANUAL MODE DISABLED	Access to Manual mode from AED mode has been restricted.
MOTION DETECTED!/STOP MOTION!	Motion was detected during ECG analysis.
NIBP AIR LEAK	NIBP cuff applied too loosely or there is a leak in cuff/monitor pneumatic system.
NIBP CHECK CUFF	NIBP cuff is not connected to patient or device.
NIBP FAILED	NIBP monitor cannot establish zero-pressure reference.
NIBP FLOW ERROR	NIBP pneumatic system is not maintaining stable cuff pressure.
NIBP INITIALIZING	NIBP requested while NIBP module is still initializing.
NIBP MOTION	Patient extremity moved too much for the NIBP monitor to accurately complete the measurement.
NIBP OVERPRESSURE	NIBP cuff pressure exceeded 290 mmHg.
NIBP TIME OUT	NIBP monitor did not complete a measurement in 120 seconds.
NIBP WEAK PULSE	The monitor did not detect any pulses.
NO SHOCK ADVISED	The defibrillator did not detect a shockable rhythm.
NO SITES DEFINED	Device is attempting to transmit using <i>Bluetooth</i> connection, but no associated destinations have been defined.
NOISY DATA! PRESS 12-LEAD TO ACCEPT	Monitor detects excessive signal interference while acquiring data. Press 12-LEAD to override the message and acquire 12-lead ECG with noise.

Summary of Screen Messages

MESSAGE	DESCRIPTION
NON-DEMAND	Pacemaker is in Nondemand (asynchronous) mode.
OBTAINING DEVICE NAMES	Device is obtaining names of available <i>Bluetooth</i> -enabled devices.
PACER FAULT	Internal error detected during pacing.
PACING IN PROGRESS	The requested action is not available because the device is currently performing pacing.
PACING STOPPED	Pacing has stopped—for example, due to disconnection of therapy electrodes.
PASSCODE INCORRECT - TRY AGAIN	Incorrect passcode entered.
PAUSED	The pacing PAUSE button is pressed and held. Current pulses are applied at reduced frequency while the MA and PPM settings are maintained.
PUSH ANALYZE	Press ANALYZE to begin ECG analysis.
PUSH AND HOLD SHOCK BUTTON!	The defibrillator is in Sync mode, fully charged, and ready to provide therapy.
PUSH AND HOLD PADDLE BUTTONS TO SHOCK!	The defibrillator is in Sync mode, fully charged, and ready to provide therapy with hard paddles connected.
PUSH SHOCK BUTTON!	The defibrillator is fully charged and ready to provide therapy.
PX NOT ZEROED	Transducer is connected or reconnected and is not zeroed.
PX TRANSDUCER NOT DETECTED	IP transducer is disconnected from the monitor/defibrillator.
PX ZERO FAILED	The device was unable to zero the pressure transducer.
PX ZEROED	Transducer successfully zeroed.
PX ZEROING	Monitor is establishing a zero reference.
RA LEADS OFF	ECG electrode "RA" is disconnected.
REPLACE BATTERY X	Power loss for the battery in well X is imminent.
SEARCHING FOR DEVICES	Device is attempting to identify available <i>Bluetooth</i> devices.
SELECT BIPHASIC ENERGY / XXX J	ENERGY SELECT was pressed on front panel or on standard paddles.
SELF TEST FAILED	Device detected internal error; remove device from service.
SELF TEST FAILED. TRANSMITTING...	Device detected internal error and is transmitting test results. Remove device from service after transmission is complete.
SELF TEST IN PROGRESS	Device is performing a self test after turning on.
SELF TEST PASSED	Device passed internal test and is available for use.
SELF TEST PASSED. TRANSMITTING...	Device passed internal test and is transmitting test results.
SHOCK ADVISED!	The defibrillator has analyzed the patient ECG rhythm and detected a shockable ECG rhythm.
SPCO: POOR QUALITY SIGNAL	Device is not receiving sufficient input from sensor.
SPMET: POOR QUALITY SIGNAL	Device is not receiving sufficient input from sensor.
SPO2: CHECK SENSOR	The SpO ₂ sensor connection to device or application to patient needs checked.
SPO2: LOW PERFUSION	Patient has a weak pulse.
SPO2: NO SENSOR DETECTED	A sensor is disconnected from the monitor.

MESSAGE	DESCRIPTION
SPO2: POOR QUALITY SIGNAL	Device is not receiving sufficient input from sensor.
SPO2: SEARCHING FOR PULSE	A sensor is connected to the patient and is searching for a pulse.
SPO2: SENSOR DOES NOT SUPPORT SPCO OR SPMET	The sensor in use only measures SpO ₂ .
SPO2: UNKNOWN SENSOR	A sensor that is not Physio-Control approved is connected to the device.
STAND CLEAR/PUSH SHOCK BUTTON	Prompts you to stand clear and push  (shock).
START CPR	Prompts you to begin providing CPR to the patient.
SWITCHING PRIMARY TO LEAD II	Pacing is turned on while PADDLES is the primary lead.
SWITCHING PRIMARY TO PADDLES	Device was in Lead II when ANALYZE was pressed. PADDLES becomes the primary lead.
SYNC MODE	Device is currently in Sync mode.
TEMP: ACCURACY OUTSIDE LIMITS	Temperature accuracy check has failed.
TEMP: CHECK SENSOR	Device is not receiving sufficient input from sensor.
TO CANCEL, PUSH SPEED DIAL	The defibrillator is charging or charged and the device may be disarmed by pressing the Speed Dial.
TRANSMISSION CANCELLED	Data transmission has been cancelled.
TRANSMISSION COMPLETED	Data transmission completed successfully.
TRANSMISSION FAILED	Data transmission was not successful.
TRANSMITTING TO <SITE>	Connection is established to <site> and transmission of requested report is occurring.
UNABLE TO CONNECT	Unable to establish connection with <i>Bluetooth</i> device.
UNABLE TO TRANSMIT	Unable to send data.
UNKNOWN DEVICE	<i>Bluetooth</i> connection failed or timed out before obtaining target device name.
USE ECG LEADS	Sync mode attempted, but ECG electrodes are not attached to patient, PADDLES lead is displayed, and standard paddles are connected to defibrillator.
USER TEST FAILED	Unsuccessful User Test.
USER TEST IN PROGRESS	USER TEST selected on the OPTIONS menu and test is in process.
USER TEST PASSED	Successful User Test completed.
VX LEADS OFF	ECG electrode such as "V1" is disconnected.
X DEVICES FOUND	Shows number of <i>Bluetooth</i> -enabled devices found.
XX LEADS OFF	ECG electrode such as "RA" is disconnected.
XX% TRANSMITTED	Specified percent of the transmission is completed.

Defibrillation Clinical Summaries

Defibrillation of Ventricular Fibrillation and Ventricular Tachycardia

Background

Physio-Control conducted a multi-centered, prospective, randomized and blinded clinical trial of biphasic truncated exponential (BTE) shocks and conventional monophasic damped sine wave (MDS) shocks. Specifically, the equivalence of 200 J and 130 J BTE shocks to 200 J MDS shocks¹ was tested.

¹ S.L. Higgins et al., "A comparison of biphasic and monophasic shocks for external defibrillation," *Prehospital Emergency Care*, 2000, 4(4):305-13.

Methods

Ventricular fibrillation (VF) was induced in 115 patients during evaluation of implantable cardioverter defibrillator function and 39 patients during electrophysiologic evaluation of ventricular arrhythmias. After 19±10 seconds of VF, a customized defibrillator delivered an automatically randomized shock. Efficacy was based on success of this shock. To demonstrate equivalence of test shocks to control shocks, the 95% upper confidence limit of the difference in efficacy (95UCLD), control minus test, was required to be less than 10%.

Results

Ventricular Fibrillation

The efficacy of the 200 J BTE shocks was demonstrated to be at least equivalent to the efficacy of 200 J MDS shocks (95UCLD=2%). The difference in success rates of 200 J MDS minus 200 J BTE shocks was -10% (exact 95% confidence interval from -27% to 4%). The 130 J BTE shocks were not demonstrated equivalent to 200 J MDS shocks (95UCLD=22%). However, neither was their efficacy significantly lower than that of the 200 J MDS shocks (statistical power limited by small sample sizes). For all shock types, hemodynamic parameters (oxygen saturation and systolic and diastolic blood pressure) were at or near their pre-induction levels by 30 seconds after successful shocks.

Ventricular Fibrillation 1st Shock Success

SHOCK	VENTRICULAR FIBRILLATION 1ST SHOCK SUCCESS	EXACT 95% CONFIDENCE INTERVAL
200 J MDS	61/68 (90%)	80-96%
200 J BTE	39/39 (100%)	91-100%
130 J BTE	39/47 (83%)	69-92%

Ventricular Tachycardia

Seventy-two episodes of ventricular tachycardia (VT), induced in 62 patients, were treated with randomized shocks. High rates of conversion were observed with biphasic and monophasic shocks. Sample sizes were too small to statistically determine the relationship between success rates of the waveforms tested.

Ventricular Tachycardia 1st Shock Success

SHOCK	VENTRICULAR TACHYCARDIA 1ST SHOCK SUCCESS	EXACT 95% CONFIDENCE INTERVAL
200 J MDS	26/28 (93%)	77-99%
200 J BTE	22/23 (96%)	78-100%
130 J BTE	20/21 (95%)	76-100%

Conclusions

In this double-blinded study, the efficacy of the 200 J BTE shocks was demonstrated to be at least equivalent to the efficacy of 200 J MDS shocks for defibrillation of short duration, electrically-induced VF. However, the comparison of efficacy of 130 J biphasic and 200 J monophasic shocks for VF was inconclusive. All waveforms tested provided a high rate of termination of VT. The VT sample sizes were too small to statistically determine the relationship between VT success rates of the waveforms tested.

Compared to conventional shocks for VF, we found no positive or negative effect of biphasic shocks for VF on hemodynamic parameters following the defibrillating shock. It is possible that, compared to 200 J monophasic shocks, 200 J biphasic shocks will in some cases enable earlier termination of VF. Therefore, we conclude that biphasic shocks for VF delivered at conventional energy levels have the potential to improve outcome in resuscitation of patients with cardiac arrest.

External Cardioversion of Atrial Fibrillation

Overview

The performance of the Physio-Control biphasic truncated exponential (BTE) waveform was compared to the conventional monophasic damped sine (MDS) waveform in an international, multi-center, prospective, randomized clinical study of adult patients undergoing elective cardioversion of atrial fibrillation (AF). A total of 80 patients were enrolled in the study and were treated with one or more study shocks. The primary dataset consisted of 72 enrolled patients confirmed to have been in AF. Data from seven patients with atrial flutter were analyzed separately. One patient who did not satisfy all protocol criteria was excluded from analysis.

Subjects were randomized to receive biphasic or monophasic shocks from LIFEPAK 12 defibrillator/monitors. Progressive shocks of 70, 100, 200 and 360 J of the assigned waveform, and a 360 J crossover shock of the other waveform, were delivered if AF persisted. Shocks were delivered using EDGE System QUIK-COMBO® Pacing/Defibrillation/ECG electrodes applied in the standard anterior-lateral position. Successful cardioversion was defined as the confirmed removal of AF after delivery of a shock, as determined by ECG over-read by two cardiologists with no knowledge of the shock waveform. Patients rated skin pain on a scale from 0 to 8 after the procedure.

This study showed that these biphasic shocks provide higher efficacy for cardioversion of atrial fibrillation, requiring fewer shocks, 65% less current and 65% less energy to cardiovert atrial fibrillation. Patients undergoing elective cardioversion with the biphasic protocol, as compared to those receiving the monophasic protocol, reported significantly less post-procedure pain.

Objectives

The primary objective of the study was to compare the cumulative efficacy of biphasic and monophasic shocks of 200 J or less for cardioversion of atrial fibrillation. A triangular sequential design was used to test for a statistically significant difference between groups of patients treated with these two waveforms.

Secondary objectives included 1) providing an estimation of the dose response relationship for the two waveforms which would allow clinicians to make well-informed selections of energy doses for cardioversion with biphasic shocks and 2) comparing the pain experienced by patients following treatment with monophasic and biphasic shocks.

Results

Seventy-two of the patients enrolled were in atrial fibrillation and 7 were in atrial flutter. On average, patients had been in atrial fibrillation for 88 days, were 66 years old, weighed 81 kg and had 72 ohms of transthoracic impedance. Sixty-three percent were male and 46% had been previously cardioverted. There were no significant differences between the groups of patients treated with monophasic and biphasic shocks, either in these baseline characteristics or in left atrial dimension, cardiac medications or diagnosis.

The cumulative success rates for cardioversion of atrial fibrillation are presented in the following table and the figure on the next page. These data provide a reasonable estimate of the expected

External Cardioversion of Atrial Fibrillation

probability of cardio-version success for a single shock at any given energy level within the range studied. Energy and peak current delivered for all shocks at each energy setting are presented in the following table.

Cumulative Success Rates and Crossover Results for Cardioversion of AF

ENERGY SETTING	70 J	100 J	200 J	360 J	360 J CROSSOVER SUCCESSES
MDS: <i>n</i> = 37	5.4%	19%	38%	86%	4 of 5 pts succeeded with 360 J BTE shock
BTE: <i>n</i> = 35	60%	80%	97%	97%	0 of 1 pts succeeded with 360 J MDS shock

Cumulative percentages of successes for cardioversion of AF with shocks of 200 J or less, the primary endpoint of the study, was significantly higher in the biphasic group than the monophasic group ($p < 0.0001$). The observed cumulative percentage of successes at 360 J was also higher for biphasic shocks than for monophasic shocks, but did not attain statistical significance.

Energy Settings, Delivered Energy and Peak Current for Shocks Delivered to Patients in AF

ENERGY SETTING	NUMBER OF PATIENTS	DELIVERED ENERGY	PEAK CURRENT, AMPS
Monophasic shocks			
70 J	37	73±3	21.0±3.5
100 J	35	105±4	24.6±4.3
200 J	30	209±7	34.6±5.9
360 J	23	376±13	46.8±8
360 J crossover shocks	1	380	44.7
Biphasic shocks ¹			
70 J	35	71±0	11.9±2.5
100 J	14	102±0	14.9 ±3.5
200 J	7	203±1	20.6±3.5
360 J	1	362	28.5
360 J crossover shocks	5	361±6	32.4±8.5

¹ Peak current and delivered energy are not available for two of the patients treated with biphasic shocks.

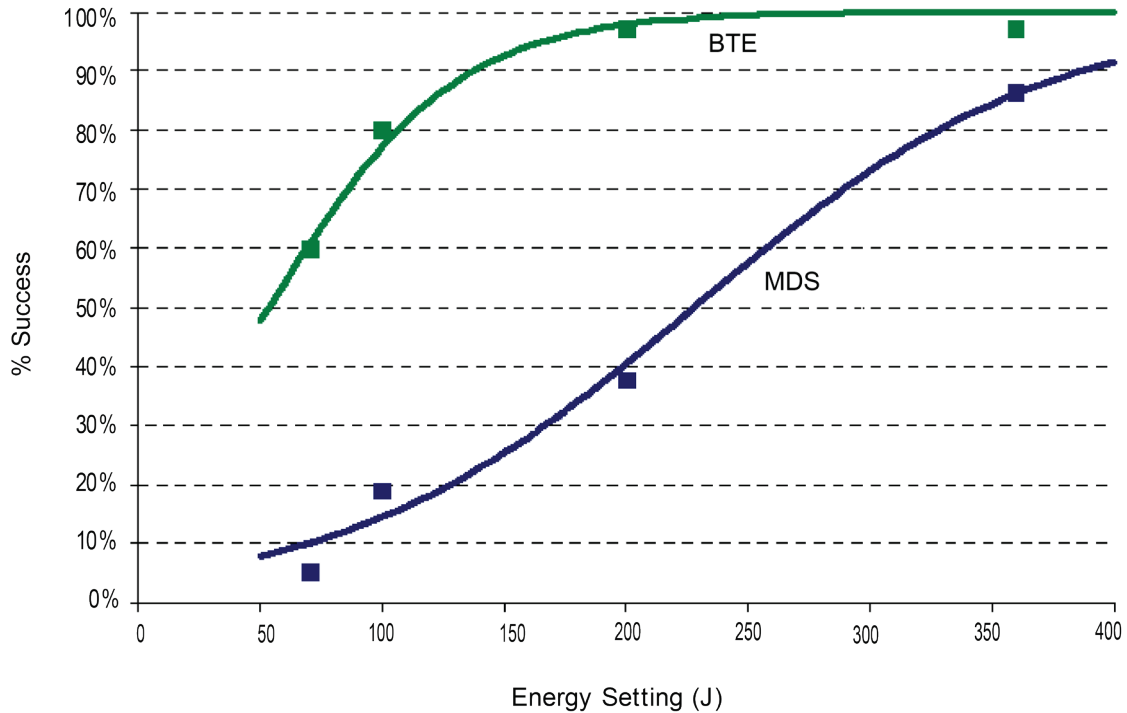

Figure 54 Cumulative Shock Success for Cardioversion of Atrial Fibrillation with Monophasic (MDS) and Biphasic (BTE) Shocks: Observed Rates (n) Plotted with Estimated Dose Response Curves

Compared to monophasic shocks, biphasic shocks cardioverted atrial fibrillation with less peak current (14.0 ± 4.3 vs. 39.5 ± 11.2 A, $p < 0.0001$), less energy (97 ± 47 vs. 278 ± 120 J, $p < 0.0001$), fewer shocks (1.7 vs. 3.5 shocks, $p < 0.0001$) and less cumulative energy (146 ± 116 vs. 546 ± 265 J, $p < 0.0001$). Patients treated with the biphasic protocol, as compared to those treated with the monophasic protocol, reported significantly less post-procedure pain just after (0.4 ± 0.9 vs. 2.5 ± 2.2 , $p < 0.0001$) and 24 hours after the procedure (0.2 ± 0.4 vs. 1.6 ± 2.0 , $p < 0.0001$).

All patients with atrial flutter were cardioverted with the first shock (70 J), whether that shock was monophasic (n=4) or biphasic (n=3).

Anterior-lateral electrode placement was used for treatment of most (96%) of the patients studied. Reports in the literature differ on whether anterior-posterior electrode placement provides better shock efficacy than anterior-lateral placement. If there is a benefit to anterior-posterior electrode placement, it may be possible to obtain modestly higher cardioversion success rates with both waveforms than those observed in this study. However, placement is not likely to affect the observed relationship between the efficacies of monophasic and biphasic waveforms.

Conclusions

The data demonstrate the Physio-Control biphasic waveform is clinically superior to the conventional monophasic damped sine waveform for cardioversion of atrial fibrillation. Specifically, compared to monophasic shocks, biphasic shocks cardioverted atrial fibrillation with less peak current, less energy, fewer shocks and less cumulative energy. Patients undergoing elective cardioversion with the biphasic protocol, as compared to those receiving the monophasic protocol, reported significantly less post-procedure pain just after and 24 hours after the procedure. This may be due to fewer required shocks, less cumulative energy, less delivered peak current or other characteristics of this biphasic waveform.

Guidance for Selection of Shock Energy

Biphasic waveform technology is a standard in cardiac defibrillators. The study summarized¹ here provides the best information available on which to base energy selections for cardioversion with this waveform.

For cardioversion of atrial fibrillation, the results of this study provide specific guidance for three possible strategies in selection of shock energy levels.

- To optimize for more rapid cardioversion and fewer shocks, select the same biphasic energy levels used previously with monophasic defibrillators (e.g., use 200 J biphasic instead of 200 J monophasic). This can be expected to increase the success rate yet decrease the peak current of the first and subsequent shocks.
- To maintain shock efficacy equivalent to that previously observed with monophasic shocks, select a biphasic energy level of about one-third the energy previously used for monophasic shocks (e.g., use 100 J biphasic instead of 300 J monophasic).
- To optimize for low initial and cumulative energy using a step-up protocol, select 70 J for the first shock and use small increases in energy if further shocks are needed.

Each of these strategies should provide effective cardioversion therapy while substantially reducing the amount of peak current to which the heart is exposed.

For cardioversion of atrial arrhythmias other than atrial fibrillation, the data available to guide the selection of energy settings is very limited. It is likely that biphasic doses below 50 J will provide high success rates when treating atrial flutter and paroxysmal supraventricular tachycardia. However, until more clinical data becomes available, it may be advisable to use the same energy settings for biphasic shocks as are customarily used for monophasic shocks.

Arrhythmias may persist for a variety of reasons unrelated to the type of waveform used for cardioversion. In persistent cases, clinicians continue to have the option to either increase shock intensity or switch to an alternate electrode placement.

¹ Koster R, Dorian P., et al. A randomized trial comparing monophasic and biphasic waveform shocks for external cardioversion of atrial fibrillation. *American Heart Journal*, 2004;147(5):K1-K7.

Intra-Operative Ventricular Defibrillation

Overview

The defibrillation efficacy of the Physio-Control biphasic truncated exponential (BTE) waveform was compared to the standard monophasic damped sine waveform (MDS) in a prospective, randomized multi-center study of patients undergoing intra-operative, direct defibrillation for ventricular fibrillation (VF). A total of 251 adult patients were enrolled in the study; 98 of these developed VF that was treated with one or more study shocks. Seven patients who did not satisfy all protocol criteria were excluded from analysis.

Subjects were randomized to receive BTE or MDS shocks from LIFEPAK 12 defibrillator/monitor. Those who developed VF after removal of the aortic clamp received progressively stronger shocks of 2, 5, 7, 10 and 20 joules (J) using 2-inch paddles until defibrillation occurred. A 20 J crossover shock of the alternate waveform was given if VF persisted.

This study showed that these biphasic shocks have higher defibrillation efficacy, requiring fewer shocks, less threshold energy and less cumulative energy than monophasic damped sine shocks.

Objectives

The primary objective of the study was to compare the cumulative efficacy of BTE shocks to MDS shocks at 5 J or less. A triangular sequential design was used to test for a difference between waveform groups.

The secondary objective was to provide an estimation of the dose response relationship for the two waveforms that would allow physicians to make well-informed selections of energy doses for intra-operative defibrillation with biphasic shocks.

Results

Thirty-five male and 15 female subjects were randomized to the BTE group; 34 and 7 to the MDS group. Mean age was 66 and 68 years, respectively. There were no significant differences between BTE and MDS treatment groups for cardiac etiology, arrhythmia history, current cardiac medications, American Society of Anesthesiology (ASA) risk class, left ventricular wall thickness, cardiopulmonary bypass time, core temperature or blood chemistry values at the time of aortic clamp removal.

Cumulative defibrillation success at 5 J or less, the primary endpoint of the study, was significantly higher in the BTE group than in the MDS group ($p=0.011$). Two of the 91 patients included in this primary endpoint analysis could not be included in more comprehensive analyses due to protocol variances that occurred in the shock sequence after the 5 J shock. Thus, the cumulative success rates for intra-operative defibrillation in the remaining 89 patients are presented in the following table and figure. These data provide a reasonable estimate of the expected probability of defibrillation success for a single shock at any given energy level within the range studied.

Compared to the MDS group, the BTE group required, on average, fewer shocks (2.5 vs. 3.5: $p=0.002$), less threshold energy (6.8 J vs. 11.0 J: $p=0.003$) and less cumulative energy (12.6 J vs.

23.4 J: $p=0.002$). There was no significant difference between success rates for BTE versus MDS crossover shocks.

Cumulative Shock Success Rates and Crossover Shock Results for Intra-operative Defibrillation

ENERGY SETTING	2 J	5 J	7 J	10 J	20 J	20 J CROSSOVER SUCCESSES
MDS: $n = 41$	7%	22%	34%	51%	76%	3 of 8 pts succeeded with 20 J BTE shock
BTE: $n = 48^1$	17%	52%	67%	75%	83%	3 of 8 pts succeeded with 20 J MDS shock

¹ Two subjects randomized to the BTE group were unable to be included in the cumulative success rates shown in the table and figure due to protocol deviations occurring after the 5 J shock.

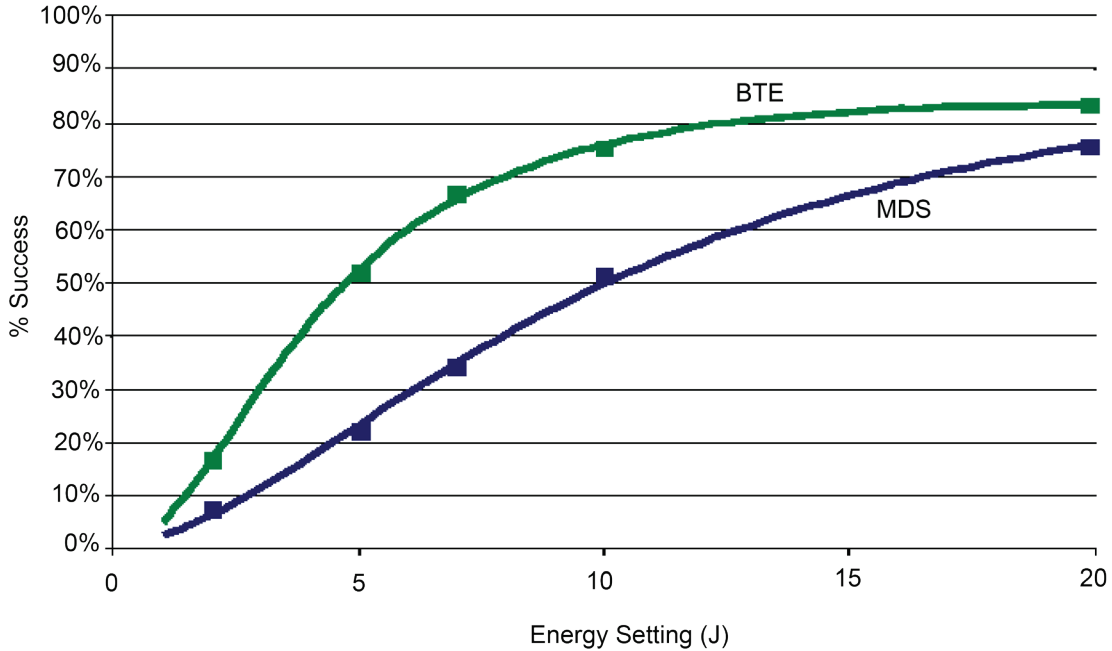

Figure 55 Cumulative Shock Success for Intra-operative Defibrillation with Monophasic (MDS) and Biphasic (BTE) Shocks: Observed Rates (n) Plotted with Estimated Dose Response Curves

Conclusions

The data demonstrate the Physio-Control biphasic waveform is clinically superior to the conventional monophasic damped sine waveform for intra-operative internal defibrillation of VF. Specifically, these biphasic shocks have higher defibrillation efficacy, while requiring fewer shocks, less threshold energy and less cumulative energy than monophasic damped sine shocks. There were no unsafe outcomes or adverse effects from the use of the biphasic waveform.

Guidance for Selection of Shock Energy

Biphasic waveform technology is a standard in cardiac defibrillators. The results of this study¹ provide specific guidance for three possible strategies in developing a dosing regimen.

- To optimize for lower initial and cumulative energy using a step-up protocol, select 5 J for the first shock and use small incremental increases in energy if further shocks are needed. In this study, biphasic shocks of 5 J were successful in approximately half of the patients.
- To optimize for more rapid defibrillation and fewer shocks, select the same BTE energy level used previously with MDS (e.g., 20 J BTE instead of 20 J MDS), which can be expected to increase the success rate yet decrease by approximately 30% the peak current of the first and subsequent shocks.
- To maintain an equivalent degree of efficacy as previously observed with MDS shocks, a BTE energy level one-half of that previously used for MDS shocks (e.g., 10 J BTE instead of 20 J MDS) would be an appropriate choice.

Each of these strategies should provide effective defibrillation therapy while substantially reducing the amount of peak current to which the heart is exposed.

Fibrillation may persist for a variety of reasons unrelated to the type of waveform used for defibrillation. In cases where fibrillation is persistent, physicians continue to have the option to either increase shock intensity or switch to a larger paddle size. Larger paddle size is known to decrease energy requirements for successful defibrillation.²

¹ B. Schwarz et al., Biphasic shocks compared with monophasic damped sine wave shocks for direct ventricular defibrillation during open heart surgery. *Anesthesiology*. 2003;98(5):1063-1069.

² Y. Zhang et al., "Open chest defibrillation: biphasic versus monophasic waveform shocks," *J Am Coll Cardiol*, 2001, 37(2 supplement A):320A.

Clinical Summary: Monophasic vs. Biphasic Waveforms: Out-of-Hospital Trial

Background

In a publication by Van Alem et al., the authors noted "Evidence suggests that biphasic waveforms are more effective than monophasic waveforms for defibrillation in out-of-hospital cardiac arrest (OHCA), yet their performance has only been compared in un-blinded studies."¹ The authors subsequently conducted and reported on a randomized clinical trial comparing the effectiveness of the LIFEPAK 500 defibrillation waveform (monophasic versus biphasic). Specifically, the success of biphasic truncated exponential (BTE) and monophasic damped sine wave (MDS) shocks for defibrillation were compared in a prospective, randomized, double-blinded clinical trial of out-of-hospital (OOH) cardiac arrest patients.

Note: The identical ECG analysis Shock Advisory System and BTE (ADAPTIV biphasic waveform) used in the LIFEPAK 500 AED is also used in the LIFEPAK CR Plus and LIFEPAK EXPRESS AEDs.

1 Van Alem AP, Chapman FW, Lank P, Hart AAM, Koster RW. A prospective, randomised and blinded comparison of first shock success of monophasic and biphasic waveforms in out-of-hospital cardiac arrest. Resuscitation 2003;58(1):17-24.

Methods

First responders were equipped with either a Physio-Control LIFEPAK 500 MDS or BTE (ADAPTIV biphasic waveform) AED in a random fashion. Patients in VF received BTE or MDS first shocks of 200 J. The ECG was recorded for subsequent analysis continuously. The success of the first shock as a primary endpoint was removal of VF and required a return of an organized rhythm for at least two (2) QRS complexes, with an interval of <5 seconds, within 1 minute after the first shock. The secondary endpoint was termination of VF at 5 seconds.

Results

VF was the initial recorded rhythm in 120 patients in OHCA, 51 patients received BTE and 69 received MDS shocks. The median time from collapse to first shock was 9 minutes for the monophasic shock and 11 minutes for the BTE. The success rate of 200 J first shocks was significantly higher for BTE than for MDS shocks, 35/51 (69%) and 31/69 (45%), $p=0.01$. Termination of VF at 5 seconds after the first shock was 91% for the monophasic shock and 98% for BTE waveform. Return of spontaneous circulation was 61% for the Physio-Control defibrillation shock.

In a logistic regression model, the odds ratio of success for a BTE shock was 4.01 (95% CI 1.01-10.0), adjusted for baseline cardiopulmonary resuscitation, VF-amplitude and time between collapse and first shock. No difference was found with respect to the secondary endpoint, termination of VF at 5 seconds (RR 1.07 95% CI: 0.99-1.11) and with respect to survival to hospital discharge (RR 0.73 95% CI:0.31-1.70).

Conclusion

The authors concluded that BTE-waveform AEDs provide significantly higher rates of successful defibrillation with return of an organized rhythm in OHCA than MDS waveform AEDs. This supports the safety and effectiveness of the LIFEPAK CR Plus and LIFEPAK EXPRESS AEDs.

Shock Advisory System

This appendix describes the basic function of the Shock Advisory System™ (SAS) algorithm.

Overview

The Shock Advisory System (SAS™) is an ECG analysis system built into the LIFEPAK 15 monitor/defibrillator that advises the operator whether it detects a shockable or nonshockable rhythm. This system makes it possible for individuals not trained to interpret ECG rhythms to provide potentially-lifesaving therapy to victims of ventricular fibrillation or pulseless ventricular tachycardia.

The Shock Advisory System contains the following features:

- Electrode Contact Determination
- Automated Interpretation of the ECG
- Operator Control of Shock Therapy
- Continuous Patient Surveillance System (CPSS)
- Motion Detection

The Shock Advisory System is active when the LIFEPAK 15 monitor/defibrillator is used as an automated external defibrillator (AED). CPSS may be activated during monitoring.

Upon the user pressing the ⚡ (shock) button, the LIFEPAK 15 monitor/defibrillator delivers the shock therapy to the patient.

Electrode Contact Determination

The Shock Advisory System measures the patient's transthoracic impedance through the therapy electrodes. If the baseline impedance is higher than a maximum limit, it determines that the electrodes do not have sufficient contact with the patient or are not properly connected to the AED. When this occurs, ECG analysis and shock delivery are inhibited. The AED advises the operator to connect electrodes when there is insufficient electrode contact.

Automated Interpretation of the ECG

The defibrillator recommends a shock if either of the following rhythms is detected:

- Ventricular fibrillation
- Rapid ventricular tachycardia

The defibrillator recommends no shock for nonshockable ECG rhythms as indicated in the Shock Advisory System Performance Report in this section.

The defibrillator is designed to detect and remove pacemaker pulses from the ECG so that an accurate decision can be reached while a pacemaker is functioning. Some pacemaker pulses may prevent advisement of an appropriate shock, regardless of the patient's underlying rhythm. If this occurs, the rescuer is advised to continue chest compressions.

Performance Verification

The Shock Advisory System (SAS) in the LIFEPAK 15 defibrillator was verified by inputting specific ECG waveform segments from Physio-Control databases through the electrode connector and recording the SAS decision of 'shock' or 'no shock.' The 'shock' or 'no shock' decision made by the SAS for each ECG waveform segment was compared to the treatment recommendation by clinical experts when they classified these individual ECG segments into rhythm groups and made a treatment recommendation of 'shock' or 'no shock.'

The main ECG database used to verify the performance of the LIFEPAK 15 defibrillator for SAS is named the *Physio-Control Test Set*. In addition, the ECG database named *SAS Test Set* was used to provide samples of shockable rapid ventricular tachycardia from pulseless patients for verification purposes. The following information about the test sets and the Summary Performance Report is provided in accordance with AHA recommendations¹ and IEC requirements² for reporting performance data for a rhythm recognition detector.

A. Acquisition and Annotation Methodology

This section includes recording methods, rhythm source, rhythm selection criteria, annotation methods, and annotation criteria for the Shock Advisory System test sets.

Physio-Control Test Set

The Physio-Control Test Set includes ECG segments gathered from a variety of sources. The test set includes both adult and pediatric ECG segments, ECGs from the standard anterior-lateral (AL, AA) defibrillation electrode placement, ECGs from anterior-posterior (AP) defibrillation electrode placement, and ECGs from patients who have a pacemaker. Each ECG segment is 10 seconds in duration. Sources for the ECGs include:

- AHA Ventricular Arrhythmia Database (Holter recordings)
- MIT-BIH Arrhythmia Database (Holter)
- MIT-BIH Malignant Ventricular Arrhythmia Database (Holter)
- Creighton University Ventricular Tachyarrhythmia Database (hospital monitor)
- A series of consecutive LIFEPAK 500 automated external defibrillator recordings collected by Physio-Control
- DiMarco AA-AP ECG Database (simultaneous AA and AP defibrillation leads, recorded in the electrophysiology laboratory)
- Vanderbilt Pediatric ECG Database (AA and/or AP defibrillation leads, recorded in the pediatric intensive care unit, the pediatric electrophysiology laboratory, and the pediatric operating room during open heart surgery)
- A series of 12-lead recordings from consecutive chest pain patients, recorded in the pre-hospital setting with the LIFEPAK 11 monitor/defibrillator.

SAS Test Set

The SAS Test Set includes 65 ECG samples of shockable rapid ventricular tachycardia from pulseless patients recorded during pre-hospital use of LIFEPAK 5 defibrillators by paramedics. Selected ECG segments were sampled and the ECG rhythm was classified by clinical experts. Each ECG segment is 5 seconds in duration.

B. ECG Rhythm Types

The ECG rhythms were placed into the following categories by the clinical experts.

Shockable

- Coarse ventricular fibrillation (VF) (≥ 0.20 mV peak-to-peak amplitude)
- Rapid ventricular tachycardia, pulseless (VT) (HR ≥ 120 bpm, QRS duration ≥ 160 ms, no apparent P waves, patient reported to be pulseless by paramedics)

Nonshockable

- Normal sinus rhythm (NSR) (sinus rhythm, heart rate 60-100 bpm)
- Asystole (< 0.08 mV peak-to-peak amplitude)
- Other organized rhythms including atrial fibrillation/flutter, atrioventricular block, idioventricular rhythms, sinus bradycardia, supraventricular tachycardia, and premature ventricular contractions

Intermediate

- Fine ventricular fibrillation (VF) (< 0.20 and ≥ 0.08 mV peak-to-peak amplitude)
- Other VT (ventricular tachycardia that does not meet criteria for VT in the shockable rhythms category)

Also included are coarse VF with pacemaker pulses and nonshockable rhythms with pacemaker pulses.

C. Summary Shock Advisory System Performance Report

The results of tests with the SAS and Physio-Control test sets in the LIFEPAK 15 defibrillator are shown below in the context of requirements from IEC 60601-2-4 and the recommendations from the American Heart Association.

IEC 60601-2-4 Requirements and SAS Performance for Adult and Pediatric Patients

RHYTHM CATEGORY	REQUIREMENT	TEST RESULT
<i>Shockable (Sensitivity)</i>		
Coarse VF	>90%	Met
Rapid VT, pulseless	>75%	Met
<i>Nonshockable (Specificity)</i>		
	>95%	Met
<i>Positive Predictive Value</i>	Report Only	>90%
<i>False Positive Rate</i>	Report Only	<5%

AHA Recommendations and SAS Performance for Adult Patients

RHYTHM CATEGORY	PERFORMANCE GOAL	MINIMUM SAMPLE SIZE	SAMPLE SIZE TESTED	TEST RESULT (GOAL AND SAMPLE SIZE)
<i>Shockable (Sensitivity)</i>				
Coarse VF	>90%	200	206	Met
Rapid VT, pulseless	>75%	50	65	Met
<i>Nonshockable (Specificity)</i>				
	>95%	300		Met
Normal Sinus Rhythm	>99%	100	509	Met
Other QRS	>95%	30	749	Met
Asystole	>95%	100	124	Met
<i>Intermediate</i>				
Fine VF	Report Only	25	32	>40% shocked
Other VT	Report Only	25	27	>20% shocked

SAS Performance for Pediatric Patients

RHYTHM CATEGORY	PERFORMANCE GOAL	SAMPLE SIZE TESTED	TEST RESULT (GOAL AND SAMPLE SIZE)
<i>Shockable (Sensitivity)</i> Coarse VF	>90%	63	Met
<i>Nonshockable (Specificity)</i> Normal Sinus Rhythm	>95%	69	Met
Other QRS	>99%	507	Met
Asystole	>95%	60	Met
<i>Intermediate</i> Fine VF	Report Only	1	>20% shocked

The Shock Advisory System was also tested using paced rhythms recorded at high-fidelity from patients with implanted pacemakers. The high-fidelity pacemaker spikes were also added to samples of ventricular fibrillation to test the defibrillator's ability to reach a shock decision in the case of ventricular fibrillation with an implanted, active pacemaker. The results are summarized in the following table.

Shock Advisory System Performance with Active Pacemakers

RHYTHM CATEGORY	PERFORMANCE GOAL	SAMPLE SIZE TESTED	TEST RESULT
<i>Shockable (Sensitivity)</i> Coarse VF	>90%	35	Met
<i>Nonshockable (Specificity)</i>	>95%	35	Met

Operator Control of Shock Therapy

The Shock Advisory System causes the AED to charge automatically when it detects the presence of a shockable rhythm. When a shock is advised, the operator presses the **SHOCK** button to deliver the energy to the patient.

Continuous Patient Surveillance System

The Continuous Patient Surveillance System (CPSS) automatically monitors the patient's ECG rhythm for a potentially shockable rhythm while the electrodes are attached and the AED is turned on. CPSS is not active during ECG analysis or when the AED is in a CPR cycle.

Motion Detection

The Shock Advisory System detects patient motion independent of ECG analysis. **MOTION DETECTION** can be set up to be **ON** or **OFF** in the Setup Options for the device.

A number of activities can create motion, including CPR, rescuer movement, patient movement, and vehicle movement. If variations in the transthoracic impedance signal exceed a maximum limit, the Shock Advisory System determines that patient motion of some kind is present. If motion is detected, the ECG analysis is inhibited. The operator is advised by a voice prompt. After 10 seconds, if motion is still present, the motion alert stops and the analysis always proceeds to completion. This limits the delay in therapy in situations where it may not be possible to stop the motion. However, the rescuer should remove the source of motion whenever possible to minimize the chance of artifact in the ECG.

There are two reasons why ECG analysis is inhibited when the motion alert occurs, and why the rescuer should remove the source of the motion whenever possible:

- Such motion may cause artifact in the ECG signal. This artifact may occasionally cause the Shock Advisory System to reach an incorrect decision.
- The motion may be caused by a rescuer's interventions. To reduce the risk of inadvertently shocking a rescuer, the motion alert prompts the rescuer to move away from the patient. This will stop the motion and ECG analysis will proceed.

Definitions and References

A true positive (A) is a correct classification of a shockable rhythm. A true negative (D) is a correct classifications of all rhythms for which a shock is not indicated. A false positive (B) is an organized or perfusing rhythm or asystole that has been incorrectly classified as a shockable rhythm. A false negative (C) is a VF or VT associated with cardiac arrest that has been incorrectly classified as non-shockable.

The sensitivity of the device for shockable rhythms is $A/(A+C)$. The true predictive value is expressed as $A/(A+B)$. The specificity of the device for non-shockable rhythms is $D/(B+D)$. The false positive rate is expressed as $B/(B+D)$.³

¹ Kerber RE, et al, "Automatic External Defibrillators for Public Access Defibrillation: Recommendations for Specifying and Reporting Arrhythmia Analysis Algorithm Performance, Incorporating New Waveforms, and Enhancing Safety: A Statement for Health Professionals from the American Heart Association Task Force on Automatic External Defibrillation", Subcommittee on AED Safety and Efficacy. *Circulation*, 1997: Vol. 95: 1677-1682.

² Clause 201.7.9.3.103, "Essential Performance data of the Rhythm Recognition Detector," International Electrotechnical Association, *IEC 60601-2-4, Medical Electrical Equipment – Part 2-4: Particular Requirements for the Basic Safety and Essential Performance of Cardiac Defibrillators: 2010*

³ Quoted from clause 201.107, "Requirements for Rhythm Recognition Detector," International Electrotechnical Association, *IEC 60601-2-4, Medical Electrical Equipment – Part 2-4: Particular Requirements for the Basic Safety and Essential Performance of Cardiac Defibrillators: 2010*.

SpO₂ Specifications and Validation

This appendix describes clinical validation data for SpO₂, SpCO, and SpMet monitoring.

SpO2 Specifications and Validation

The following accuracy information is provided by sensor family type and reflects the sensor family accuracy distribution. The data is comprised of healthy male and female volunteers with light to dark skin pigmentation in induced hypoxia studies in the range of 70-100% SpO2 against a laboratory CO-Oximeter.

Reusable Sensors

The following chart applies to these sensors:

- Masimo® LNCS Reusable SpO₂ Sensor, Adult
- Masimo LNCS Reusable SpO₂ Sensor, Pediatric
- Masimo Red Reusable Direct Connect SpO₂ Sensor, Adult 3 ft
- Masimo Red Reusable Direct Connect SpO₂ Sensor, Adult 12 ft
- Masimo Rainbow Direct Connect Reusable Sensor, Pediatric 3 ft (SpO₂, SpCO, SpMet)
- Masimo Rainbow Direct Connect Reusable Sensor, Pediatric 12 ft (SpO₂, SpCO, SpMet)
- Masimo Rainbow Direct Connect Reusable Sensor, Adult 3 ft (SpO₂, SpCO, SpMet)
- Masimo Rainbow Direct Connect Reusable Sensor, Adult 12 ft (SpO₂, SpCO, SpMet)
- Masimo Red Reusable Direct Connect SpO₂ Sensor, Pediatric 3 ft
- Masimo Red Reusable Direct Connect SpO₂ Sensor, Pediatric 12 ft
- Masimo Rainbow Direct Connect Reusable Sensor, Adult 8 ft (SpO₂, SpCO, SpMet)
- Masimo M-LNCS Reusable Adult SpO₂ Sensor
- Masimo M-LNCS Reusable Pediatric SpO₂ Sensor
- Masimo Rainbow Direct Connect Reusable Sensor, Pediatric 8 ft (SpO₂, SpCO, SpMet)
- Masimo Rainbow DCI Reusable Sensor, Adult (SpO₂, SpCO, SpMet)
- Masimo Rainbow DCIP Reusable Sensor, Pediatric
- Rainbow DCI-6 Adt Reuse Sensor, 6 ft, 3657, RoHS
- Rainbow DCIP-6 Ped Reuse Sensor, 6 ft, 3658, RoHS

SpO₂ Specifications and Validation

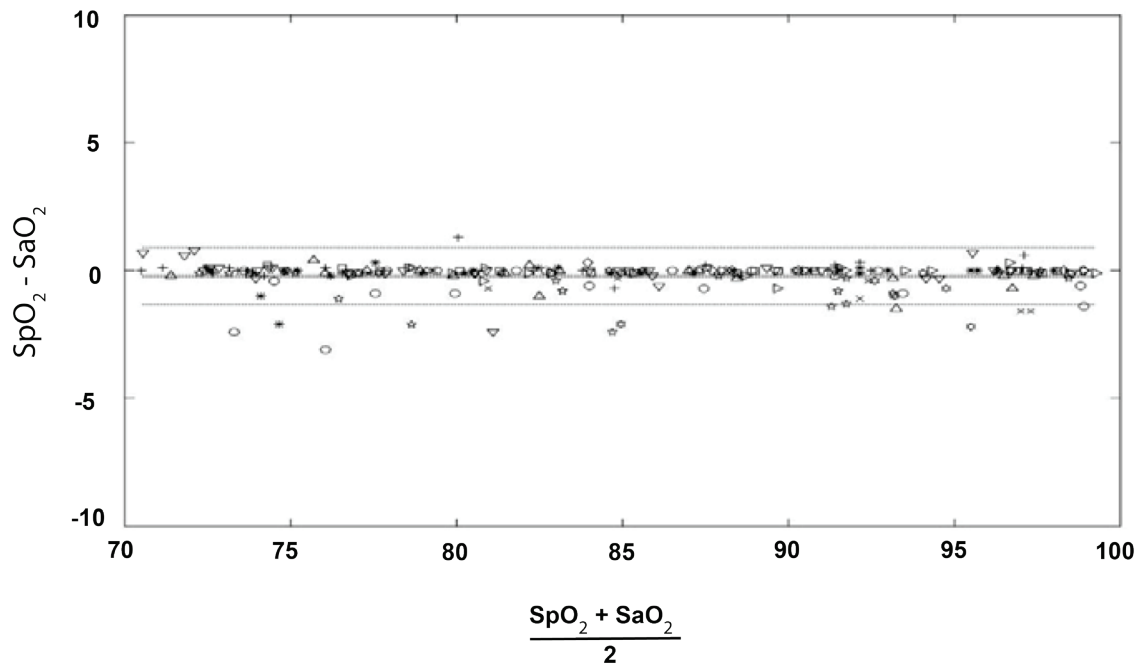

MEASURED ARMS VALUES	
SpO ₂ Range	Arms
90-100%	0.60%
80-90%	0.54%
70-80%	0.67%

The following chart applies to these sensors:

- Masimo M-LNCS DBI, Soft Sensor, REF 2507, RoHS
- Masimo DigitBoot Red DBI-Adult Soft Reusable Direct Connect SpO₂ Sensor, 8 ft (Ref 2644)
- Masimo DigitBoot LNCS, Adult Resuseable SpO₂ Sensor, 3 ft (Ref 2653)

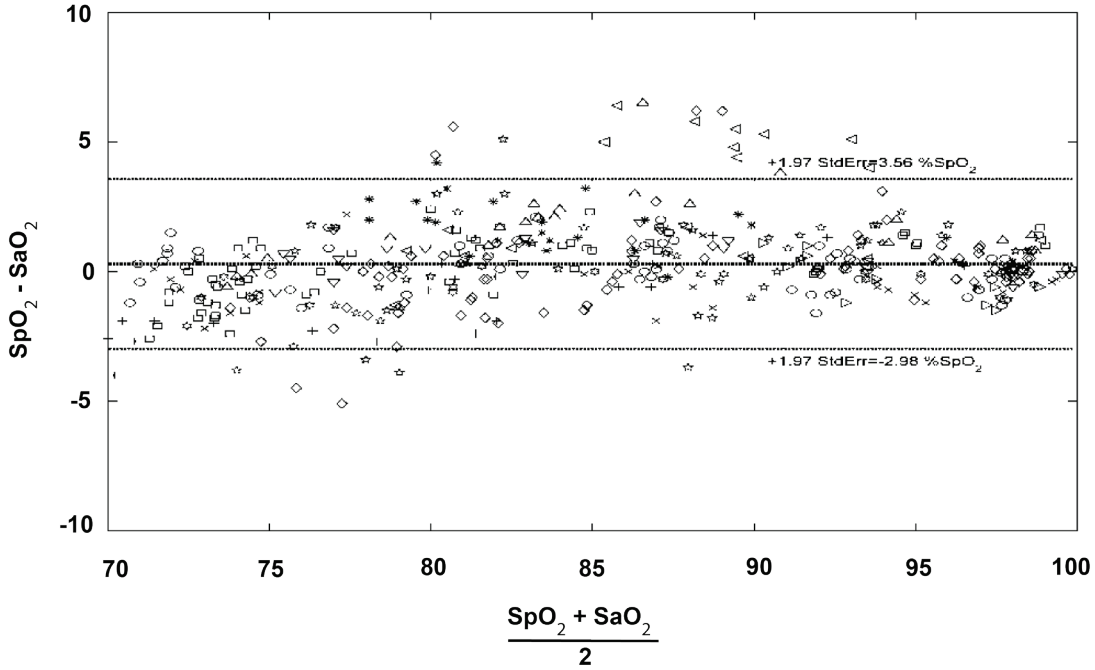

MEASURED ARMS VALUES	
SpO ₂ Range	Arms
90-100%	1.03%
80-90%	2.03%
70-80%	1.03%

The following chart applies to this sensor:

- Nellcor™ DURASENSOR Reusable Clip, Adult Fingertip Sensor, DS100A

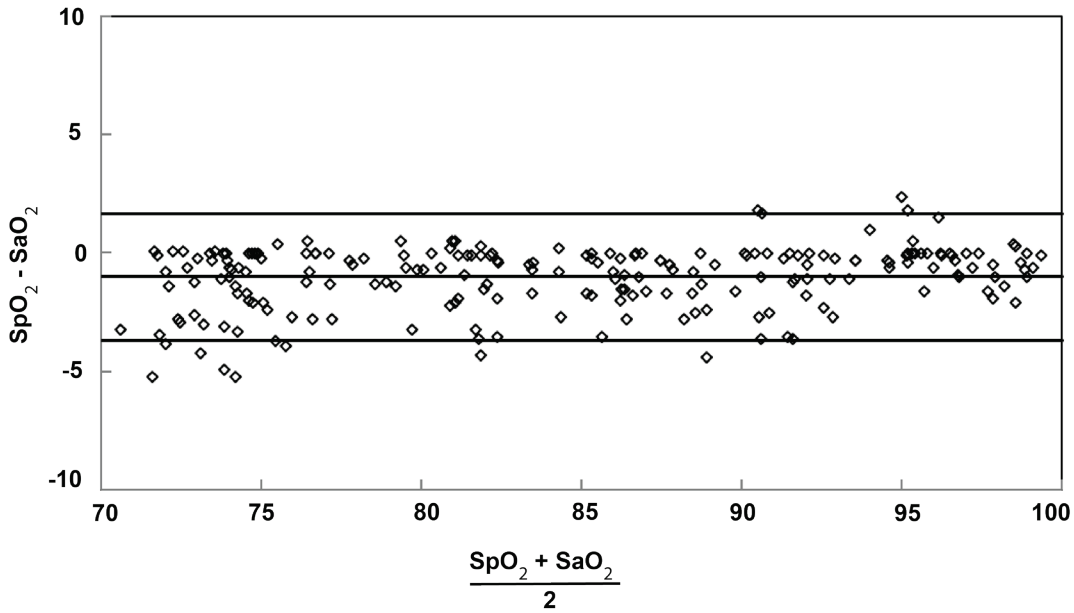

MEASURED ARMS VALUES	
SpO ₂	Arms
90-100%	1.38%
80-90%	1.56%
70-80%	2.01%

Disposable Sensors

The following chart applies to these sensors:

- Masimo LNCS Disposable Adhesive Sensor, Adult (20/box)
- Masimo LNCS Disposable Pediatric SpO₂ Sensor (20/Box)
- Masimo M-LNCS Disposable Adult Adhesive SpO₂ Sensor (20/Box)
- Masimo M-LNCS Disposable Pediatric Adhesive SpO₂ Sensor (20/Box)
- Masimo M-LNCS Disposable Adhesive SpO₂ Sensor, Sample Pack

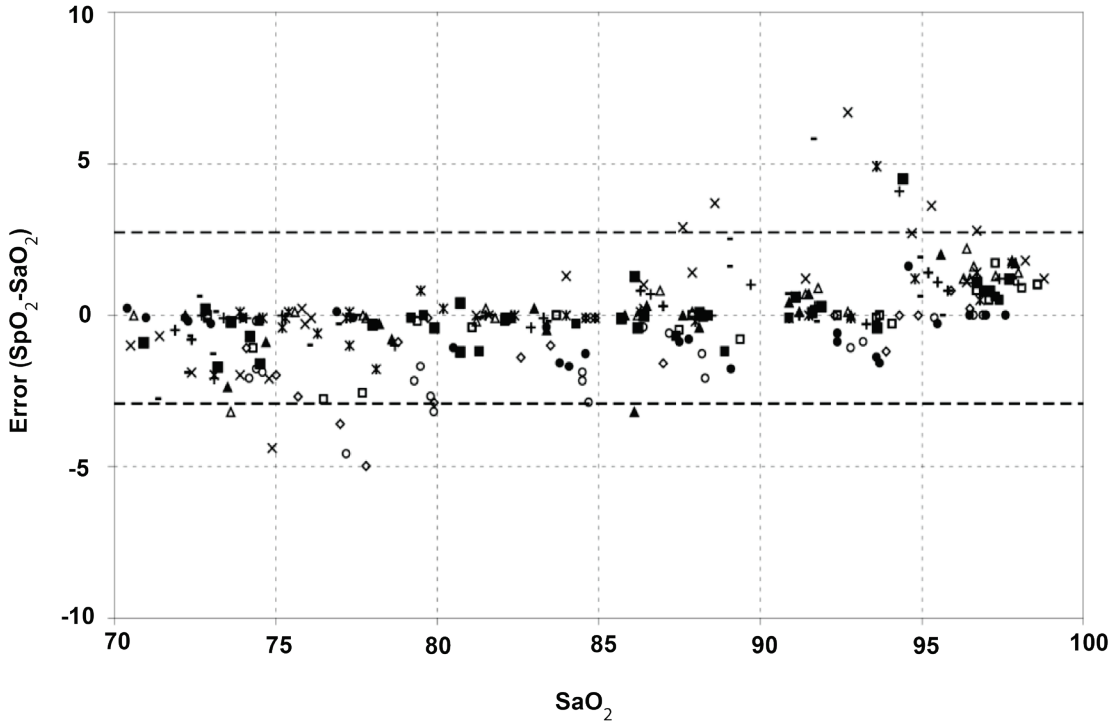

MEASURED ARMS VALUES	
SpO ₂ Range	Arms
90-100%	1.64%
80-90%	1.07%
70-80%	1.55%

The following chart applies to these sensors:

- Masimo LNCS Disposable Infant SpO₂ Sensor (20/Box)
- Masimo LNCS Disposable Neonatal SpO₂ Sensor (20/Box)
- Masimo LNCS Disposable Neonatal PT-L SpO₂ Sensor (20/Box)
- Masimo M-LNCS Disposable Infant Adhesive SpO₂ Sensor (20/Box)
- Masimo M-LNCS Disposable Neonatal/Adult Adhesive SpO₂ Sensor (20/Box)
- Masimo M-LNCS Disposable Neonate/Pre-Term Adhesive SpO₂ Sensor (20/Box)
- Masimo M-LNCS Neonate Pre-Term 500 Non-Adhesive SpO₂ Sensor (20/Box)
- Masimo M-LNCS Disposable Adhesive SpO₂ Sensor, Sample Pack

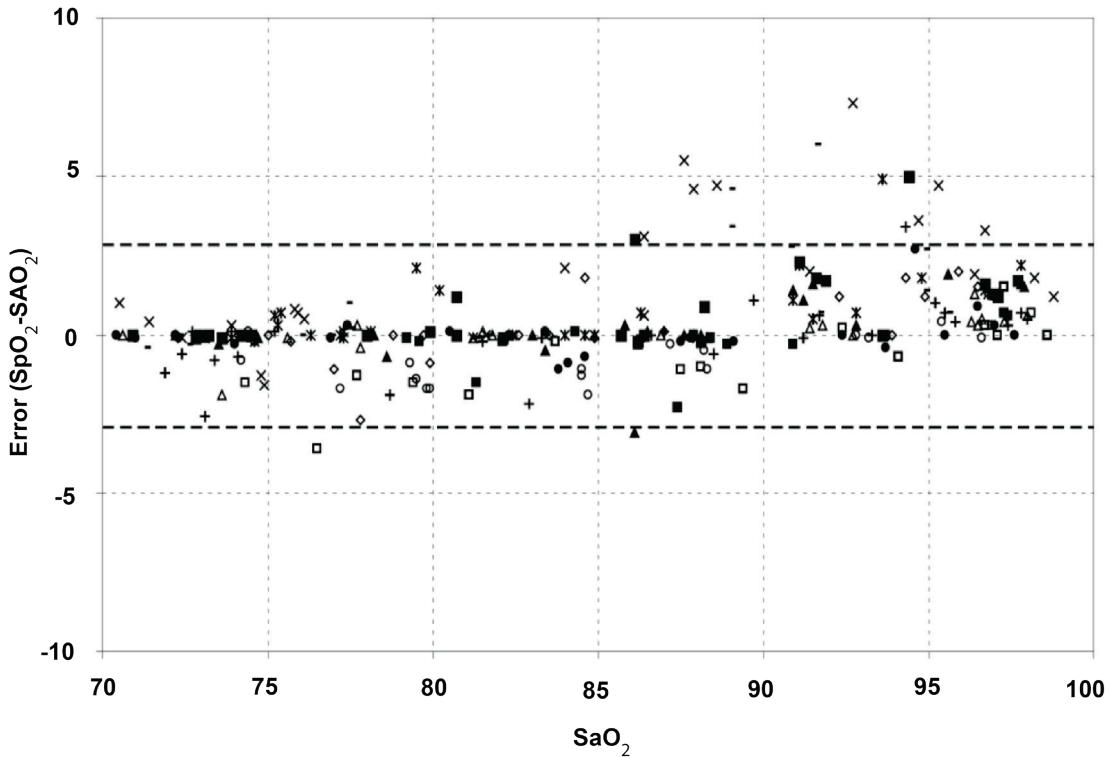

MEASURED ARMS VALUES	
SpO ₂ Range	Arms
90-100%	1.85%
80-90%	1.44%
70-80%	0.89%

The following chart applies to these sensors:

- LNCS E1, Adult, ear Sensor, REF 2918, RoHS
- M-LNCS E1, Adult, ear Sensor, REF 2919, RoHS

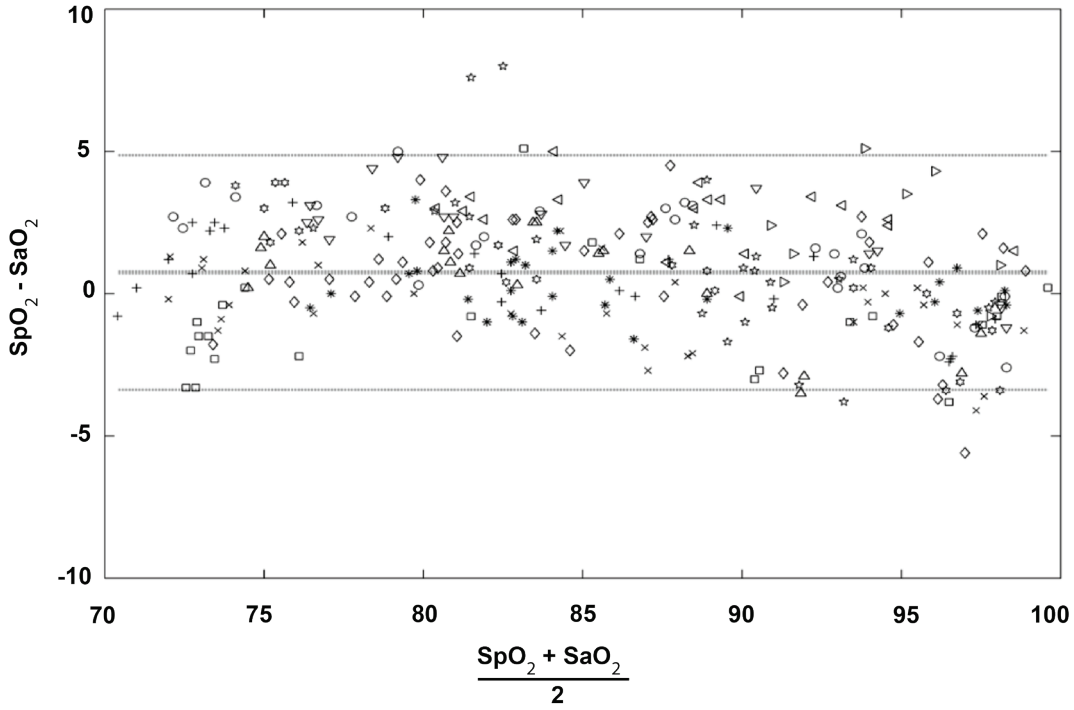

MEASURED ARMS VALUES	
SpO ₂ Range	Arms
90-100%	2.04%
80-90%	2.06%
70-80%	2.52%

The following chart applies to these sensors:

- Masimo Rainbow Disposable Adhesive Sensor, Neo/Adult (10/Box) (SpO₂, SpCO, SpMet)
- Masimo Rainbow Disposable Adhesive Sensor, Infant (10/Box) (SpO₂, SpCO, SpMet)
- Masimo Rainbow Disposable Adhesive Sensor, Adult (10/Box) (SpO₂, SpCO, SpMet)
- Masimo Rainbow Disposable Adhesive Sensor, Pediatric (10/Box) (SpO₂, SpCO, SpMet)

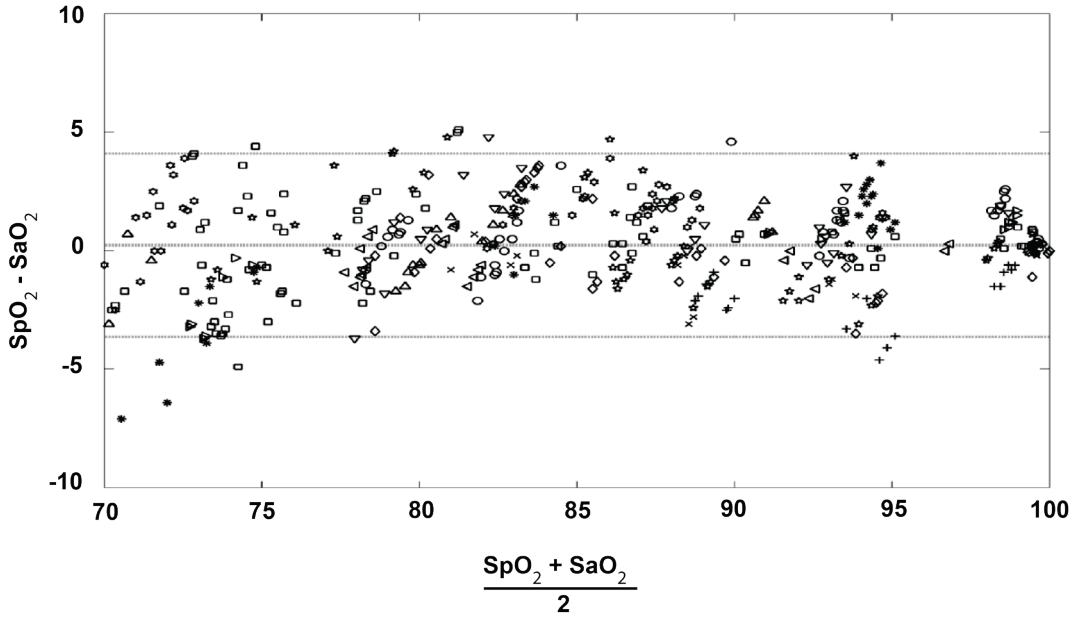

MEASURED ARMS VALUES	
SpO ₂ Range	Arms
90-100%	1.57%
80-90%	1.80%
70-80%	2.47%

Masimo Clinical Validation Data

Masimo Corporation conducted clinical studies and tests to assess the accuracy of the SpO₂, SpCO, and SpMet measurement functions. The following paragraphs provide a summary of that data.

Test Methods for Accuracy

SpO₂, SpCO and SpMet accuracy was determined by testing on healthy adult volunteers in the range of 60-100% SpO₂, 0-40% SpCO, and 0-15% SpMet against a laboratory CO-oximeter. SpO₂ and SpMet accuracy was determined on 16 neonatal intensive care patients ranging in age from 7-135 days old and weighing between 0.5-4.25 kg. Seventy-nine (79) data samples were collected over a range of 70-100% SaO₂ and 0.5-2.5% MetHb with a resultant accuracy of 2.9% SpO₂ and 0.9% SpMet.

The Masimo sensors have been validated for no motion accuracy in human blood studies on healthy adult male and female volunteers with light to dark skin pigmentation in induced hypoxia studies in the range of 70-100% SpO₂ against a laboratory CO-oximeter and ECG monitor. This variation equals plus or minus one standard deviation. Plus or minus one standard deviation encompasses 68% of the population weight.

The Masimo sensors have been validated for motion accuracy in human blood studies on healthy adult male and female volunteers with light to dark skin pigmentation in induced hypoxia studies while performing rubbing and tapping motions at 2 to 4 Hz at an amplitude of 1 to 2 cm, and a non-repetitive motion between 1 to 5 Hz at an amplitude of 2 to 3 cm in induced hypoxia studies in the range of 70-100% SpO₂ against a laboratory CO-oximeter and ECG monitor. This variation equals plus or minus one standard deviation which encompasses 68% of the population.

The Masimo sensors have been validated for pulse rate accuracy for the range of 25-240 bpm in bench top testing against a Biotek Index 2 simulator. This variation equals plus or minus one standard deviation which encompasses 68% of the population.

Nellcor Clinical Validation Data

Nellcor conducted clinical studies and tests to assess the accuracy of the SpO₂ measurement function of the Nellcor SpO₂ sensors. The following paragraphs provide a summary of that data.

Test Methods for Accuracy

SpO₂ accuracy specifications for Nellcor sensors are based on controlled hypoxia studies with healthy nonsmoking adult volunteers over the specified saturation SpO₂ range. Pulse oximeter SpO₂ readings were compared to SaO₂ values of drawn blood samples measured by hemoximetry.

Subjects used to validate SpO₂ measurement accuracies were healthy and recruited from the local population. The study group comprised both men and women; subjects spanned a range of skin pigmentations and ranged in age from 18-50 years old. When sensors are used on neonatal subjects as recommended, the specified accuracy is decreased by $\pm 1\%$, as compared to adult usage, to account for the theoretical effect on oximeter measurements of fetal hemoglobin in neonatal blood.

Electromagnetic Compatibility Guidance

This appendix provides guidance and manufacturer's declaration of electromagnetic compatibility.

Electromagnetic Compatibility Guidance

Electromagnetic Emissions

Table 50 Guidance and Manufacturer’s Declaration - Electromagnetic Emissions

<p>The LIFEPAK 15 monitor/defibrillator is intended for use in the electromagnetic environment specified below. The customer or the user of the LIFEPAK 15 monitor/defibrillator should assure that it is used in such an environment.</p>		
Emissions Test	Compliance	Electromagnetic Environment - Guidance
RF emissions CISPR 11	Group 1	The LIFEPAK 15 monitor/defibrillator uses RF energy only for its internal function. Therefore, its RF emissions are very low and are not likely to cause any interference in nearby electronic equipment.
RF emissions CISPR 11	Class B	The LIFEPAK 15 monitor/defibrillator is suitable for use in all establishments, including domestic establishments and those directly connected to the public low-voltage power supply network that supplies buildings used for domestic purposes.
Harmonic emissions IEC 61000-3-2	Class A	
Voltage fluctuations/ flicker emissions IEC 61000-3-3	4%	

Electromagnetic Immunity

Table 51 Guidance and Manufacturer’s Declaration - Electromagnetic Immunity

<p>The LIFEPAK 15 monitor/defibrillator is intended for use in the electromagnetic environment specified below. The customer or the user of the LIFEPAK 15 monitor/defibrillator should assure that it is used in such an environment.</p>			
Immunity Test	IEC 60601 Test Level	Compliance Level	Electromagnetic Environment - Guidance
Electrostatic discharge (ESD) IEC 61000-4-2	±8 kV contact ±2 kV, ±4 kV, ±8 kV, ±15 kV air	±8 kV contact ±2 kV, ±4 kV, ±8 kV, ±15 kV air	Floors should be wood, concrete, or ceramic tile. If floors are covered with synthetic material, the relative humidity should be at least 30%.
Electrical fast transient/burst IEC 61000-4-4	±2 kV for power supply lines ±1 kV for input/output lines	±2 kV for power supply lines ±1 kV for input/output lines	Mains power quality should be that of a typical commercial or hospital environment.
Surge IEC 61000-4-5	±1 kV line(s) to line(s) ±2 kV line(s) to earth	±1 kV line(s) to line(s) ±2 kV line(s) to earth	Mains power quality should be that of a typical commercial or hospital environment.
Voltage dips, short interruptions and voltage variations on power supply input lines IEC 61000-4-11	0% U_T during 1/2 cycles at 0°, 45°, 90°, 135°, 180°, 225°, 270°, and 315° 70% U_T during 25/30 cycles Single phase at 0°	0% U_T during 1/2 cycles at 0°, 45°, 90°, 135°, 180°, 225°, 270°, and 315° 70% U_T during 25/30 cycles Single phase at 0°	Mains power quality should be that of a typical commercial or hospital environment. If the user of the LIFEPAK 15 monitor/defibrillator requires continued operation during power mains interruptions, it is recommended that the LIFEPAK 15 monitor/defibrillator be powered from an uninterruptible power supply or a battery.
Power frequency (50/60 Hz) magnetic field IEC 61000-4-8	Level 4: 30 A/m	Level 4: 30 A/m	Power frequency magnetic fields should be at levels characteristic of a typical location in a typical commercial or hospital environment.
<p>Note: U_T is the AC Mains voltage prior to application of the test level.</p>			

Table 52 Guidance and Manufacturer’s Declaration - Electromagnetic Immunity

The LIFEPAK 15 monitor/defibrillator is intended for use in the electromagnetic environment specified below. The customer or the user of the LIFEPAK 15 monitor/defibrillator should assure that it is used in such an environment.

Immunity Test	IEC 60601 Test Level	Compliance Level
Conducted RF IEC 61000-4-6	3 Vrms 150 kHz to 80 MHz outside ISM bands ¹	3 Vrms
	6 Vrms 150 kHz to 80 MHz in ISM and amateur bands ¹	10 Vrms ISM 6 Vrms amateur
Radiated RF IEC 61000-4-3	10 V/m ² 80 MHz to 2.7 GHz	10 V/m

¹ The ISM (industrial, scientific and medical) bands between 150 kHz and 80 MHz are 6.765 MHz to 6.795 MHz; 13.553 MHz to 13.567 MHz; 26.957 MHz to 27.283 MHz; and 40.66 MHz to 40.70 MHz. The amateur radio bands between 150 kHz and 80 MHz are 1.8 MHz to 2.0 MHz, 3.5 MHz to 4.0 MHz, 5.3 MHz to 5.4 MHz, 7.0 MHz to 7.3 MHz, 10.1 MHz to 10.15 MHz, 14.0 MHz to 14.2 MHz, 18.07 MHz to 18.17 MHz, 21.0 MHz to 21.4 MHz, 24.89 MHz to 24.99 MHz, 28.0 MHz to 29.7 MHz, and 50.0 MHz to 54.0 MHz.

² The following parameters were subjected to these Radiated Immunity levels and meet their essential performance per their Radiated Immunity levels defined in the particular standards: IP (IEC 60601-2-34:2011), CO₂ (ISO 80601-2-55:2011).

Separation Distances

Table 53 Recommended Separation Distances Between Portable and Mobile RF Communications Equipment and the LIFEPAK 15 Monitor/Defibrillator

The LIFEPAK 15 monitor/defibrillator is intended for use in an electromagnetic environment in which radiated RF disturbances are controlled. The customer or the user of the LIFEPAK 15 monitor/defibrillator can help prevent electromagnetic interference by maintaining a minimum distance between portable and mobile RF communications equipment (transmitters) and the LIFEPAK 15 monitor/defibrillator as recommended below, according to the maximum output power of the communications equipment.

The LIFEPAK 15 monitor/defibrillator was tested to various RF wireless communication environments to meet a minimum separation distance as recommended by IEC 60601-1-2:2014. The following table describes the environments and the equation for calculating the recommended separation distance at the maximum power level for each band.

Band (MHz)	Service	Maximum Power (W)	Distance (m)	Equation
380-410	TETRA 400 T-GSM-380 T-GSM-410	1.8	0.3	$d = 6/27 \sqrt{P}$
430-470	GMRS 460 FRS 460 LTE Band 31 4G/LTE-A	2.0	0.3	$d = 6/28 \sqrt{P}$
470-500	GSM-480	1.8	0.3	$d = 6/27 \sqrt{P}$
704-787	LTE Band 12, 13, 17, 20, 26 GSM-710 GSM-750	0.2	0.3	$d = 6/9 \sqrt{P}$
800-960	GSM 800/900 TETRA 800 iDEN 820 CDMA 850 LTE Band 5, 8, 27 PRS-900 T-GSM-810 GSM-580 P-GSM-900 E-GSM-900/UTRA R-GSM-900 T-GSM-900 UTRA Band 5	2.0	0.3	$d = 6/28 \sqrt{P}$
1480-1530	UTRA Band 11/LPDC (Japan)	2.0	0.3	$d = 6/28 \sqrt{P}$

Band (MHz)	Service	Maximum Power (W)	Distance (m)	Equation
1700-2100	GSM 1800 CDMA 1900 GSM 1900 DECT LTE Band 1, 3, 4, 25 UMTS DCS-1800 PCS-1900 UTRA Band 1, 2, 4, 9	2.0	0.3	$d = 6/28 \sqrt{P}$
2400-2570	Bluetooth WLAN 802.11 b/g/n RFID 2450 LTE Band 7	2.0	0.3	$d = 6/28 \sqrt{P}$
5100-5800	WLAN 802.11 a/n 4G/LTE-A	0.2	0.3	$d = 6/9 \sqrt{P}$

For transmitters in the frequency ranges listed above, the recommended separation distance *d* in meters (m) can be determined using the equation in the table above with the known power, *P* of the transmitter in watts (W) according to the transmitter manufacturer.

Note: These guidelines may not apply in all situations. Electromagnetic propagation is affected by absorption and reflection from structures, objects and people.

Wireless Specifications

Table 54 Wireless Specifications

The LIFEPAK 15 monitor/defibrillator meets the following specification for wireless transmission and reception, in accordance with IEC 60601-1-2.

Protocol	Center Frequency (MHz)	Modulation Type	Effective Radiated Power (mW)	Effective Radiated Power (dBm)
Bluetooth	2400.0-2483.5	GFSK, n/4 DQPSK, 8 DPSK	6	7.8

Radio Equipment Directive

Hereby, Physio-Control declares that the radio equipment type LIFEPAK 15 Defibrillator is in compliance with Directive 2014/53/EU. The full text of the EU declaration of conformity is available at the following internet address: www.physio-control.com/EUDoC.



Symbols

This appendix provides information about the symbols that are used in these operating instructions, or on the LIFEPAK 15 monitor/defibrillator, its accessories, packaging, or training tools.





















Symbols





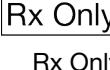









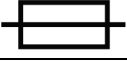

The symbols in the following table may be found in these operating instructions or on the LIFEPAK 15 monitor/defibrillator, its accessories, packaging, or training tools.

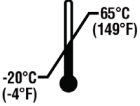
Table 55 Symbols

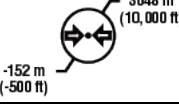
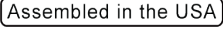

















SYMBOL	DESCRIPTION
Device or User Interface	
	Operating instructions
	Follow instructions for use
	General warning
	Caution
	Alarm on
	Alarm off
	VF/VT alarm on
	VF/VT alarm is on, but is silenced or suspended
	Battery in well, fully charged. For a description of all battery indicators, see Battery Status Indicators (on page 40).
	Heart rate/pulse rate indicator
	<i>Bluetooth</i> wireless technology
	Shock count (x) on screen
	Shock button on front panel or hard paddles
	Auxiliary power indicator
	Battery charging indicator
	Service indicator
	Greater than
	Less than







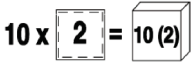
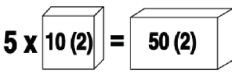









Symbols

SYMBOL	DESCRIPTION
J	Joules
	Display mode button
	Home Screen button
	CO ₂ input
 CO ₂	CO ₂ exhaust
	Input/output
	Defibrillation-proof type CF applied part
	Defibrillation-proof type BF applied part
	Do not dispose of this product in the unsorted municipal waste stream. Dispose of this product according to local regulations. See www.physio-control.com/recycling for instructions on disposing of this product.
	Symbol for China RoHS indicating the Environmentally Friendly Use Period (EFUP) denoting the number of years before any substance is likely to leak out into the environment.
	Mark of conformity to applicable European Directives
	Canadian Standards Association certification for Canada and the United States
	Intertek certification for Canada and the United States
IP44	Protected against particles >1.0 mm and splashing water
	Date of manufacture shown: YYYY-MM-DD
	Authorized EC representative
	Part number
	Serial number
	Catalog number
 or Rx Only	By prescription only
	For USA audiences only
	See website for patent information
	See website for patent information















SYMBOL	DESCRIPTION
	Manufacturer
	Indicates that a product complies with applicable Australian ACMA standards
	Positive terminal
	Negative terminal
	Fuse
	Battery
	Power input
	Static-sensitive device. Static discharge may cause damage.
	Device has V4 components
	Recommended storage temperature range -20° to 65°C (-4° to 149°F)
	Recommended storage humidity range 10 to 95%
	Recommended storage atmospheric pressure range -152 to 3048 m (-500 to 10,000 ft.)
	Assembled in the USA
Reports	
	Biphasic defibrillation shock
	Pace arrow, noninvasive pacing
	Pace arrow, internal pacing detection
	QRS sense marker
	Event marker

Symbols

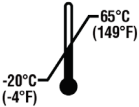
SYMBOL	DESCRIPTION
Accessories	
	Mark of conformity to applicable European Directives
	Underwriters Laboratories recognized component mark for the United States
	Underwriters Laboratories recognized component mark for Canada and the United States
	Complies with (USA) Federal Communications Commission regulations
	Type BF applied part
	Lot number (batch code)
IP44	Protected against particles >1.0 mm and splashing water
	Warning, high voltage
	Caution
	CAUTION - FIRE HAZARD Do not disassemble, heat above 100°C (212°F), or incinerate battery
	CAUTION - FIRE HAZARD Do not crush, puncture, or disassemble battery
	Use By date shown: YYYY-MM-DD
	Indoor use only
	Not made with natural rubber latex
	Lead free
	Do not reuse
	2 electrodes in 1 package
	10 packages in 1 shelf-pak
	5 shelf-paks in 1 case
	Shave patient skin
	Clean patient skin

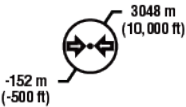
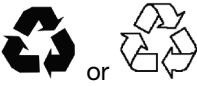
SYMBOL	DESCRIPTION
	Treatment
	Tear here
	Press electrode firmly onto patient
	Connect QUIK-COMBO cable
	Slowly peel back protective liner on electrode
	Do not use this pediatric QUIK-COMBO electrode on LIFEPAK 500, LIFEPAK 1000, LIFEPAK CR [®] Plus, or LIFEPAK EXPRESS [®] defibrillators
	For use on adults
	Not for use on adults
	For use on children up to 15 kg (33 lb)
	Not for use on children under 15 kg (33 lb)
	Remove label from battery
	Charge battery
	Insert battery in LIFEPAK 15 monitor/defibrillator
	Rechargeable battery
	AC-DC power adapter
	DC-DC power adapter
	For use with the LIFEPAK 15 monitor/defibrillator

Symbols

SYMBOL	DESCRIPTION
	Battery for use with the LIFEPAK 15 monitor/defibrillator
	Power input
	Power output
	Direct current voltage
	Alternating current voltage
	Do not dispose of this product in the unsorted municipal waste stream. Dispose of this product according to local regulations. See www.physio-control.com/recycling for instructions on disposing of this product.
Shipping carton	
	This end up
	Fragile. Handle with care.
	Keep dry
	Recommended storage temperature range -20° to 65°C (-4° to 149°F)
	Recommended storage humidity range 10 to 95%
	Recommended storage atmospheric pressure range -152 to 3048 m (-500 to 10,000 ft.)
	Recycle this item
	Quantity
	Refurbished device
	Used device

Index

1

- 12-Lead ECG Procedure • 63
- 12-Lead ECG Warning • 61

3

- 3-Channel Format • 66

4

- 4-Channel Format • 67

A

- A. Acquisition and Annotation Methodology • 278
- About Transmitting Patient Records and Reports • 181
- AC Power Adapter operation • 199
- Accessing Archive Mode • 175
- Accessories • 226
- Accessories for the LIFEPAK 15 Monitor/Defibrillator • 226
- Acquiring a 12-Lead ECG • 61
- Activating and Deactivating the Metronome • 142
- Adjusting the Systole Volume • 52
- Adult Standard Paddles • 160
- Advisory monitoring • 133
- AED mode • 124
- AED Procedure • 124
- AED Warnings • 123
- Age-Airway Considerations • 141
- Alarm Performance Characteristics • 248
- Alarms • 41
- Analysis Event • 171
- Anterior-Lateral Placement • 52, 121
- Anterior-Posterior Placement • 122
- Applicable Products • 4
- Area 1 • 24
- Area 1 Controls • 25
- Area 2 • 26
- Area 2 Controls • 26
- Area 3 • 27

- Area 3 Controls • 27
- Area 4 • 28
- Area 4 Controls • 28
- Area 5 • 29
- Area 5 Connectors, Speaker, and Printer • 29
- Attaching Pediatric Paddles • 162
- Auto Tests • 208
- Automated External Defibrillation (AED) • 123
- Automated Interpretation of the ECG • 277
- Averaging time • 79

B

- B. ECG Rhythm Types • 279
- Back View • 33, 34
- Background • 263, 272
- Basic Orientation • 21, 197
- Batteries • 35
- Battery Maintenance • 215
- Battery Specifications • 244
- Battery Status Indicators • 40
- Battery Warnings • 215
- Blood Pressure Alarm Limits • 245
- Bluetooth Passcodes • 183
- Bluetooth search filter • 183
- Bluetooth Setup • 184
- Bluetooth Status • 186

C

- C. Summary Shock Advisory System Performance Report • 280
- Cancelling a Transmission • 191
- Capnography Alarm Limits • 246
- Changing ECG Size • 51
- Changing the Initial Inflation Pressure • 86
- Charging Batteries • 217
- Check Patient Event • 172
- Cleaning • 79, 89, 96, 202
- Cleaning and Disposal • 110
- Cleaning and Inspecting Pediatric Paddles • 164
- Cleaning and Inspecting Standard Paddles • 161
- Cleaning and Inspection • 103, 159
- Cleaning the Device • 218
- Clinical Summary
 - Monophasic vs. Biphasic Waveforms
 - Out-of-Hospital Trial • 272
- CO2 alarms • 95
- CO2 detection • 96

- CO2 Display • 95
- CODE SUMMARY Formats • 168
- CODE SUMMARY Report • 168
- Color Coding for ECG Leads • 56
- Computerized ECG analysis • 65
- Conclusion • 273
- Conclusions • 264, 268, 270
- Connecting and Disconnecting the Therapy Cable • 31
- Connecting Therapy Electrodes • 158
- Connectors • 30
- Considerations When Transmitting Data • 191
- Continuous Patient Surveillance System • 281
- Contraindications • 61, 71, 83, 91, 99, 107, 123, 137, 148
- CPR Metronome Warnings • 141
- CPR Time and Metronome • 130
- Cuff selection • 86

D

- Data Management • 165
- Data transmission • 179
- DC Power Adapter Operation • 200
- Default Age-Airway C
 V Ratios in Manual Mode • 141
- Defibrillation Clinical Summaries • 261
- Defibrillation of Ventricular Fibrillation and Ventricular Tachycardia • 263
- Definitions and References • 282
- Deleting Archived Patient Records • 178
- Demand and Nondemand Pacing • 149
- Displaying and Printing Trend Graphs • 115
- Disposable Sensors • 289

E

- ECG Leads Color Codes • 56
- ECG monitoring procedure • 55
- ECG Monitoring Warning • 49
- ECG Override • 64
- Editing Archived Patient Records • 177
- Electrode Contact Determination • 277
- Electrodes or Therapy Cable Off • 129
- Electromagnetic Compatibility Guidance • 295, 297
- Electromagnetic Emissions • 297
- Electromagnetic Immunity • 298
- Entering patient data • 44
- Establishing a Bluetooth Connection • 185
- EtCO2 Monitoring Procedure • 94

- EtCO2 Monitoring Warnings • 91
- EtCO2 Monitoring Waveform Analysis • 93
- Event/Vital Sign Log • 169
- Events • 45
- External Cardioversion of Atrial Fibrillation • 265

F

- Front View • 23
- Function checks • 210

G

- General Dangers and Warnings • 17
- General Maintenance • 202
- General Maintenance and Testing • 207
- General Therapy Warnings and Cautions • 119
- General troubleshooting tips • 220
- Guidance and Manufacturer's Declaration - Electromagnetic Emissions • 297
- Guidance and Manufacturer's Declaration - Electromagnetic Immunity • 298, 299
- Guidance for Selection of Shock Energy • 268, 271

H

- Heart Rate Alarm Limits • 244
- Home Screen • 37, 38
- How a Pulse Oximeter Works • 74
- How Capnography Works • 92
- How IP Monitoring Works • 101
- How NIBP Monitoring Works • 85
- How ST Trends Work • 113
- How Temperature Monitoring Works • 108
- How the CPR Metronome Works • 141
- How to Print a Current Report • 173
- How to Transmit a Current Patient Report • 189
- How to Transmit an Archived Patient Report • 189
- How VS Trends Work • 112

I

- Identifying Electrode Sites • 62
- Important Information • 4

- Indications • 61, 71, 83, 91, 99, 107, 123, 137, 148
- Initial CPR - Analyze First • 132
- Initial CPR - CPR First • 131
- Intended use • 13, 49, 61, 71, 83, 91, 99, 107, 111, 123, 137, 148
- Interpreting the ST Trend Graph • 114
- Intra-Operative Ventricular Defibrillation • 269
- Introduction • 13
- Invasive Pressure Alarm Limits • 246
- IP Labels and Descriptions • 100
- IP Monitoring • 100
- IP Monitoring Procedure • 102
- IP Monitoring Warnings • 99
- IP Scale Options • 103

L

- Leads Off • 56
- LIFEPAK 15 Monitor/Defibrillator Operator's Checklist • 317
- LIFEPAK 15 Monitor/Defibrillator Specifications • 231
- Limb Lead Electrode Sites • 62
- Loading paper • 219

M

- Maintaining the Equipment • 205
- Maintenance and service • 202
- Maintenance and Testing Schedule • 207
- Managing alarms • 42
- Managing Archived Patient Records • 175
- Managing Current Patient Records • 173
- Manual Defibrillation • 137
- Manual Defibrillation Procedure • 140
- Manual Defibrillation Warnings • 138
- Manual mode • 139
- Manual Single-Measurement Procedure • 87
- Masimo Clinical Validation Data • 293
- Memory capacity • 173
- Methods • 263, 272
- Modes of operation • 14
- Monitoring • 47
- Monitoring Continuous Temperature • 107
- Monitoring ETCO₂ • 91
- Monitoring Invasive Pressure • 99
- Monitoring Noninvasive Blood Pressure • 83
- Monitoring Patients Who Have Internal Pacemakers • 57
- Monitoring SpO₂, SpCO, and SpMet • 71

- Monitoring the ECG • 49
- Monitoring Using ECG Cable Accessories • 54
- Monitoring Using Paddle Accessories • 52
- Motion Detected • 129
- Motion detection • 282

N

- Navigating the Home Screen • 39
- Nellcor Clinical Validation Data • 294
- NIBP Monitoring Considerations • 85
- NIBP Monitoring Procedure • 86
- NIBP Monitoring Warnings and Caution • 83
- No Implied License • 73
- No Shock Advised • 128
- Noninvasive pacing • 148
- Noninvasive Pacing Procedure • 149
- Noninvasive Pacing Warnings • 148

O

- Obese Patients or Patients with Large Breasts • 122
- Objectives • 265, 269
- Operator Control of Shock Therapy • 281
- Options • 43
- Options Menu Selections • 43
- Output Extension Cable with Breakaway Connector • 201
- Overview • 265, 269, 277
- Oximeter Monitoring Procedure • 76

P

- Pacing Event • 172
- Packaging • 225
- Paddle Accessory Options • 155
- Paddles ECG Monitoring Procedure • 53
- Patient ECG Cable Check • 210
- Patient Records and Reports • 167
- Patient Skin Preparation • 121
- Patients with Implanted Devices • 123
- Pediatric ECG Monitoring and Manual Mode Therapy Procedures • 154
- Pediatric paddles • 161
- Performance Verification • 278
- Phases of the Waveform • 93
- Physio Service Class Prefixes • 184
- Physio-Control Test Set • 278
- Placing Pediatric Paddles • 162

- Pleth Waveform • 78
- Possible Event Log Entries • 170
- Power adapter • 195
- Preamble • 169
- Precordial Lead ECG Monitoring • 56
- Precordial lead electrode sites • 62
- Preface • 11
- Preparation • 225
- Preparing for a Wireless Transmission • 186
- Preparing the Monitor for Transmission • 182
- Pre-shock CPR Time • 133
- Printed 12-Lead ECG Frequency Response • 68
- Printed 12-Lead ECG Report Formats • 66
- Printing Archived Patient Reports • 176
- Product Recycling Information • 225
- Pulse Rate Monitoring • 79

Q

- QUIK-COMBO electrodes • 158
- QUIK-COMBO Therapy Electrodes • 157

R

- Radio Equipment Directive • 301
- Receiving New Batteries • 216
- Recommended Maintenance Schedule for Clinical Personnel • 208
- Recommended Separation Distances Between Portable and Mobile RF Communications Equipment and the LIFEPAK 15 Monitor/Defibrillator • 300
- Recycling Assistance • 225
- Recycling Batteries • 217
- Recycling of Disposable Electrodes • 225
- Re-establishing a Bluetooth Connection • 186
- Removing pediatric paddles • 162
- Replacing and Removing Therapy Electrodes • 158
- Replacing batteries • 217
- Report types • 167
- Results • 263, 265, 269, 272
- Reusable Sensors • 285

S

- Safety Information • 15
- SAS Test Set • 279
- Screen messages • 253

- Selecting ECG Lead • 50
- Self-Tests • 208
- Sensitivity • 78
- Sensor Application • 75
- Separation Distances • 300
- Service and repair • 224
- Service Life • 224
- Setting Alarms • 41
- Setup Options Factory Default Settings • 250
- Shock Advised • 126
- Shock Advisory System • 275
- Shock Counter • 129
- Shock Event • 172
- SpCO/SpMet Advisory • 77
- Special AED setup options • 131
- Special Situations for Electrode or Paddle Placement • 53, 122
- Specifications and Performance
 - Characteristics • 229, 231
- SpO2 Alarm Limits • 245
- SpO2 Specifications and Validation • 283, 285
- SpO2, SpCO, and SpMet Monitoring
 - Considerations • 74
- SpO2, SpCO, and SpMet Warnings and Cautions • 72
- Standard (Hard) Paddles Check • 210
- Standard Paddles • 160
- Standard Paddles Synchronized Cardioversion Check • 210
- Sterilizable internal defibrillation paddles • 164
- Storing batteries • 216
- Storing the Device • 218
- Summary of Screen Messages • 255
- Switching from AED Mode to Manual Mode • 130
- Symbols • 303, 305
- Synchronized cardioversion • 122
- Synchronized Cardioversion Procedure • 143

T

- TEMP Labels and Descriptions • 109
- Temperature Alarm Limits • 247
- Temperature Monitoring Equipment • 108
- Temperature Monitoring Procedure • 109
- Temperature Monitoring Warnings • 107
- Temperature Values and Messages • 108
- Terminating a Bluetooth Connection • 187
- Terms • 17
- Test Methods for Accuracy • 293, 294
- Testing Standard Paddles • 161
- Text Conventions • 4
- Therapy • 117

Therapy Cable Monitoring and Synchronized Cardioversion Check • 212
Therapy Cable Pacing Check • 213
Therapy Electrode and Standard Paddle Placement • 121
Thin Patients • 122
Timer-Controlled Measurement Procedure • 88
Transmission Status Report • 190
Transmitting Reports • 189
Troubleshooting tips • 58, 69, 80, 89, 97, 104, 110, 135, 145, 152, 192, 203
Troubleshooting Tips for AED Mode • 135
Troubleshooting Tips for Data Transmission • 192
Troubleshooting Tips for Defibrillation and Synchronized Cardioversion • 145
Troubleshooting Tips for ECG Monitoring • 58
Troubleshooting Tips for EtCO₂ Monitoring • 97
Troubleshooting Tips for IP Monitoring • 104
Troubleshooting Tips for NIBP Monitoring • 89
Troubleshooting Tips for Noninvasive Pacing • 152
Troubleshooting Tips for Power Adapter • 203
Troubleshooting Tips for SpO₂, SpCO, and SpMet • 80
Troubleshooting Tips for Temperature Monitoring • 110
Troubleshooting Tips for the 12-Lead ECG • 69

U

User Tests • 209
Using a Direct Connection • 187
Using Bluetooth Wireless Communication • 182
Using the CPR Metronome • 141
Using the Power Adapter • 199

V

Ventricular fibrillation • 263
Ventricular tachycardia • 264
Vital Sign and ST Segment Trends • 111
Volume • 78
VS and ST Monitoring Considerations • 115
VS and ST Trends Warning • 111

W

Warranty • 203, 225
Waveform events • 170
Wireless Specifications • 301

LIFEPAK 15 Monitor/Defibrillator Operator's Checklist



This is a recommended checklist to use to inspect and test this monitor/defibrillator. Daily inspection and test is recommended. This form may be reproduced.

Unit Serial No: _____ Location: _____

Instruction	Recommended Corrective Action	Date						
		Initials						

√ each box after completing

1. Inspect physical condition for:

Foreign substances	Clean the device.							
Damage or cracks	Contact a qualified service technician.							

2. Inspect power source for:

Broken, loose, or worn battery pins	Contact a qualified service technician.							
Damaged or leaking battery	Recycle or discard battery.							
Spare battery available	Obtain fully charged spare battery.							
Damage to power adapter and cables	Contact a qualified service technician.							

3. Inspect ECG cable and cable port for:

Cracking, damage, broken, or bent parts or pins	Replace ECG cable. If port is damaged, contact qualified service technician.							
---	---	--	--	--	--	--	--	--

4. Check ECG electrodes and therapy electrodes for:

Use By date	Replace if date passed.							
Spare electrodes available	Obtain spare electrodes.							
Damaged, opened package	Discard and replace electrodes.							

5. With batteries installed, disconnect from power adapter (if using), press ON and observe for:

Momentary illumination of self-test messages and LEDs, and speaker beep	If absent, contact a qualified service technician.							
Two fully charged batteries	Replace low battery or charge installed battery using power adapter.							
Service indicator ()	If illuminated, contact a qualified service technician.							

Instructions	Recommended Corrective Action	Date							
		Initials							

6. With batteries installed, reconnect power adapter to device and check for:

(If not using a power adapter, go to Step 7.)

Power adapter LED strip is illuminated If absent, check connections. If problem persists, contact a qualified service technician.

Auxiliary power LED on device is illuminated

Battery charging LED on device is illuminated or flashing If absent, check batteries. If problem persists, contact a qualified service technician.

7. Perform QUIK-COMBO® therapy cable check in Manual mode:*

(If this cable is not used with the defibrillator, go to Step 8)

- Disconnect and examine cable for cracking, damage, broken, or bent parts or pins. Replace QUIK-COMBO therapy cable.

- Connect therapy cable to defibrillator and the Test Load. If **CONNECT ELECTRODES, PADDLES LEADS OFF, CONNECT CABLE, or ABNORMAL ENERGY DELIVERY** message appears, replace therapy cable and repeat check. If problem continues, remove the defibrillator from use and contact a qualified service technician.
- Select **LEAD**, then **PADDLES**.
- Select **200 JOULES** and press **CHARGE**.
- Press ⚡ (shock) button.

- Confirm **ENERGY DELIVERED** message appears. If message does not appear, replace therapy cable and repeat check.

- Remove Test Load from cable and verify **PADDLES LEADS OFF** appears.** If absent, contact a qualified service technician.

8. Perform standard (hard) paddles check in Manual mode.*

(If hard paddles are not used with the defibrillator, go to Step 9.)

- Disconnect and examine cable for cracking, damage, broken, or bent parts or pins. Replace paddles.

- Connect paddles to defibrillator.

- Examine for paddle surface pitting and presence of dried or wet gel. Replace paddles, or clean paddles.

- Press **LEAD**. Select **PADDLES**.

- On paddles, turn **ENERGY SELECT** dial to **10 JOULES*****. If selected energy does not change or charging does not occur, obtain spare paddles and repeat check. If problem continues, remove the defibrillator from use and contact a qualified service technician.
- With paddles in paddle wells, press **CHARGE** button on paddle.

Instructions	Recommended Corrective Action	Date						
		Initials						

- Press only *one* ⚡ (shock) button and release. Confirm that energy was not discharged.
- Press the other ⚡ (shock) button and release. Confirm that energy was not discharged.
- Press both ⚡ (shock) buttons and confirm **ABNORMAL ENERGY DELIVERY** message appears.
- Remove paddles from wells, and confirm artifact on screen.
- Place paddle surfaces together, and confirm flat line on screen.
- Return paddles securely to paddle wells.

If energy discharges with one button press, obtain spare paddles and repeat check.

If message does not appear, obtain spare paddles and repeat check. If problem continues, remove the defibrillator from use and contact a qualified service technician.

If task fails, obtain spare paddles and repeat check. If problem continues, remove the defibrillator from use and contact a qualified service technician.

9. Perform User Test if 3:00 am auto test results not available:

- Press **OPTIONS**.
- Select **USER TEST** in menu.
- Confirm test results printed.

If User Test fails, remove the defibrillator from use and contact a qualified service technician.

--	--	--	--	--	--	--	--

10. Check ECG printer for:

- Adequate paper supply
- Ability to print

Add new paper, if necessary.

If not working, contact a qualified service technician.

11. If using wireless data transmission, test transmission method:

- Establish a Bluetooth connection.
- Send a test transmission.

If not working, contact a qualified service technician.

12. Turn off defibrillator.

(Press and hold **ON** for up to 2 seconds.)

13. Confirm that the device is stowed, mounted, or positioned securely.

--	--	--	--	--	--	--	--

* The defibrillator delivers up to 360 joules of electrical energy. Unless discharged properly, this electrical energy may cause serious personal injury or death. Do not attempt to perform this test unless you are qualified by training and experience.

** Failure to remove the Test Load may result in delay of therapy during patient use.

*** Discharging > 10 joules in the paddle wells may damage the defibrillator.

LIFEPAK[®] 15 MONITOR/DEFIBRILLATOR

Operating Instructions

Physio-Control is now part of Stryker.

For further information, please call Physio-Control at 1.800.442.1142 or visit www.physio-control.com

Physio-Control, Inc.

11811 Willows Road NE
P.O. Box 97006
Redmond, WA 98073-9706 USA
Tel 425.867.4000
Fax 425.867.4121
www.physio-control.com



Physio-Control, Inc.
11811 Willows Road NE, Redmond, WA 98052 USA

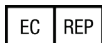

Stryker European Operations B.V.
Herikerbergweg 110, 1101 CM Amsterdam, The Netherlands

CE
0123

©2019 Physio-Control, Inc. Specifications are subject to change without notice.

Publication Date: 01/2019



PN 3314911-011